

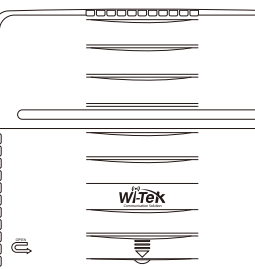





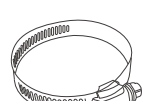

1. Package Contents

1 x Waterproof PoE Switch

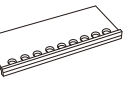

			
1xAC power cord	2xMetal straps	4xScrew with long size	2xHanging installation Kit

			
2xScrew with medium size	1xScrew with small size	1xManger board	1xQuick installation guide

2. Product Overview

• Take WI-PS310GF-O as an example

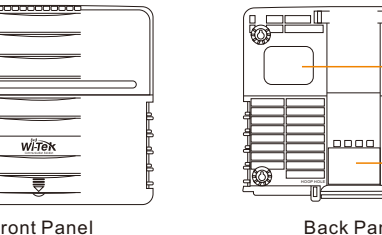

Front Panel: Wall-mount hole, Heat sink, Cable hole



Top Panel: Hanging mount hole

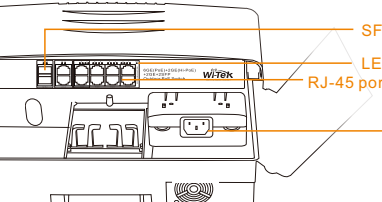

Inside: SFP slot, LED indicators, RJ-45 ports, AC power interface

Light	Instruction	Status	Status Description
LAN Green Light	Signal Indicator	Green Light blink	If the green light does not flicker, please check whether the external network equipment is normal
PoE1-8 Red Light	PoE Power Supply	RedLight ON	If the red light goes out, please check PD
PoE1-8 Green Light	PoE NetworkState	Green lightblinked	If the green light does not flicker, please check whether the externalnetwork equipment is normal
PWR	Power Indicator	Blink Red	The device power on is normal

3. Hardware Installation

• Pole-mount

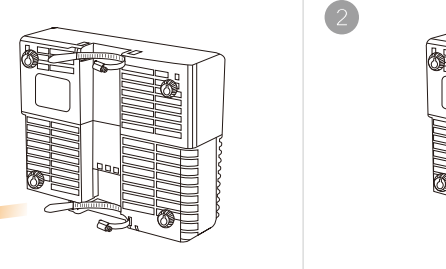

• Wall-mount

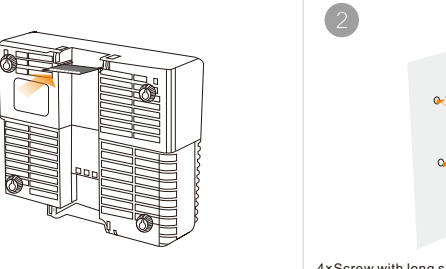
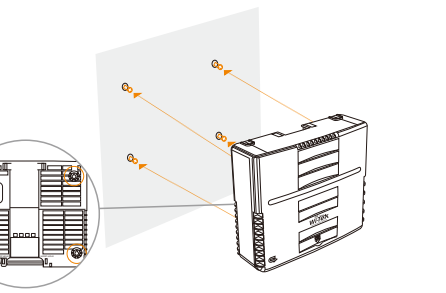

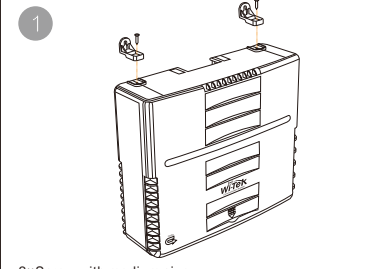

3. Hardware Installation

• Hanging Mount

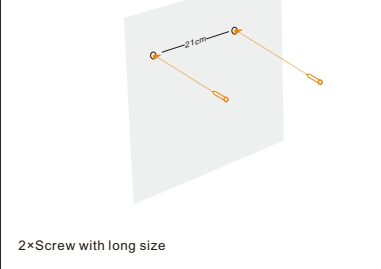

2xScrew with medium size



2xScrew with long size

4. Network Cable Installation

Open the box

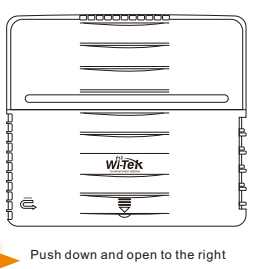

Connect Cable

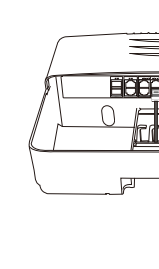

Push down and open to the right

Connect Power

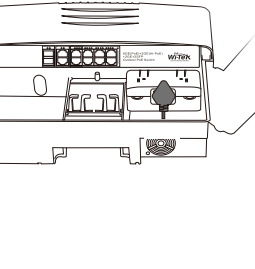

Close the box

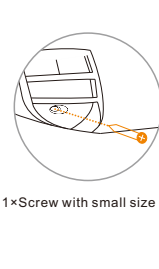

1xScrew with small size

5. Specification

Product	WI-PS210G-O	WI-PS310GF-O
Hardware	V2	V1
Ports	6 100Mbps PoE ports 2 1000Mbps PoE ports 2 1000Mbps Ethernet ports 1 1000Mbps SFP slot	8 1000Mbps PoE ports 2 1000Mbps Ethernet ports 2 1000Mbps SFP slots
PoE Output Port	6*802.3af/at PoE+2*802.3bt 60W PoE	6*802.3af/at PoE+2*802.3bt 60W PoE
Power In	AC 110-240V	AC 110-240V
PoE Watchdog	Yes	Yes
PoE Budget	120W	120W
Application Environment	-30°C ~ 70°C	-30°C ~ 70°C

Warranty Card

Username	
Address	
Telephone No.	
Purchase Shop	
Purchase Address	
Product Model No.	
Purchase Time	
Serial No.	
Dealer Signature	

• If the product defects within three months after purchase, we will provide you a new product of the same model.
 • If the product defects within the three-year warranty period, we will provide the professional maintenance service.
 • Proof of purchase and a complete product serial number are required to receive any services guaranteed as part of the limited warranty.
 • Any other defects that are not caused by workmanship or product quality, such as natural disaster, water damage, extreme thermal or environmental conditions, sticker damaged, warranty card losing will disqualify the product from limited warranty.



Wireless-Tek Technology Limited
 Address: Biaofang Technology Building 402, Bao'an street, Baoan District, Shenzhen City, Guangdong, China
 Website: www.wireless-tek.com
 Tel: 86-0755-32811290
 Email: sales@wireless-tek.com
 Technical Support: tech@wireless-tek.com

