

CCTV Network Solution

Design for SMB Market



Superic Industrial Switch



Cloud Industrial Switch



Outdoor Waterproof Switch



Wireless Transmitter



L2/ L3 Managed Switch



Cloud Easy Smart PoE Switch

Wi-Tek Cloud Platform and Mobile APP

Aim at better supporting and serving project-oriented customers to provide easy and efficient multi-project management and multi-device management tool for free.

✔ Project Management

- Unlimited number of project creation
- Auto project network topology generation
- Real-time network data analysis
- Project share/ handover
- My project map
- Project report

✔ Device Management

- Device status overview
- ONVIF devices (IP Camera) management
- Remote device configuration
- One-key batch device online upgrade
- Device fault alarm
- SD-LAN network

✔ Network Optimization

- Wi-Fi configuration
- Wi-Fi optimization
- Roaming optimization

✔ Practical Toolkit

- Solar PoE Wizard
- CPE Tool
- Roaming Test
- PoE Calculator
- IPC Bandwidth

✔ Real Topology

✔ Alarm Notification



● Key Functions

Wireless Optimization

Wi-Fi optimization plan, intelligently improves your Wi-Fi network performance.



Efficient and Simplified Network Configuration Work

- Step 1.** Plug devices into power source and access to the Internet.
- Step 2.** Enter or scan one of Wi-Tek devices' serial number bar code.
- Step 3.** All Wi-Tek and smart devices will be detected and listed.
- Done.** Done. The network topology is automatically generated.

Oversee Your Network Status via Mobile Phone/Cloud Platform



Multiple Projects Management Easier Than Ever



Projects are all in your grasp!

Fulfill requirements in whole project stage, afford high values and simple experience to your customers through Wi-Tek Cloud.

How does Wi-Tek cloud help you?



Project Preparation Stage



Project Deployment Stage



Project Maintenance Stage

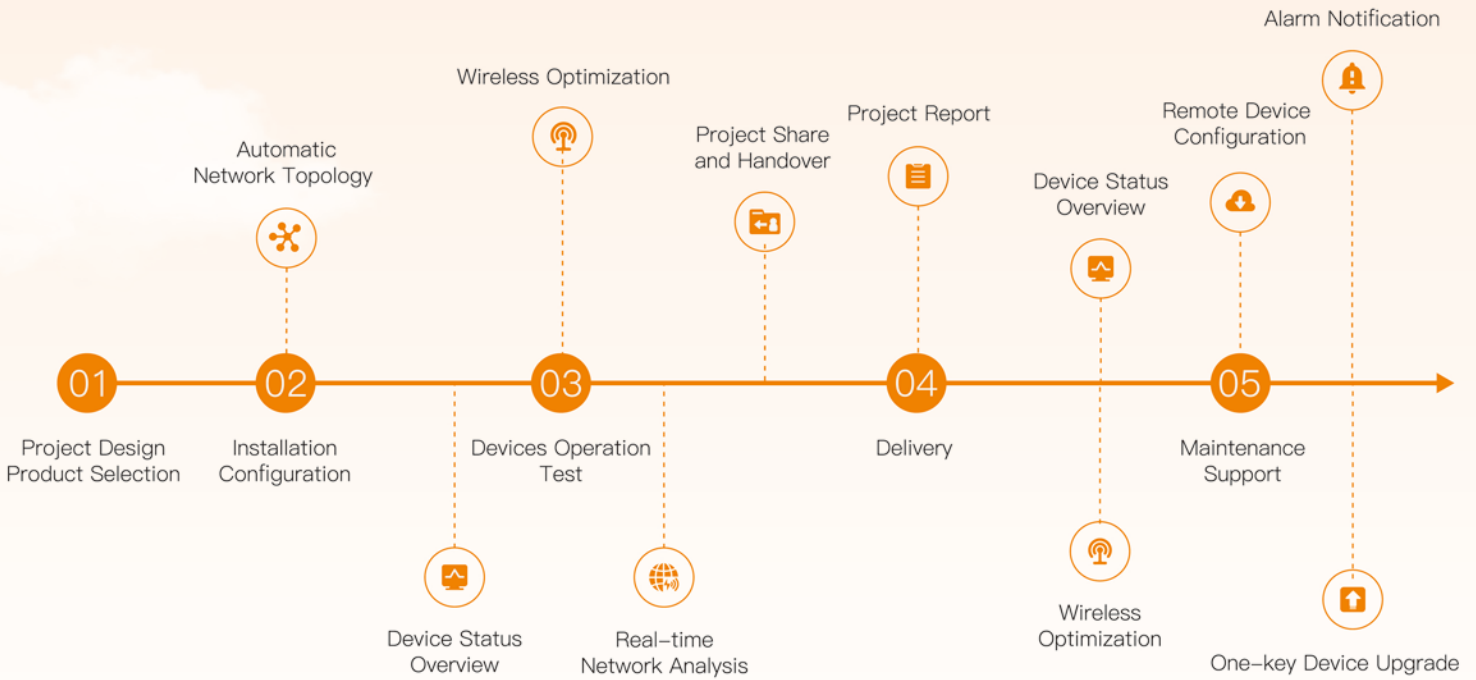

Practical Toolkit

Solar PoE Wizard

Tell you how to choose the model and install quickly.

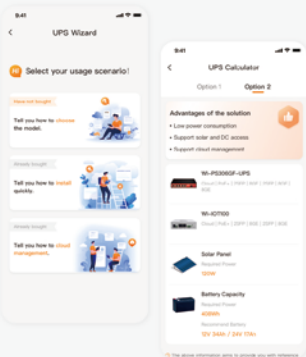

Roaming Test

Test the roaming effect simply and fast.

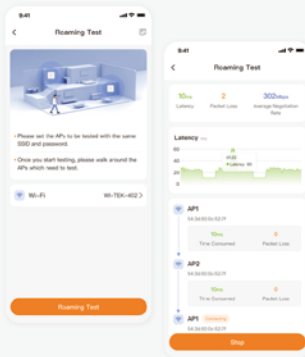

CPE Tool

Tell you how to choose the CPE model and install quickly.

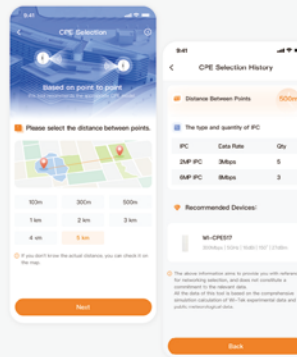

PoE Calculator

Input the PD information to pick appropriate PoE devices.



Cloud CCTV Network Solution

Redefine the CCTV Cloud solution with greater simplicity, security, and scalability.



Cloud remotely management,
save onsite time and cost



Intelligent operation and easy
maintenance by mobile APP



300Mbps to 867Mbps wireless
rate, accurately adapt to
project requirements



Abundant product makes product
selection more complete than ever



Product design based on scenario
and networking requirements



SD-LAN intelligent network realizes
the cross-region intranet interconnection

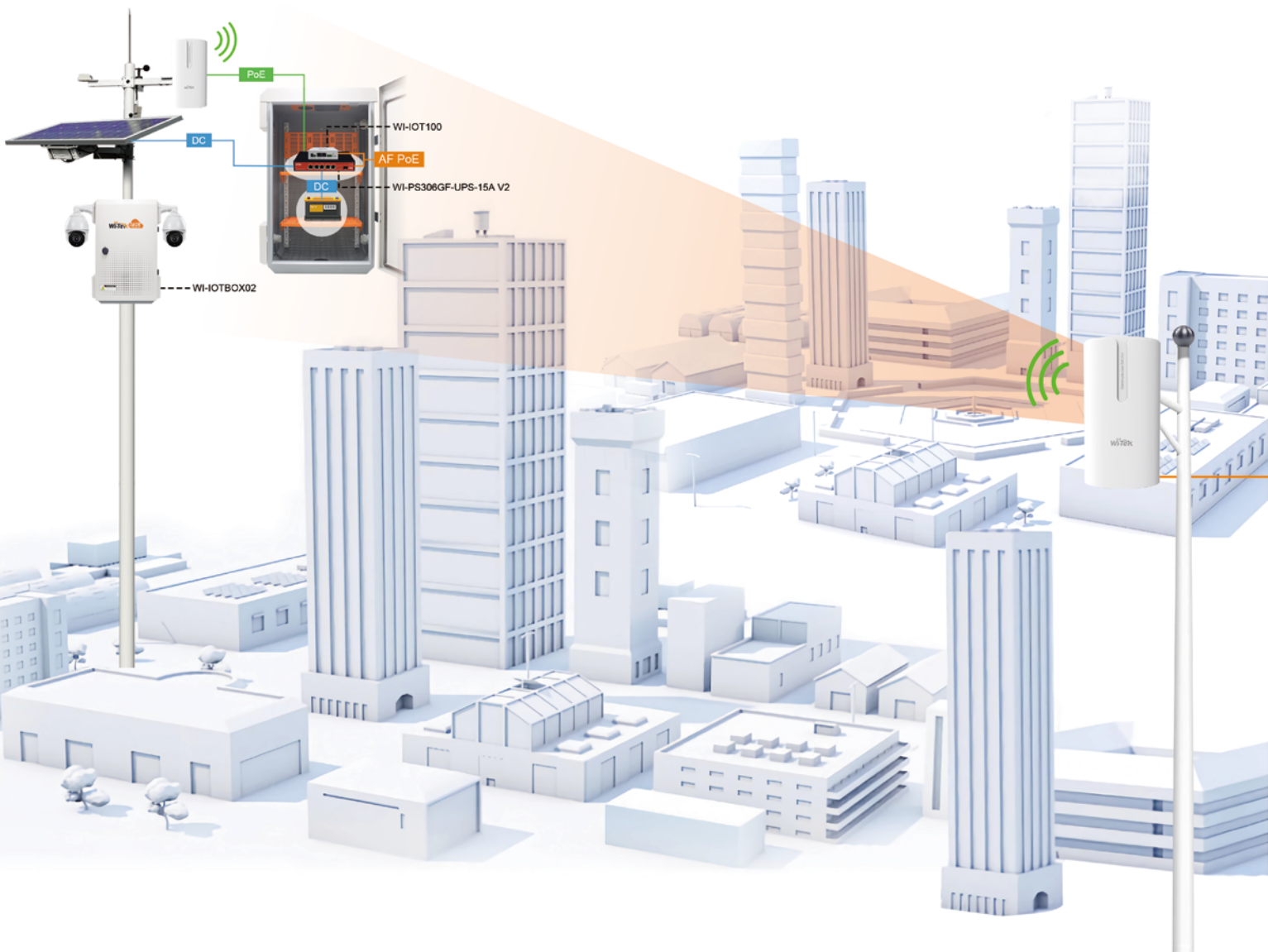

Product Recommendation

Gateway

Cloud Gateway



Core Layer Switch

Cloud L3 Managed Switch



Aggregation Layer

Cloud L2+ Managed Switch

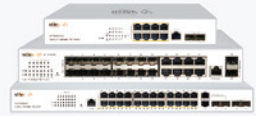

Access Layer



Cloud Easy Smart PoE Switch
 Cloud 250m PoE Switch
 Cloud Outdoor Waterproof PoE Switch
 Industrial Switch
 Solar Powered PoE Switch
 Wireless Transmitter

Accessory



PoE Injector
 PoE Splitter
 PoE Extender
 Media Converter
 IOT Box

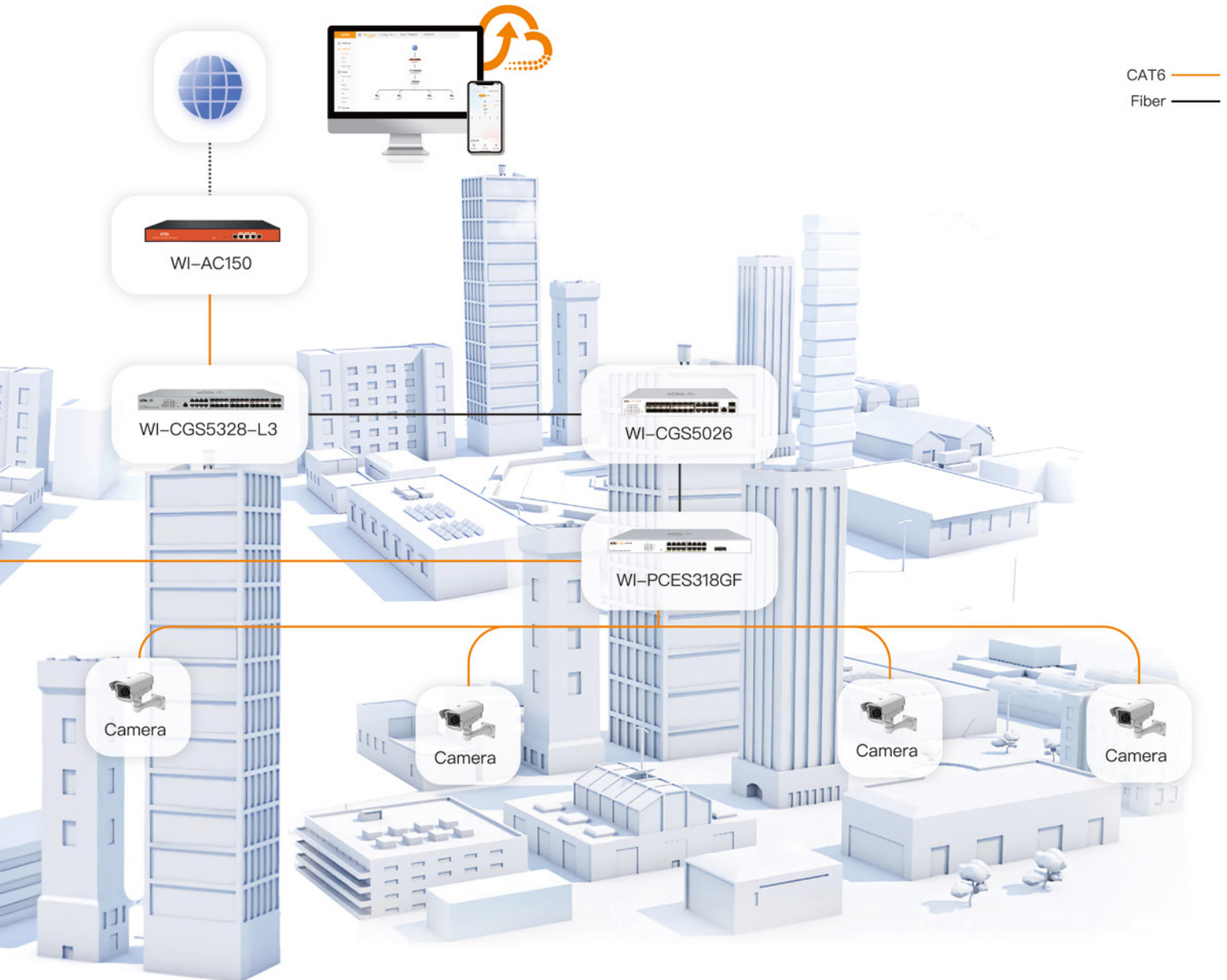

Cloud L3 Managed Switch



Wi-Tek Cloud L3 managed Switch provide Gigabit PoE+ ports and 10G SFP+ slots. Support cloud management which is a high-efficient way for users to manage the network anywhere and anytime. With abundant layer 3 functions, it supports RIP, OSPF, DHCP, etc. helping to build scalable and reliable networks. Robust security functions such as DHCP snooping, ACL, AAA, etc. ensure network data security and reliability.

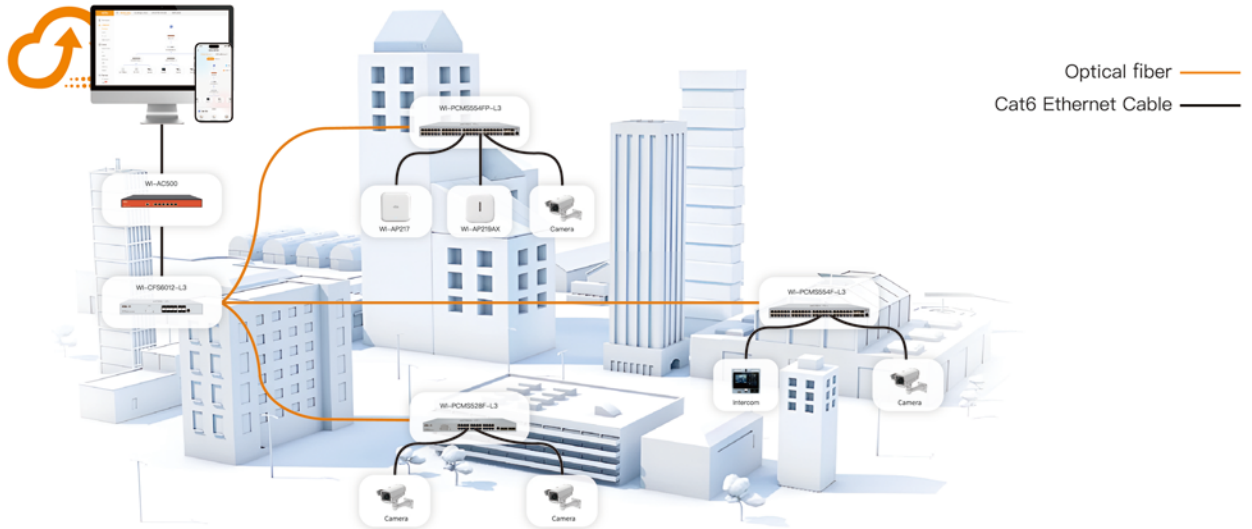





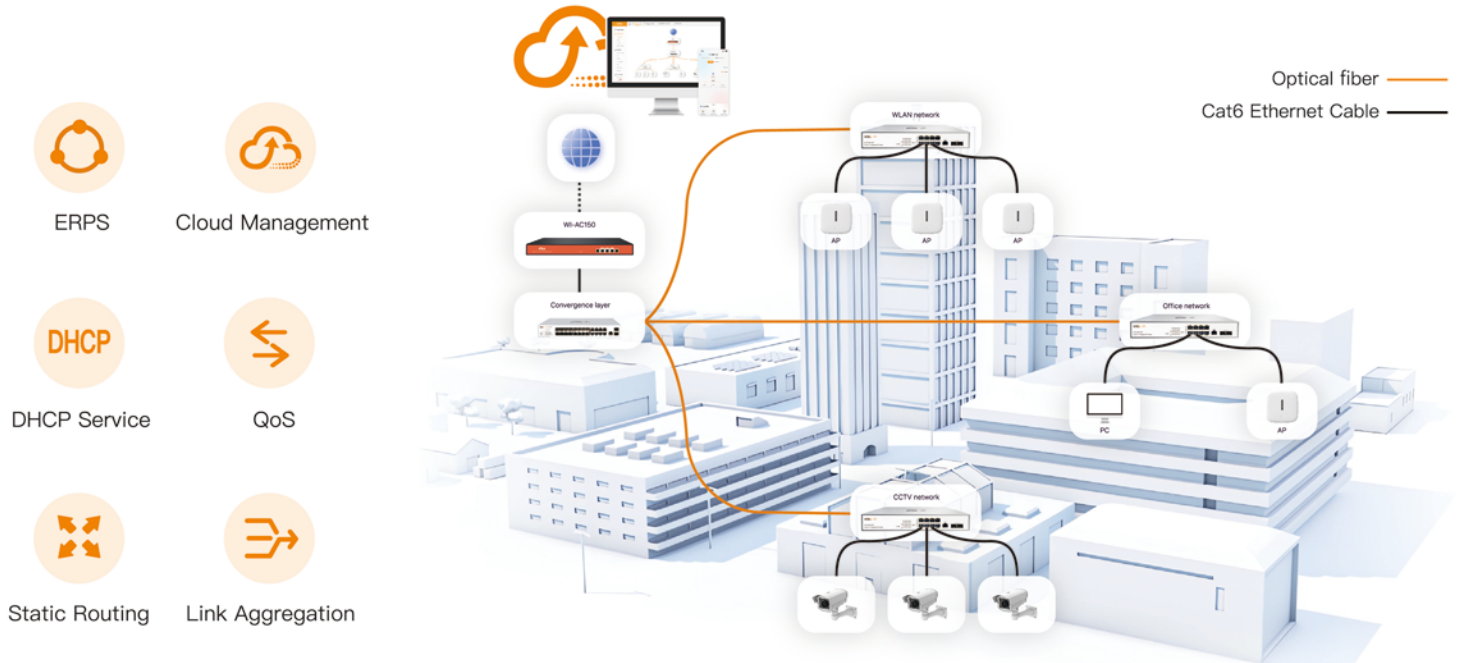

Model	WI-PCMS528F-L3 (V2)	WI-PCMS554F-L3 (V2)	WI-PCMS554FP-L3	WI-CGS5328-L3 (V2)	WI-CFS6012-L3
Interface	24*10/100/1000Mbps PoE+ 4*10Gbps SFP+ Slots	48*10/100/1000Mbps PoE+ 6*10Gbps SFP+ Slots	48*10/100/1000Mbps PoE+ 6*10Gbps SFP+ Slots	8*1000Mbps Combo Ports 16*1000Mbps SFP Slots 4*10Gbps SFP+ Slots	12*10Gbps SFP+ Slots
PoE Ports	24	48	48	-	-
Standard	Port 1-24: 802.3 af/at	Port 1-48: 802.3 af/at	Port 1-48: 802.3 af/at	-	-
PoE Power Budget	370W	370W	880W	-	-
Switching Capacity	128 Gbps	216 Gbps	216 Gbps	128 Gbps	240 Gbps
Packet Forwarding Rate	95.23 Mpps	161 Mpps	161 Mpps	95.23 Mpps	178.6 Mpps
MAC Address Table	16 k	16 k	16 k	16 k	32 k
EWEB Management	Yes	Yes	Yes	Yes	Yes
Onvif	Yes	Yes	Yes	Yes	Yes
Operating Temperature	-10°C~50°C				

Cloud L2+ Managed Switch



Cloud L2+ managed series switches can be managed through the cloud platform, providing a professional and reliable one-stop solution. Integrated L2 and L2+ features such as 802.1Q VLAN, QoS, DHCP server, ERPS, IGMP snooping and static routing provide a reliable network solution for small and medium-sized businesses.



-  ERPS
-  Cloud Management
-  DHCP Service
-  QoS
-  Static Routing
-  Link Aggregation



Model	WI-PCMS310GF (V2)	WI-PCMS328GF (V2)	WI-CGS5026 (V2)
Interface	8*1000Mbps RJ45 Ports 2*Gigabit SFP Slots	24*1000Mbps RJ45 Ports 2*Gigabit Combo ports 2*Gigabit SFP Slots	18*1000Mbps SFP Slots 8*1000Mbps RJ45 Ports
PoE Standard	802.3af/at	802.3af/at	/
PoE Ports	8	24	/
PoE Power Budget	140W	370W	/
Switching Capacity	20Gbps	56Gbps	52Gbps
Packet Forwarding Rate	14.88Mpps	41.66Mpps	38.69Mpps
MAC Address Table	8k	8k	8k
EWEB Management	Yes	Yes	Yes
Operating Temperature	-10°C~50°C		

Cloud L2+ Gigabit Managed Switch





Wi-Tek Cloud L2+ Gigabit Managed Switch provide 8/16/24 Gigabit Ethernet RJ45 ports and multiple Gigabit SFP uplink ports. Wi-Tek Cloud L2+ Gigabit Managed Switch can not only be managed by cloud platforms, but also support rich L2/L2+ management functions, such as static routing, port aggregation, and bandwidth control, providing powerful and reliable performance for your network solution, making it easy to manage and maintain.

Wi-Tek Cloud L2+ Gigabit Managed Switch provides a more efficient, simple, secure, and easy-to-use remote management method. It supports intelligent deployment, automatic networking configuration, abnormal alarms, and other functions.

- 

Cloud Management



Static Routing
- 

DHCP Service



ERPS
- 

Link Aggregation



QoS

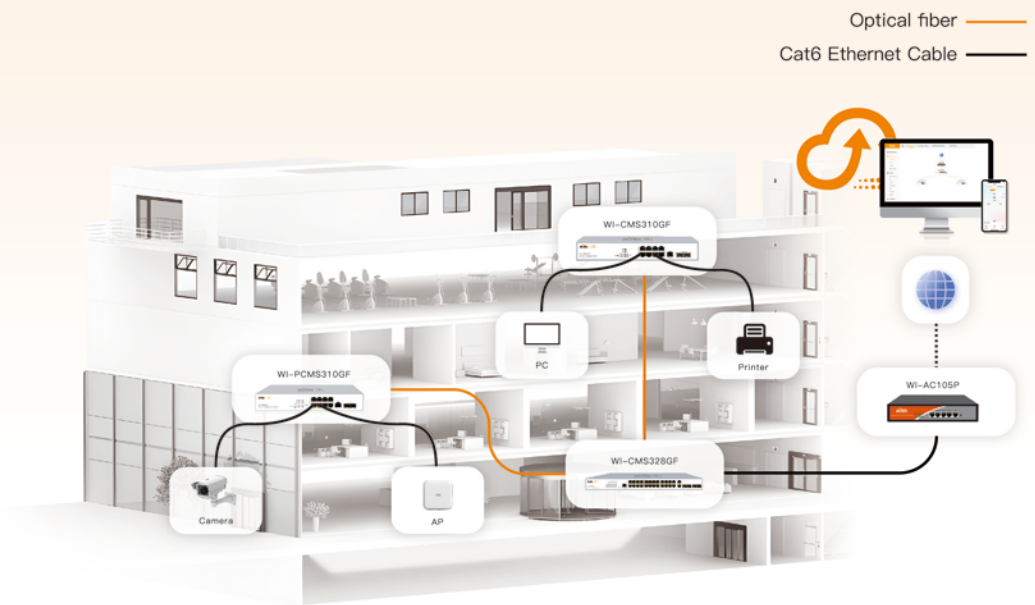

Model	WI-CMS310GF	WI-CMS318GF	WI-CMS328GF
Downlink Ports	8 * 10/100/1000Mbps RJ45 Ports	16 * 10/100/1000Mbps RJ45 Ports	24 * 10/100/1000Mbps RJ45 Ports
Uplink Ports	2 * 1000Mbps SFP Slots	2 * 1000Mbps SFP Slots	2 * 1000Mbps Combo SFP ports 2 * 1000Mbps SFP Slots
Switching Capacity	20 Gbps	36 Gbps	56 Gbps
Packet Forwarding Rate	14.88 Mpps	26.78 Mbps	41.66 Mpps
MAC Address Table	8k	8k	8k
EWEB Management	Yes	Yes	Yes
Operating Temperature	-10°C~50°C		

Cloud Easy Smart Switch



Wi-Tek Cloud Easy Smart PoE switch provides simple, safe, and easy-to-use local WEB and remote management methods and supports smart deployment, abnormal alarm, ONVIF automatic identification of network cameras, automatic shutdown of loop ports, etc. Users can easily use it without professional IT operation and maintenance. Wi-Tek Cloud Easy Smart PoE Switch is the best choice for CCTV and SMB network solution.

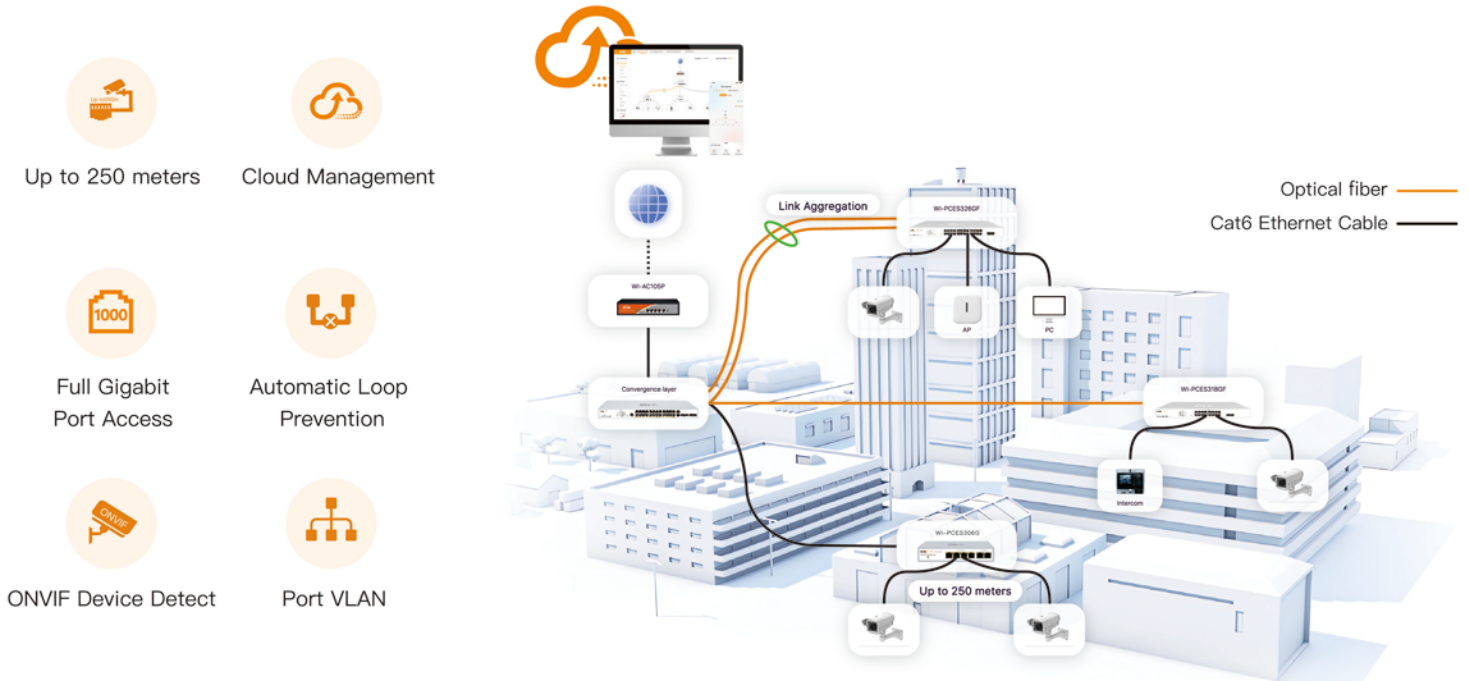

Model	WI-PCES306G(V2)	WI-PCES310GF(V2)	WI-PCES318GF(V2)	WI-PCES326GF(V2)
Interface	6*10/100/1000Mbps RJ45 Ports	8*10/100/1000Mbps RJ45 Ports 2*1000Mbps SFP Slots	16*10/100/1000Mbps RJ45 Ports 2*1000Mbps SFP Slots	24*10/100/1000Mbps RJ45 Ports 2*1000Mbps SFP Slots
PoE Ports (802.3af/at)	4	8	16	24
PoE Power Budget	60W	120W	240W	370W
Switching Capacity	12 Gbps	20 Gbps	36 Gbps	52 Gbps
Packet Forwarding Rate	8.93 Mpps	14.88 Mpps	26.78 Mpps	38.68Mpps
VLAN	Yes	Yes	Yes	Yes
Loop Prevention	Yes	Yes	Yes	Yes
Onvif	Yes	Yes	Yes	Yes
Operating Temperature	-10°C~50°C			

Cloud Easy Smart 250m PoE Switch



Wi-Tek Cloud Easy Smart 250m PoE Switch provides 4/8/16/24 PoE ports, 1/2 1000Mbps SFP slots, some PoE ports can reach up to 90W output, suitable for powering high-power PD. which can meet flexibly the demand of different PoE output in different application scenarios.

This series of switches support cloud management, you can remotely manage your devices in the cloud platform/ mobile APP, providing you with intelligent, simple and easy-to-maintain management measures.



Up to 250 meters



Cloud Management



ONVIF Device Detect



PoE Watchdog



Automatic Loop Prevention



Port VLAN



Model	WI-PCES206	WI-PCES210G	WI-PCES218GF	WI-PCES226GF
Interface	4*10/100Mbps RJ45 PoE Ports 2*10/100Mbps Ethernet Ports	8*10/100Mbps RJ45 PoE Ports 2*10/100/1000Mbps Ethernet Ports	16*10/100Mbps RJ45 PoE Ports 2*1000Mbps Combo SFP	24*10/100Mbps RJ45 PoE Ports 2*1000Mbps Combo SFP
PoE Standard	Port 1-2: Hi-PoE Port3-4: 802.3 af/at 30W	Port 1-2: Hi-PoE Port3-8: 802.3 af/at 30W	Port 1-4: 802.3bt 90W Port 5-16: 802.3af/at 30W	Port 1-4: 802.3bt 90W Port 5-24: 802.3af/at 30W
Switching Capacity	1.2 Gbps	5.6 Gbps	7.2 Gbps	8.8 Gbps
Packet Forwarding Rate	0.89 Mpps	4.17 Mpps	5.36 Mpps	6.56 Mpps
Extend		Yes		
VLAN		Yes		
PD Alive		Yes		
ONVIF		Yes		
Operating Temperature		-10~50℃		

Cloud Smart Outdoor PoE Switch



Cloud Easy Smart 100Mbps Outdoor PoE Series Switch, is a simple and easy-to-manage switch that supports cloud management, configure VLAN, port loop, restart the PoE port, one-click to solve the problem of camera failure, mobile APP remote Maintenance.

With an IP65 weatherproof enclosure, it ensures high-performance operation in harsh environments. The Wi-Tek Cloud Smart Outdoor PoE Switch is designed for outdoor applications like video surveillance and commercial Wi-Fi installations, providing reliable connectivity and durability in outdoor settings.



Cloud Management



ONVIF Device Detect



Up to 250 meters



Waterproof Enclosure



PoE Watchdog

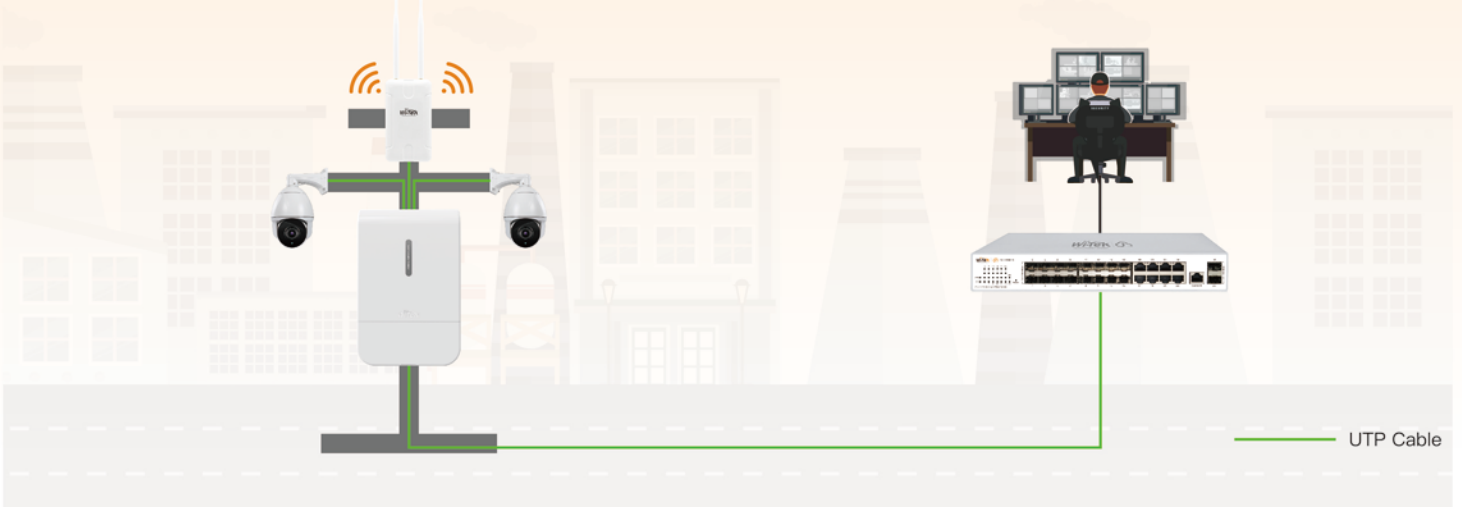

Model	WI-PCES206-O	WI-PCES210G-O
Interface	6*10/100Mbps RJ45 Ports	8*10/100Mbps RJ45 Ports 2*10/100/1000Mbps Uplink Port RJ45
PoE Ports	Port 1-2: Hi-PoE Port 3-4: 802.3af/at	Port 1-2: Hi-PoE Port 3-8:802.3af/at
PoE Power Budget	60W	100W
Switching Capacity	1.2 Gbps	5.6 Gbps
Packet Forwarding Rate	0.89 Mpps	4.17Mpps
PoE Watchdog	Yes	Yes
Onvif	Yes	Yes
Ingress Protection	IP65	IP65

Cloud Outdoor Waterproof Gigabit PoE Switch

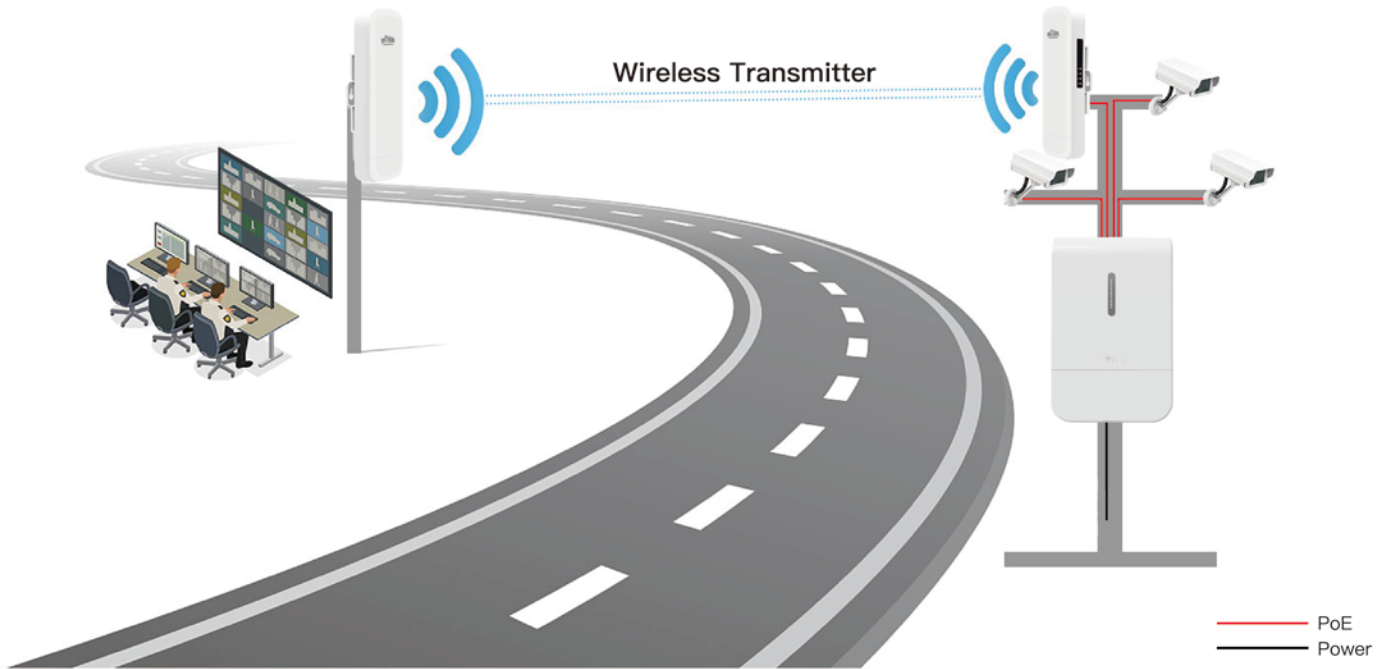

Cloud Management



ONVIF Device Detect



Up to 250 meters



Automatic Loop Prevention



Model	WI-PCES306GF-O	W1-PCES310GF-O	WI-PCMS310GF-O (V2)
Interface	4*10/100/1000Mbps RJ45 Ports 1*10/100/1000Mbps Uplink Port RJ45 1*100/1000Mbps SFP Slot	8*10/100/1000Mbps RJ45 Ports 2*1000Mbps Combo SFP ports	8*10/100/1000Mbps RJ45 Ports 2*1000Mbps SFP Slots
PoE Ports	Port 1: Hi-PoE Port 2-4: 802.3af/at	Port 1-2: Hi-PoE Port 3-8: 802.3af/at	Port 1-8: 802.3af/at
Switching Capacity	12 Gbps	20 Gbps	20 Gbps
Packet Forwarding Rate	8.92 Mpps	14.88 Mpps	14.88 Mpps
PoE Watchdog	Yes	Yes	Yes
Onvif	Yes	Yes	Yes
Ingress Protection	IP65	IP65	IP65
Management category	Easy Smart	Easy Smart	L2

➤ Economic 802.3af/at PoE Switch



Wi-Tek's Economic 802.3af/at PoE Switch Series offers a choice of 4/8/16/24 ports, available in 100Mbps and 1000Mbps speeds. Break free from PoE distance limitations! Wi-Tek provides a cost-effective PoE solution, empowering your IP-camera up to 250m away. Abundant DIP switch modes like Extend Mode, PoE Watchdog Function, and Port isolation, provide a lot of value for basic networking needs, creating a easy-to-use and reliable surveillance network to grow your business.



Extend your network up to 250 meters long distance with VLAN function



Port Isolation for higher security



PoE watchdog can detect and reboot unresponsive PD

Extend Mode for Longer Distance

Default 100 Meters

Extend 250 Meters



Model	WI-PS205H	WI-PS210H	WI-PS518GH	WI-PS526GH
Interface	4*100Mbps PoE Ports 2*100Mbps Ethernet Ports	8*100Mbps PoE Ports 2*100Mbps Ethernet Ports	16*100Mbps PoE Ports 1*1000Mbps Ethernet Port 1*1000Mbps Combo Port	24*100Mbps PoE Ports 1*1000Mbps Ethernet Port 1*1000Mbps Combo Port
PoE Power Budget	42W	62W	197W	198W
PoE Watchdog	Yes			
250m	Yes			
VLAN	Yes			

➤ Economic 802.3af/at PoE Switch

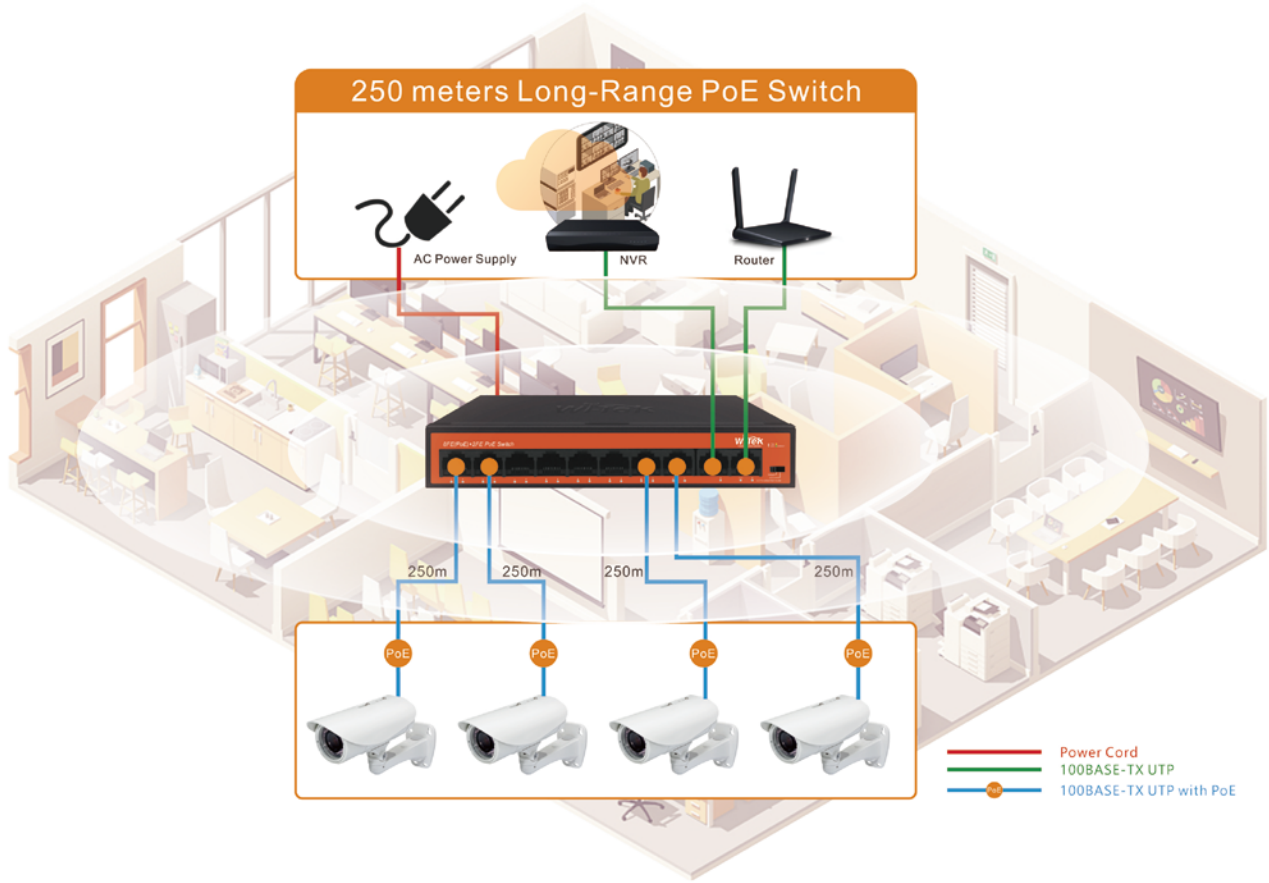

Model	WI-PS305GH	WI-PS308GH	WI-PS309GFH	WI-PS318GFH	WI-PS326GFH
Interface	4*1000Mbps PoE Ports 1*1000Mbps Ethernet Port	8*1000Mbps PoE Ports 2*1000Mbps Ethernet Ports	8*1000Mbps PoE Ports 1*1000Mbps Ethernet Port 1*1000Mbps SFP Slot	16*1000Mbps PoE Ports 2*1000Mbps Combo Ports	24*1000Mbps PoE Ports 2*1000Mbps SFP Slots
PoE Power Budget	57W	62W	64W	197W	252W
PoE Watchdog			Yes		
250m			Yes		
VLAN			Yes		

➤ Unmanaged 250-meter Long-Range PoE Switch



Wi-Tek Unmanaged 250-meter Long-Range PoE Switch provide 4/8 10/100Mbps PoE RJ-45 ports, 2 100/1000Mbps Uplink Ports, which can meet flexibly the demand of different PoE Input in different application scenarios. In addition, Wi-Tek Long-Distance PoE Switch can extend the data transmission distance to 250m, breaking the distance limit and improving the device availability. At the same time, Wi-Tek Long-Distance PoE Switch provide valuable features such as PoE Watchdog, Port isolation, creating easy-to-use network to grow your business.



Extend your network up to 250m



PoE watchdog can detect and reboot unresponsive PD



Port Isolation for higher security

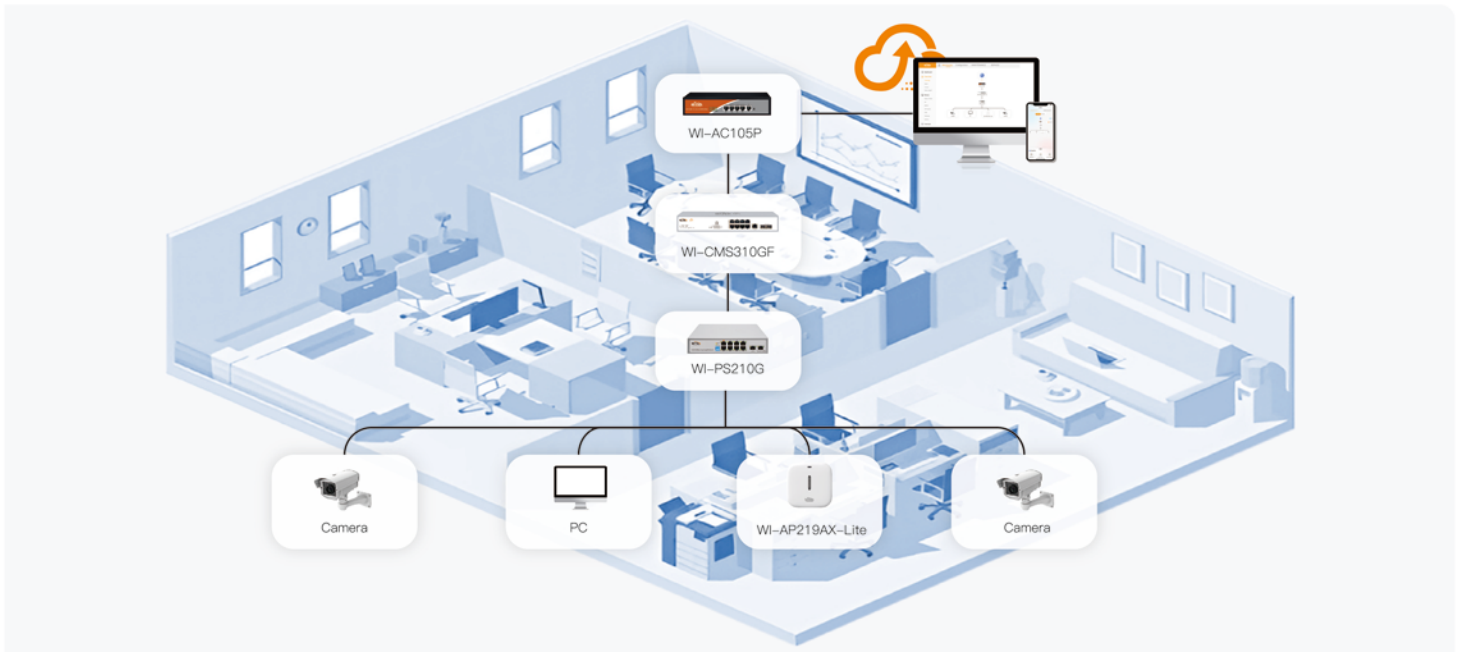

Model	WI-PS205(V3)	WI-PS210(V3)	WI-PS210G(V3)
Ports	4*10/100Mbps PoE Ports 2*100Mbps Ethernet RJ45 Ports	8*10/100Mbps PoE Ports 2*100Mbps Ethernet RJ45 Ports	8*10/100Mbps PoE Ports 2*1000Mbps Ethernet RJ45 Ports
PoE Ports	4	8	8
PoE Power Budget	60W	110W	110W
Extend		Yes	
PoE Watchdog		Yes	
VLAN		Yes	

Multi-WAN Gateway with Cloud Management



Wi-Tek's gateway is an intelligent network device integrating AP management system and gateway features and supporting up to 2.5Gbps connection on LAN and WAN ports for ultrafast wired network. They are featured with multiple VPN protocols, multi WAN, abundant security strategies, behavior management and other enterprise level function, making it an idea choice for many application scenarios such as hotel, office and SMB network. As the gateway supports cloud management, users can quickly complete network device configuration, remote management as well as maintenance via cloud web or app anywhere and anytime, maximizing the convenience and flexibility.

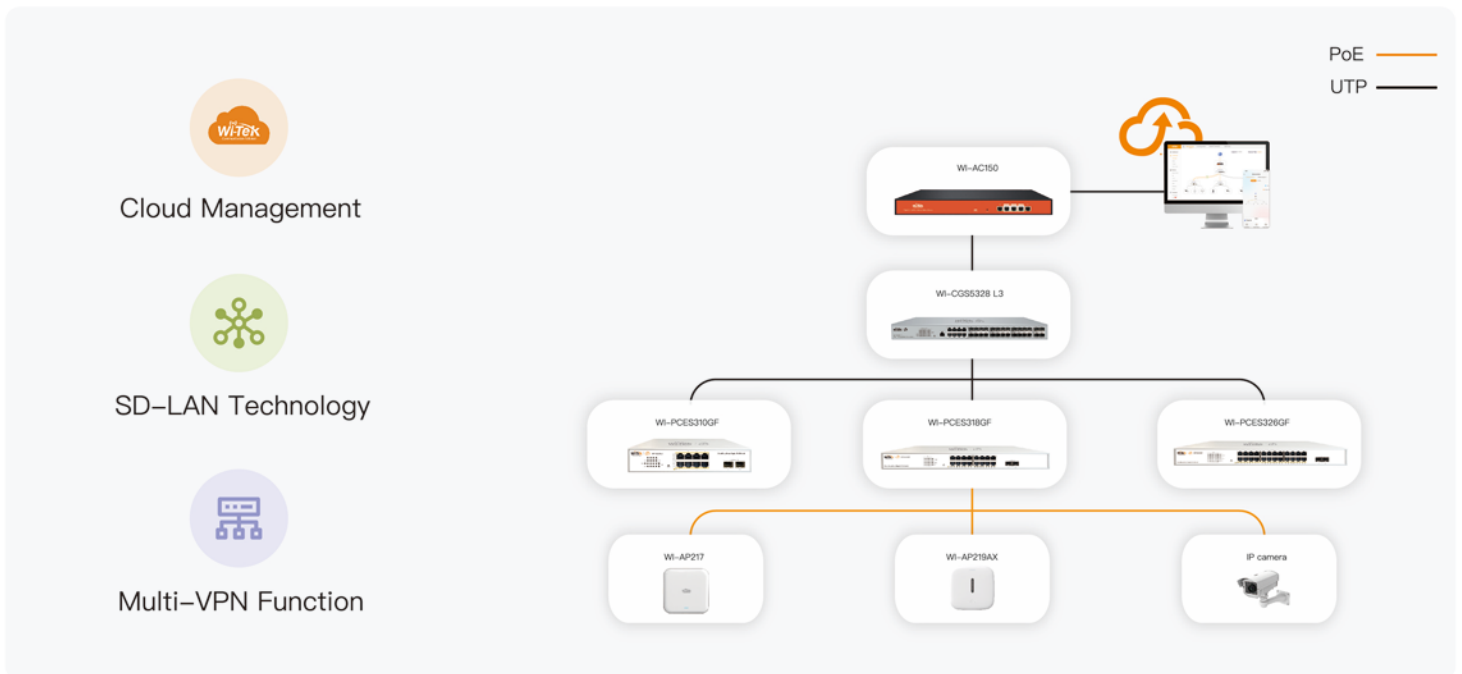

Model	WI-AC105P	WI-AC108P	WI-AC150	WI-AC500
Interface	5*1000Mbps Ethernet ports 4 WAN ports (Default: 1 WAN port, 4 LAN ports)	9*1000Mbps Ethernet-ports (Default: 1 WAN port, 8 LAN ports)	5*1000Mbps Ethernet ports 4 WAN ports (Default: 1 WAN port, 4 LAN ports)	6 x 2.5G Ethernet Ports Up to 5 WAN ports (Default: 1 WAN port, 5 LAN ports)
PoE Output Port	4*802.3af/at PoE	8*802.3af/at PoE	N/A	N/A
Manage AP(Max)	32APs	64APs	150APs	500 APs
Power Supply	AC:100-240V	AC:100-240V	AC:100-240V	AC:100-240V
Power Consumption	65W (With PoE load)	150W (With PoE load)	<25W	< 15W

Superic Industrial Switch







To meet the requirements of industrial application scenarios, such as roadway, community, parking lot, plaza, etc, Wi-Tek developed the Superic series industrial switch with superior quality, standard design, stable operation, and simplified management.

Industrial grade CPU, redundant power input and metal housing design, the device can work stably in harsh environments.

Wi-Tek provides superic industrial switches with abundant L2 management functions, such as 802.1Q VLAN, QoS, ACL, IGMP Snooping, STP, ETC.



-  -40~75°C Working Temperature
-  6kV Surge Immunity
-  Redundant Power Input Interface
-  Up to 802.3bt 90W PoE power
-  ESD 15kV ESD Protection

Test Item	Execute Standard	Result
Surge Immunity	IEC 61000-4-5, 6kV/4kV (8/20us)	✓ Pass
RS	IEC 61000-4-3, 80 MHz-1 GHz/10V/m	✓ Pass
EFT	IEC 61000-4-4, 4k, 2k	✓ Pass
CS	IEC 61000-4-6, 10V	✓ Pass
ESD	IEC 61000-4-2, 8kV/15kV	✓ Pass
Shock	IEC 60068-2-27	✓ Pass
Free fall	IEC 60068-2-32	✓ Pass
Vibration	IEC 60068-2-6	✓ Pass



Unmanaged Switch

Model	SP3006F	SP3010F	SP3006F-BT	SP3010F-BT	SP3018F
Downlink Ports	4*10/100/1000 Base-T PoE+ RJ-45	8*10/100/1000 Base-T PoE+ RJ-45	4*10/100/1000 Base-T PoE++ RJ-45	4*10/100/1000 Base-T PoE+ RJ-45 and 4*10/100/1000 Base-T PoE++ RJ-45	16*10/100/1000 Base-T PoE+ RJ-45
Uplink Ports	2*1000 Mbps Base-X SFP	2*1000 Mbps Base-X SFP	2*1000 Mbps Base-X SFP	2*1000 Mbps Base-X SFP	2*1000 Mbps Base-X SFP
DIP Mode	VLAN/Extend/PoE Watchdog/QoS				Link Aggregation /Extend PoE Watchdog/QoS
Surge Immunity	6kV				
Operating Temperature	-40~75°C				

Superic Industrial Switch



Control

1.Port IP Surveillance Network Application

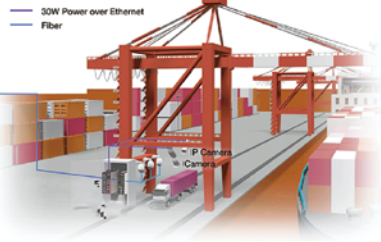

2.Transportation IP Surveillance Network Application

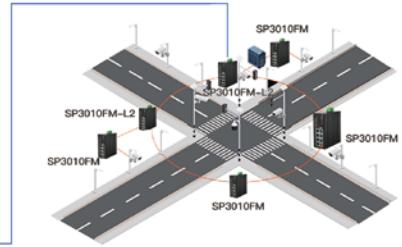

L2 managed Switch

Model	SP3006FM-L2	SP3010FM-L2	SP3012FM-L2	SP3018FM-L2	SP5012FM-L2
Hardware version	V2	V2	V2	V1	V1
Downlink port	2*10/100/1000 Base-T PoE++ RJ-45 and 2*10/100/1000 Base-T PoE+ RJ-45	2*10/100/1000 Base-T PoE++ RJ-45 and 6*10/100/1000 Base-T PoE+ RJ-45	2*10/100/1000 Base-T PoE+ RJ-45 and 8*10/100/1000 Base-T PoE+ RJ-45	16*10/100/1000 Base-T PoE+ RJ-45	8*10/100/1000 Base-T PoE+ RJ-45
Uplink Ports	2*1000/2500 Mbps Base-X SFP	2*1000/2500 Mbps Base-X SFP	4*1000/2500 Mbps Base-X SFP	2*1000/2500 Mbps Base-X SFP	4*1000/2500/10000 Mbps Base-X SFP
Surge Immunity	6kV				
Operating Temperature	-40~75°C				



Easy Smart Managed

Model	SP3006FM	SP3010FM
DIP Mode	4*10/100/1000 Base-T PoE+ RJ-45	8*10/100/1000 Base-T PoE+ RJ-45
Uplink port	2*1000 Mbps Base-X SFP	2*1000/2500 Mbps Base-X SFP
Surge Immunity	6kV	
Operating Temperature	-40°C~75°C	

Cloud L2 Managed Industrial Switch



- Cloud L2 Management Industrial switch can work with Wi-Tek cloud platform, makes it can be easily and remotely managed.
- Flexible installation method, support wall mounting and DIN-Rail mounting.
- Industrial grade CPU, redundant power supply design ensure the stable operation of the project even in harsh environment.
- Wi-Tek provide industrial switches with abundant L2 management functions, such as QVLAN, QoS, ACL, IGMP Snooping, STP, ETC.

- Cloud Management
- Smart DIP Mode
- Up to 802.3af/at/bt
90W PoE
- Automatic identification
of ONVIF

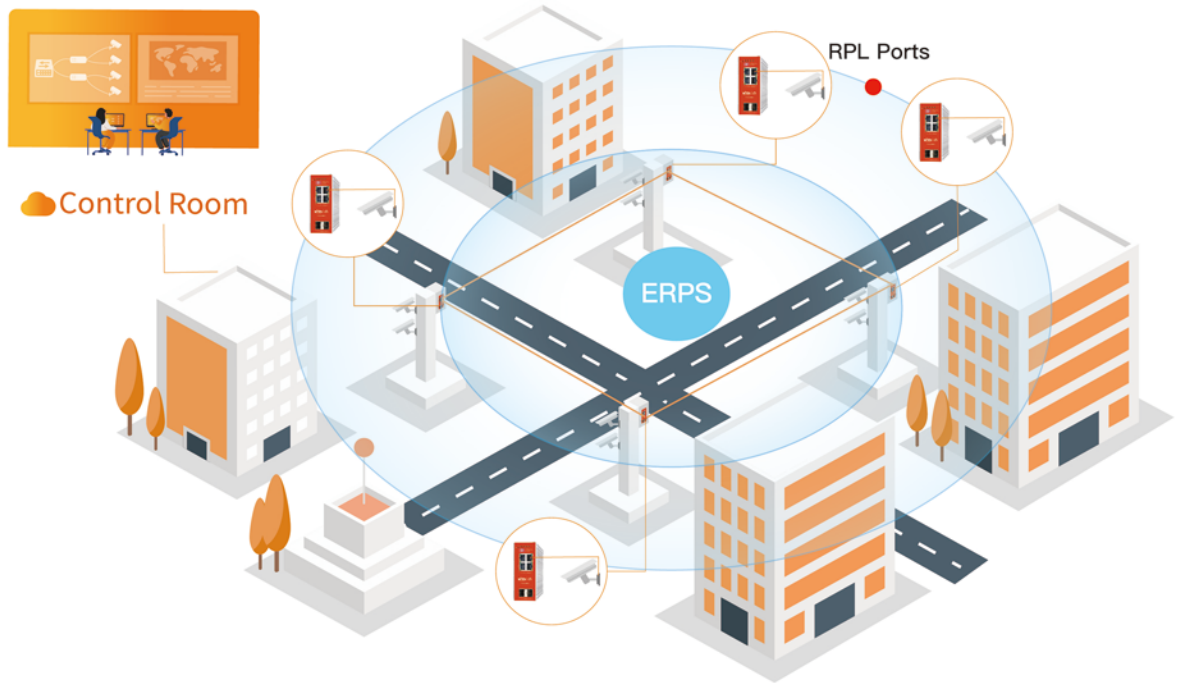

Model	WI-PCMS306GF-I	WI-PCMS310GF-I	WI-PCMS312GF-BT-I
Ports	4*10/100/1000 Base-T PoE+ RJ-45 2*1000 Base-X SFP	8*10/100/1000 Base-T PoE+ RJ-45 2*1000 Base-X SFP	8*10/100/1000 Base-T PoE++ RJ-45 4*1000 Base-X SFP
PoE Power Budget	120W	185W	460W
Cloud Management	Yes	Yes	Yes
DIP Mode	Fast Ring/SCP	Fast Ring/SCP	Fast Ring/SCP
Surge Immunity	6kV		
Operating Temperature	-40°C~75°C		

Cloud Industrial Flat-type Easy Smart Switch



The Wi-Tek Cloud Industrial Flat-type Easy Smart Switch offers 8 1000Mbps PoE ports with 2 ports up to 90W of PoE power, providing flexible and high-performance full-gigabit access and uplink ports. Professional design provides a flexible, easy-to-use, and reliable industrial network solution. The switch provides simple, safe, and easy-to-use local WEB and remote management methods, supports smart deployment, abnormal alarm, ONVIF automatic identification of network cameras, etc. Wi-Tek Cloud Industrial Flat-type Easy Smart Switch is the best choice for industrial network solutions and projects of harsh application scenarios such as factory and park.



Cloud Management



-40~75°C Operating Temperature



Alarm Notification



Low Temperature Fan Not Working



High Temperature Fan Start to Working



Redundant Input Power



DIN-rail/Magnetic Mounted



Temperature Humidity Monitoring



Full Gigabit Port Access



Model	WI-PCES310GF-F
Downlink Ports	8 *10/100/1000Mbps RJ45 Ports
Uplink Ports	2 *1000Mbps SFP Slots
PoE Power Budget	355W
Switching Capacity	20 Gbps
Packet Forwarding Rate	14.88 Mpps
Surge Immunity	6kV
Operating Temperature	-40°C~75°C

➤ Hardened PoE Switch

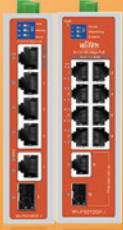

- Hardened PoE switch is design to provide transport network solution for wireless coverage and CCTV market.
- $-30^{\circ}\text{C}\sim 65^{\circ}\text{C}$ working temperature, meet the most requirement of project site environment.
- Flexible installation method, support wall mounting and DIN-Rail mounting.
- It support 802.3af/at/bt 90W PoE, can meet the requirement of high power compliant devices, such as PTZ speed dome, high power wireless access



$-30\sim 65^{\circ}\text{C}$
Working Temperature



802.3af/at/bt 90W PoE



Smart DIP Mode

802.3bt 90W PoE Output

- PTZ Speed Dome
- Digital Signage
- Digital Signage
- 802.11ax AP

802.3at 30W PoE Output

- IP Camera
- VoIP Phone
- Alarm System
- Wireless AP



Model	WI-PS206GF-I (V2)	WI-PS212GF-I (V2)
Ports	4*10/100 Base-T PoE RJ-45 1*1000 Base-X SFP 1*10/100/1000 Base-T RJ-45	8*10/100 Base-T PoE RJ-45 1*1000 Base-X SFP 1*10/100/1000 Base-T RJ-45
PoE	Port 1: 802.3 af/at/bt PoE 90W Ports 2-4: 802.3 af/at PoE 30W	Port 1-2: 802.3 af/at/bt PoE 90W Ports 3-8: 802.3 af/at PoE 30W
DIP Mode	VLAN/ PoE Watchdog/Extend	VLAN/ PoE Watchdog/Extend
Surge Immunity	6kV	
Operating Temperature	$-30^{\circ}\text{C}\sim 65^{\circ}\text{C}$	

Solar Powered PoE Switch



Wi-Tek Solar Powered PoE Switch series is designed for CCTV surveillance and wireless network, including unmanaged and layer 2 managed solar PoE switches. Based on its green energy, it can be charged by the inexhaustible and natural source of energy—solar power. It can conserve green energy economically and power the remote IP cameras and wireless AP, especially used for expansive applications such as dams, forests, deserts, national parks, and highways.



- Built-in MPPT solar controller
- Zero-carbon and stable power supply
- Working status monitoring via LED indicator



Product	WI-PS306GF-UPS	WI-PS306GF-UPS-15A	WI-PMS306GF-UPS-I	WI-PMS310GF-UPS+
Version	V3	V2	V1	V2
Interface	1*1000Mbps 802.3bt 60W PoE RJ45 2*1000Mbps 802.3at 30W PoE RJ45 2*1000Mbps 802.3at 30W PoE or 24V passive 24W PoE RJ45 1*1000Mbps SFP	1*1000Mbps 802.3bt 90W PoE RJ45 2*1000Mbps 802.3at 30W PoE RJ45 2*1000Mbps 802.3at 30W PoE or 24V passive 24W PoE RJ45 1*1000Mbps SFP	2*1000Mbps 802.3bt 90W PoE RJ45 2*1000Mbps 802.3at 30W PoE or 24V passive 24W PoE RJ45 2*1000Mbps SFP	8*1000Mbps 802.3at 30W PoE or 24V passive 24W PoE RJ45 2*1000Mbps SFP
Power Budget	65W	120W	120W	120W
Power Supply	1 *Photovoltaic Input 1*DC input 1*12V/24V Battery charging & discharging	2*Photovoltaic Input 1*12V/24V Battery charging & discharging	2*Photovoltaic Input 1* DC input 1*12V/24V Battery charging & discharging	2*Photovoltaic Input 1*AC input 2*12V/24V Battery charging & discharging
Charge Current	5A max	15A max	15A max	15A max
Battery Capacity	50Ah max	500Ah max	500Ah max	500Ah max
Management	/	Cloud management with WI-IOT100 RS-485	L2 WEB management	L2 WEB management

Smart IoT Box



Wi-Tek's Smart IoT Box is an all-weather outdoor electrical equipment protection box designed for outdoor use in the outdoor environment. It has waterproof, dustproof, heat dissipation, anti-ultraviolet, anti-theft, anti-rust, acid and alkali corrosion, anti-electromagnetic interference (anti-lightning EMP), modular structure design in the box, electrical equipment can be installed vertically or horizontally according to the situation.



Waterproof



Heat Dissipation



Firm Structure



Modular Installation



Lightning Protection



Dustproof



Anti-corrosion



Model	WI-IOTBOXMINI	WI-IOTBOX01	WI-IOTBOX02	WI-IOTBOX03
Overall Size (W*H*D)	300*300*206.5mm	300*400*206.5mm	400*600*256.5mm	500*700*286.5mm
Weight(kg)	5.5	7.2	12.6	17.1
Thickness	1.2mm			
Material	SUS430/Stainless Steel			
Color	Light Grey + Grey			
Protect Level	IP65, IK10			
Accessories	Microswitch, Fan, Miniature circuit breaker, Waterproof connector, Grounding connector, thermostat (optional), heater(optional)			
Surface Treatment	Electrostatic Spraying			
Installation	Pole/Wall/Floor-mounted			
Application	Junction, Distribution, Electrical, Battery, Control, Monitoring etc. Outdoor waterproof Enclosure Box.			

Wireless Long-range Transmitter for CCTV



Wi-Tek Wireless Transmitter is specialized designed for rural Internet access, long distance wireless data transmission, wireless coverage extension and other industrial wireless solutions. It is widely used in various fields of communication. Wi-Tek free Cloud quick installation and configuration provide reliable performance, visual management and remote access to enable companies to focus on growing their business.

Wireless Transmission

- Plug and play
- Easy to maintenance
- Efficient and safe
- Devices can be reused

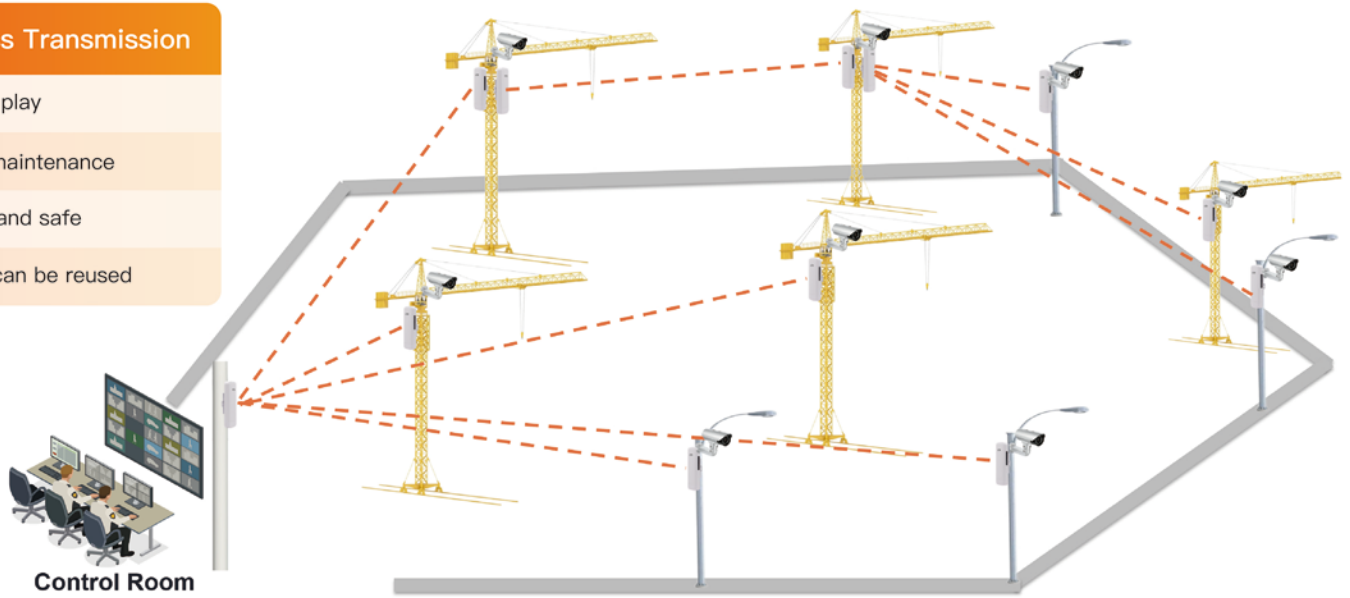

Model	WI-CPE800-KIT	WI-CPE517	WI-CPE821
Hardware	V3	V2	V1
Interface	1*1000Mbps 802.3af PoE IN Ethernet port 1*1000Mbps Ethernet Port	1*100Mbps 24V PoE IN Ethernet port 1*1000Mbps Ethernet Port	1*1000Mbps 802.3at PoE IN Ethernet port
Wireless Speed	867Mbps	300Mbps	867Mbps
Wireless Frequency	5.180GHz~5.825GHz	5.180GHz~5.825GHz	5.180GHz~5.825GHz
Half Power Beamwidth	H: 33° V: 33°	H: 150° V: 8°	H: 360° V: 9°
Recommend Distance	5km	5km	2km
Cloud Management	Yes		

Wireless Long-Range Transmitter for CCTV

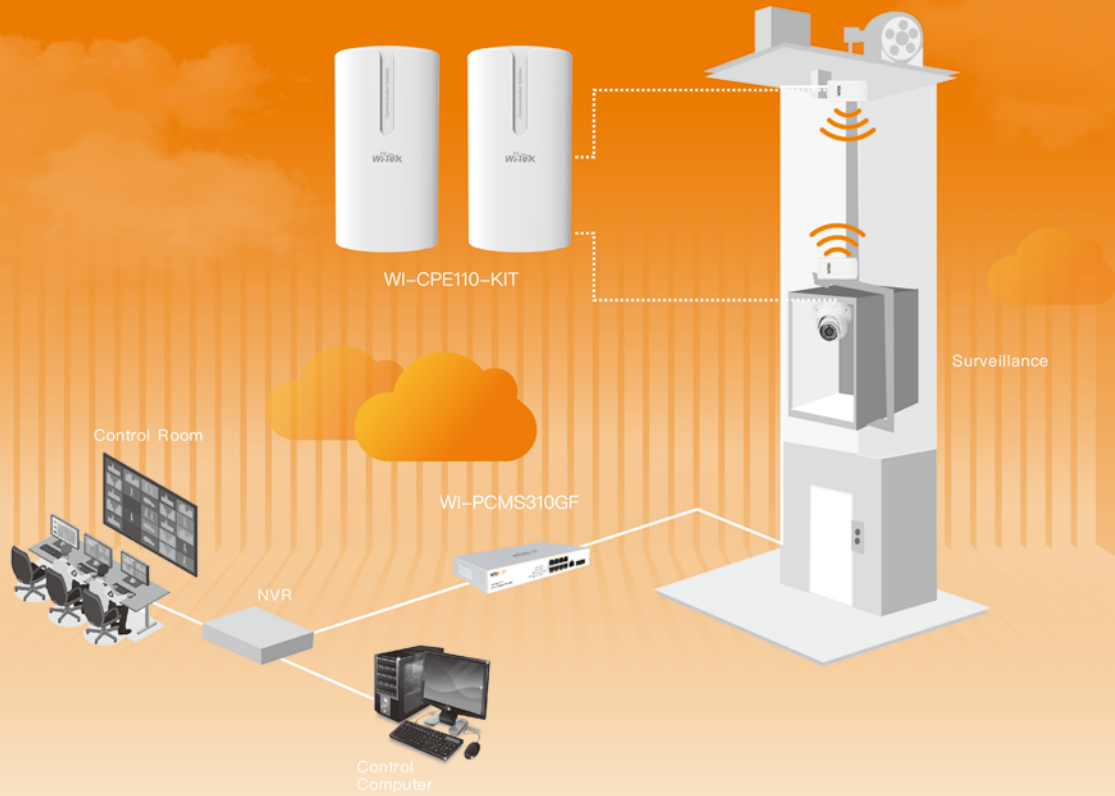

PTP/PTMP transmission



IP65 waterproof enclosure



Cost-effective solution



Model	WI-CPE110-KIT	WI-CPE111-KIT	WI-CPE511H-KIT	WI-CPE513P-KIT
Hardware	V2	V3	V2	V3
Interface	1*100Mbps 24V PoE IN Ethernet port 1*100Mbps Ethernet Port	1*100Mbps 24V PoE IN Ethernet ports 1*100Mbps Ethernet Port	1*100Mbps 24V PoE IN Ethernet ports 1*100Mbps Ethernet Port	1*100Mbps 802.3at PoE IN Ethernet port 1*100Mbps 802.3af PoE out Ethernet port
Wireless Speed	300Mbps	300Mbps	867Mbps	300Mbps
Wireless Frequency	2.412GHz~2.484GHz	2.412GHz~2.484GHz	5.180GHz~5.825GHz	5.180GHz~5.825GHz
Half Power Beamwidth	H: 65° V:65°	H: 65° V:65°	H: 30° V: 30°	H: 60° V: 15°
Recommend Distance	1km	2km	3km	5km
Cloud Management	Yes			

300Mbps LTE 4G Wireless Router



Enjoy seamless connectivity with our advanced 4G LTE Router. With lightning-fast download speeds up to 300Mbps and reliable upload speeds of 50Mbps, you'll never miss a beat. Our router is designed to be backward compatible with 4G/3G networks, ensuring uninterrupted connections. Simply plug in your card for instant network access, anytime, anywhere. Perfect for both home and remote work environments, our 4G Router enhances productivity and guarantees a consistent connection.



Plug and Play



300Mbps Wireless Speed



Support PoE/ 12V DC Output



Model	WI-LTE110-O	WI-LTE115-O	WI-LTE117-O	WI-LTE113-O	WI-LTE300
Hardware	V2	V2	V2	V1	V2
Interface	(2)10/100M Base-T Ethernet Ports	(1)10/100M Base-T Ethernet Port	(2)10/100M Base-T Ethernet Ports	(1)10/100M/1000M Base-T Ethernet Port	(3)10/100M Base-T Ethernet Ports
Power Supply	DC IN 12V/1A or 24V Passive PoE IN	DC IN 12V/1.5A	DC IN 48-54V/2A MAX or 802.3af/at PoE IN	802.3af/at PoE or 24V Passive PoE IN	DC IN 12V/1A
4G Antenna Gain	2dBi	5dBi	5dBi	19dBi	5dBi
LTE Category	CAT 4	CAT 4	CAT 4	CAT 6	CAT 4
Waterproof	IP65	IP65	IP65	IP65	No
PoE/DC Output	No	(1)DC Out 12V/1A	(1) PoE Output	No	No
Cloud Management	Yes	Yes	Yes	Yes	Yes

Wireless Mesh Wi-Fi System



Unpack your Wi-Tek Cloud device, download the app, and then effortlessly proceed with the intuitive on-screen prompts. The Wi-Tek Cloud app is designed to streamline the setup process, ensuring your system is operational within minutes.



Cloud Management



One-click Mesh Function



SD-LAN technology



PoE or DC IN Power

Quick Setup on Wi-Tek Cloud APP



1 Ensure that the device is powered on and is connected the Internet.



2 Open the installed Wi-Tek Cloud APP.

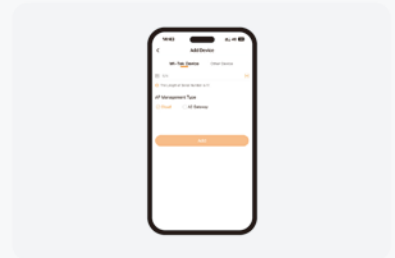

3 Follow the prompts to set up step by step.



Model	WI-AX1800M (V2)	WI-AP718M	WI-AP719MP	WI-AP717MP(V2)
Wireless Standards	IEEE 802.11a/b/g/n/ac/ac wave2/ax	IEEE 802.11a/b/g/n/ac	IEEE 802.11a/b/g/n/ac/ac wave2/ax	IEEE 802.11a/b/g/n/ac
Signal Rate	Up to 574Mbps at 2.4GHz Up to 1201Mbps at 5GHz	Up to 300 Mbps at 2.4GHz Up to 867 Mbps at 5GHz	Up to 574Mbps at 2.4GHz Up to 1201Mbps at 5GHz	Up to 300 Mbps at 2.4GHz Up to 867 Mbps at 5GHz
Interface	(3)10/100/1000M Base-T LAN Ethernet ports (1)10/100/1000M Base-T WAN Ethernet port	(1) 10/100/1000M Base-T Ethernet port	(3)10/100/1000M Base-T LAN Ethernet ports	(1)10/100/1000M Base-T WAN Ethernet port (2)10/100/1000M Base-T LAN Ethernet ports
Power Supply	DC 12V 1A	802.3af/at PoE Supported	802.3bt PoE Supported	Hi-PoE Supported

Passive Optical LAN Solution



Upgrade to intelligent, simplified, ultra-broadband next-generation all-optical POL networks for Wi-Fi 7 wireless networks. Wi-Tek POL solutions combine the advantages of light weight, small size, large bandwidth, long distance, long service life and passive transmission of optical fibers in optical networks with the centralized and visual management of traditional networks on the cloud. With fewer faulty nodes, easier fault location, and more efficient operation and maintenance, greatly reducing operation and maintenance costs.



Optical Networking



Cloud Management



Flexible Deployment



Easy Topology



Passive Aggregation Layer



Ultra-Broadband

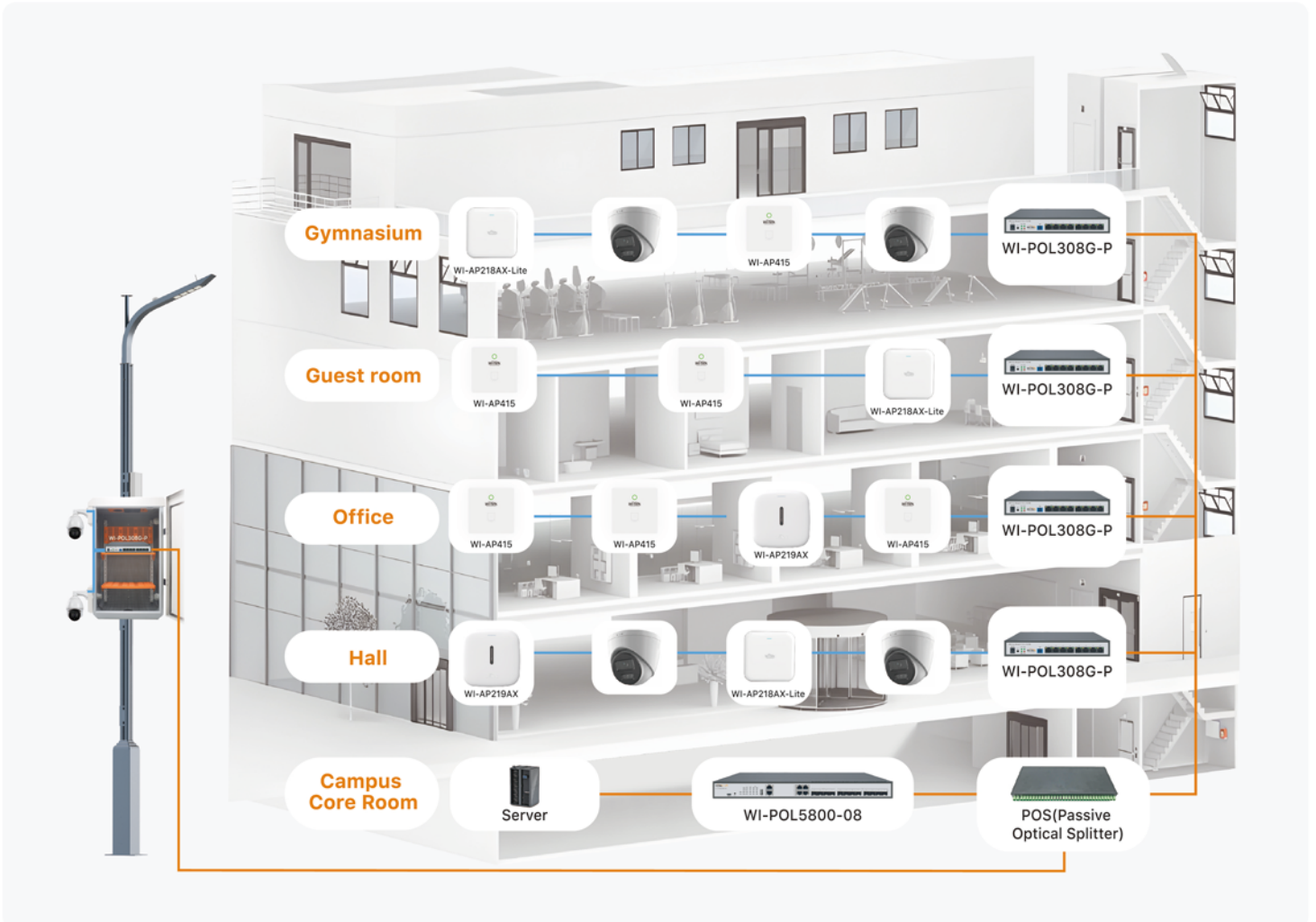

Passive Optical LAN Solution



● xPON Cloud Managed 8 Ports PoE MDU (WI-POL308G-P)

- For next generation all-optical networks
- 1*PON SC/UPC, 8*1000Mbps PoE+ RJ45
- 1.25G uplink/2.5G downlink GPON mode
- IEEE 802.3af/at, total PoE power budget 110W max
- Comply with ONVIF protocol
- Wi-Tek cloud, OMCI, OAM, WEB management



● Cloud Managed GPON OLT (WI-POL5800-08)

- For next generation all-optical networks
- 4*1000Mbps RJ45, 4*10G SFP+, 8*GPON
- 1:128 Max splitting ratio
- Standard OMCI, comply with other brand's MDU
- Up to 20km GPON physical transmission distance
- L2 features: ACL, QoS, VLAN, STP Safety
- L3 features: IP router, RIP/OSPF/ISIS/BGP/VRRP
- Wi-Tek cloud management, MDU & ONU centralized management

IP68 Industrial PoE Extender/Injector/Splitter



Wi-Tek Industrial Accessories PoE Extenders, PoE Injectors, PoE Splitters provide a simple, efficient and reliable solution for industrial-grade scenarios. Add more PoE ports without cabling, allowing flexible network deployment. Waterproof housing, small size, high power output, flexible deployment is a good choice for CCTV projects.

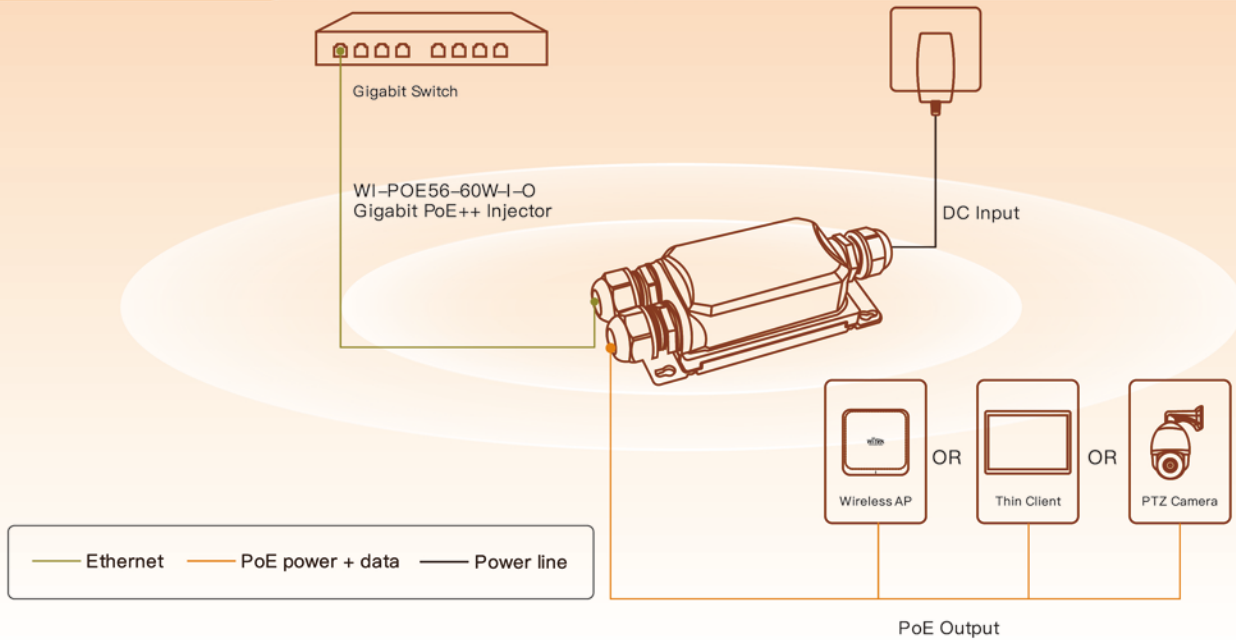

Up to 802.3bt PoE++



IP68 Waterproof Enclosure



Plug and Play



Model	WI-POE21E-O	WI-POE22E-O	WI-POE56-60W-I-O	WI-POE56S-BT-I-O
Product	PoE Extender	POE Extender	PoE Injector	PoE Splitter
Interface	PoE input port: 1*1000Mbps Po port with 802.3bt 60W PoE output port: 2*1000Mbps PoE port with 802.3af/at 30W	PoE input port: 1*1000Mbps PoE port with 802.3bt 90W PoE output port: 1*1000Mbps PoE port with 802.3af/at 30W 1*1000Mbps PoE port with 802.3af/at 60W	Data input port: 1x1000Mbps Ethernet port Power input port: DC 24-56V/3A Max PoE output port: 1*1000Mbps PoE port with 802.3bt 60W	PoE input port: 1x1000Mbps PoE port with 802.3bt 95W Data output port: 1x1000Mbps Ethernet port DC output port: 12V/5A Max
Waterproof	1P68	1P68	1P68	1P68

PoE Injector/ PoE Splitter



Wi-Tek PoE Injectors and PoE Splitters provide different power and high-speed Ethernet data connections anywhere in your network infrastructure. Your IP camera and wireless AP will not be limited by the locations without a power outlet and no additional AC wiring. Most of all, it reduces installation time.

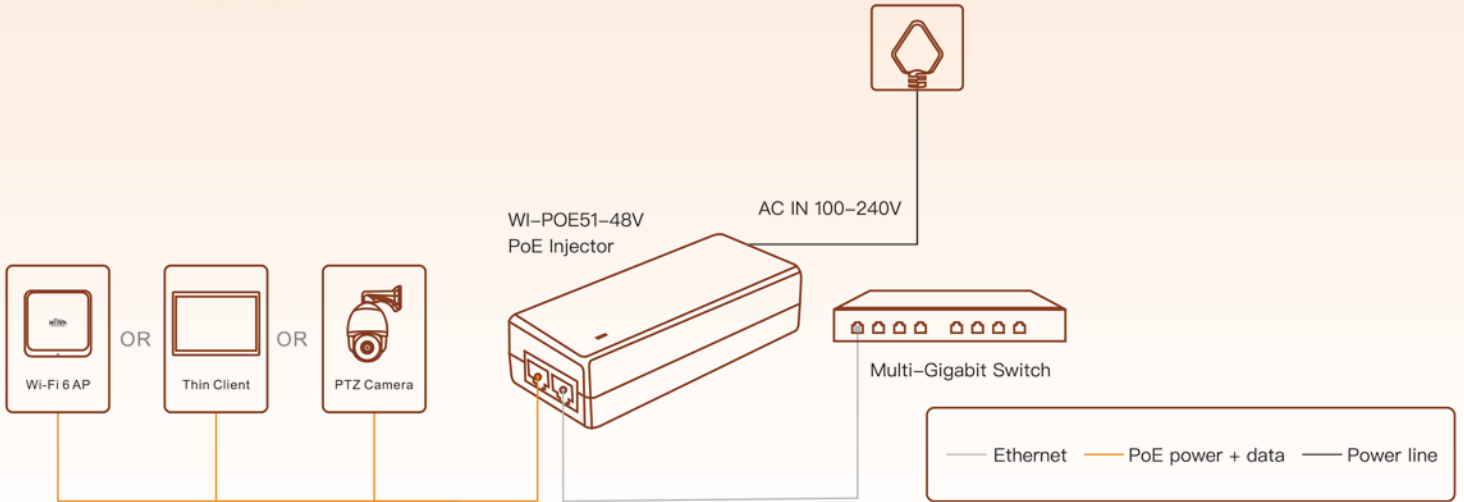

Convert non-PoE to PoE



Support desktop/wall-mount







Plug and play installation

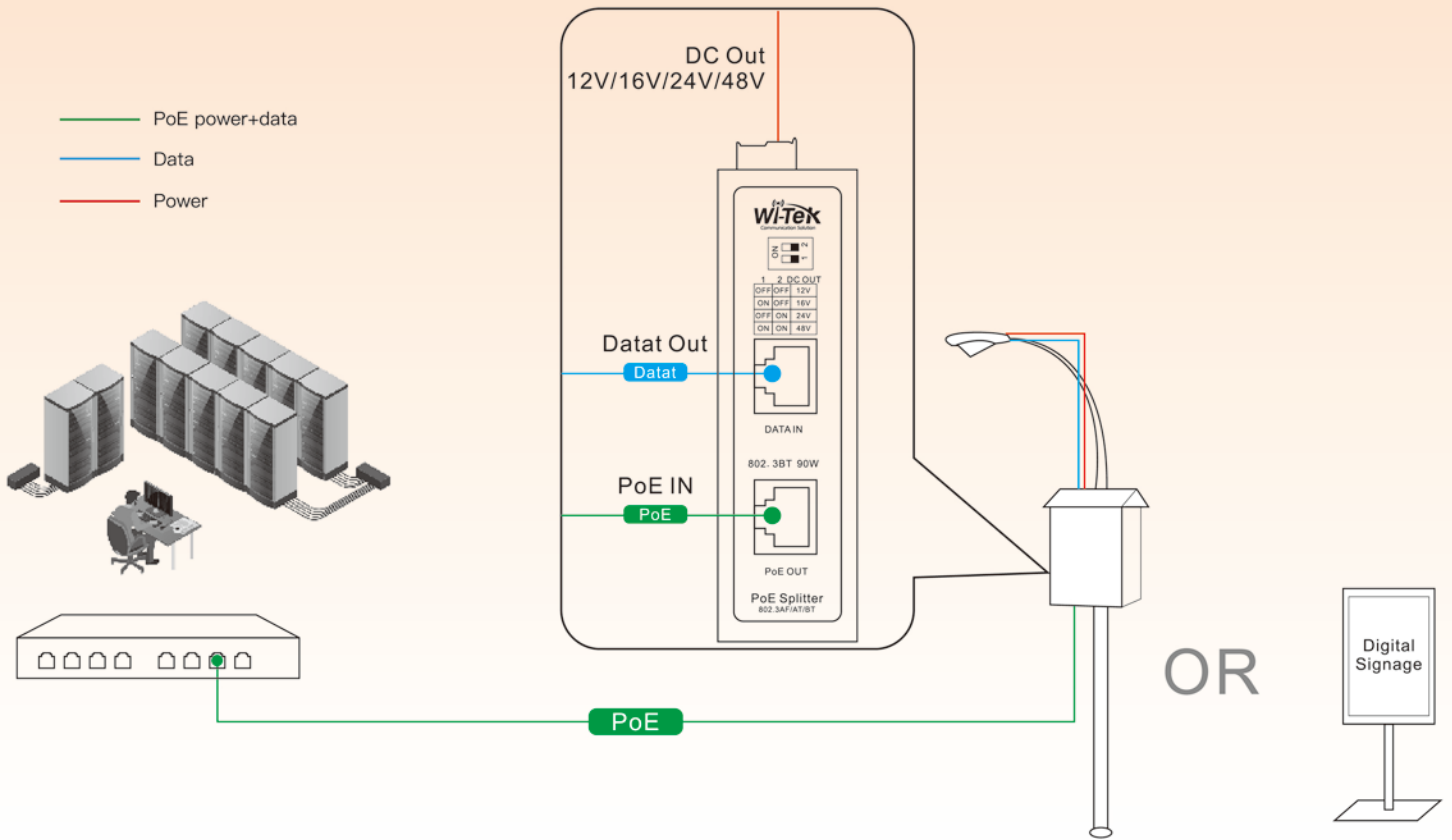

Model	WI-POE31-48V	WI-POE51-48V	WI-POE31-24V	WI-POE51-24V
Interface	1*10/100Mbps PoE RJ45 Port 1*10/100Mbps Ethernet Port	1*100/1000Mbps PoE RJ45 Port 1*100/1000Mbps Ethernet Port	1*10/100Mbps PoE RJ45 Port 1*10/100Mbps Ethernet Port	1*100/1000Mbps PoE RJ45 Port 1*100/1000Mbps Ethernet Port
Power Supply	AC IN 100-240V	AC IN 100-240V	AC IN 100-240V	AC IN 100-240V
Data In/Out	1*10/100Mbps Data In	1*10/1000Mbps Data In	1*10/100Mbps Data In	1*10/1000Mbps Data In
Power In/Out Port	1*802.3af/at PoE Out	1*802.3af/at PoE Out	1*24V Passive PoE Out	1*24V Passive PoE Out
PoE Consumption	30W	30W	24W	24W
Working Temperature	-10°C~55°C	-10°C~55°C	-10°C~55°C	-10°C~55°C

PoE Injector/PoE Splitter



				
Model	WI-POE55-48V-60W	WI-POE58-BT-I-DC	WI-POE55S-BT-I-DC	WI-POE11S-48V
Interface	1*100/1000Mbps PoE RJ45 Port 1*100/1000Mbps Ethernet Port	1*100/1000Mbps PoE RJ45 Port 1*100/1000Mbps Ethernet Port	1*100/1000Mbps PoE RJ45 Port 1*100/1000Mbps Ethernet Port	1*10/100Mbps PoE RJ45 Port 1*10/100Mbps Ethernet Port
Power Supply	AC IN 100-240V	DC IN 12-57V	48-55V PoE IN	48V PoE IN
Data In/Out	1*100/1000Mbps Data In	1*100/1000Mbps Data In	1*100/1000Mbps Data Out	1*10/1000Mbps Data Out
Power In/Out Port	1*802.3 af/at/bt 60W PoE Out	1*802.3 af/at/bt 90W PoE Out	12V/16V/24V/48V DC Out	12V DC Out
Working Temperature	-10°C~55°C	-40°C~75°C	-40°C~75°C	-10°C~55°C

PoE Extender



Wi-Tek PoE Extender can extend both the Ethernet Data and power over Ethernet transmission distance over 100m. Wi-Tek PoE Extender extends an PoE+/PoE++ network connection an additional 100m with 100Mbps from the PoE power source equipment. DIP switch provides Extend mode(250m Long range), and VLAN mode. No configuration is needed, quick provision and more flexible project adaptation.



Model	WI-PE31E	WI-PE31G	WI-PE51E	WI-PE51G
Interface	PoE input port: 1*100Mbps PoE port with 802.3af/at 30W PoE output port: 2*100Mbps PoE port with 802.3af/at 30W	PoE input port: 1*1000Mbps PoE port with 802.3af/at 30W PoE output port: 2*1000Mbps PoE port with 802.3af/at 30W	PoE input port: 1*100Mbps PoE port with 802.3bt 60W PoE output port: 4*100Mbps PoE port with 802.3af/at 30W 1*100Mbps PoE port	PoE input port: 1*1000Mbps PoE port with 802.3bt 90W PoE output port: 4*100Mbps PoE port with 802.3af/at 30W



Extend your network up to 650m



Plug and play

➤ Fiber Optical Media Converter



- **Flexible Selections of Distance and Speed**

Provide different transmission distances of up to 25km. 100Mbps or 1000Mbps speed provide flexible speed options.

- **Innovative Combination of PoE and Fiber**

The PoE output provides simultaneous data and power connection to the IP camera, making remote camera deployment easier and more convenient.

- **Stable Network Transmission**

The stability of Fiber Optical Media Converter guarantees stable transmission and reliable network performance.

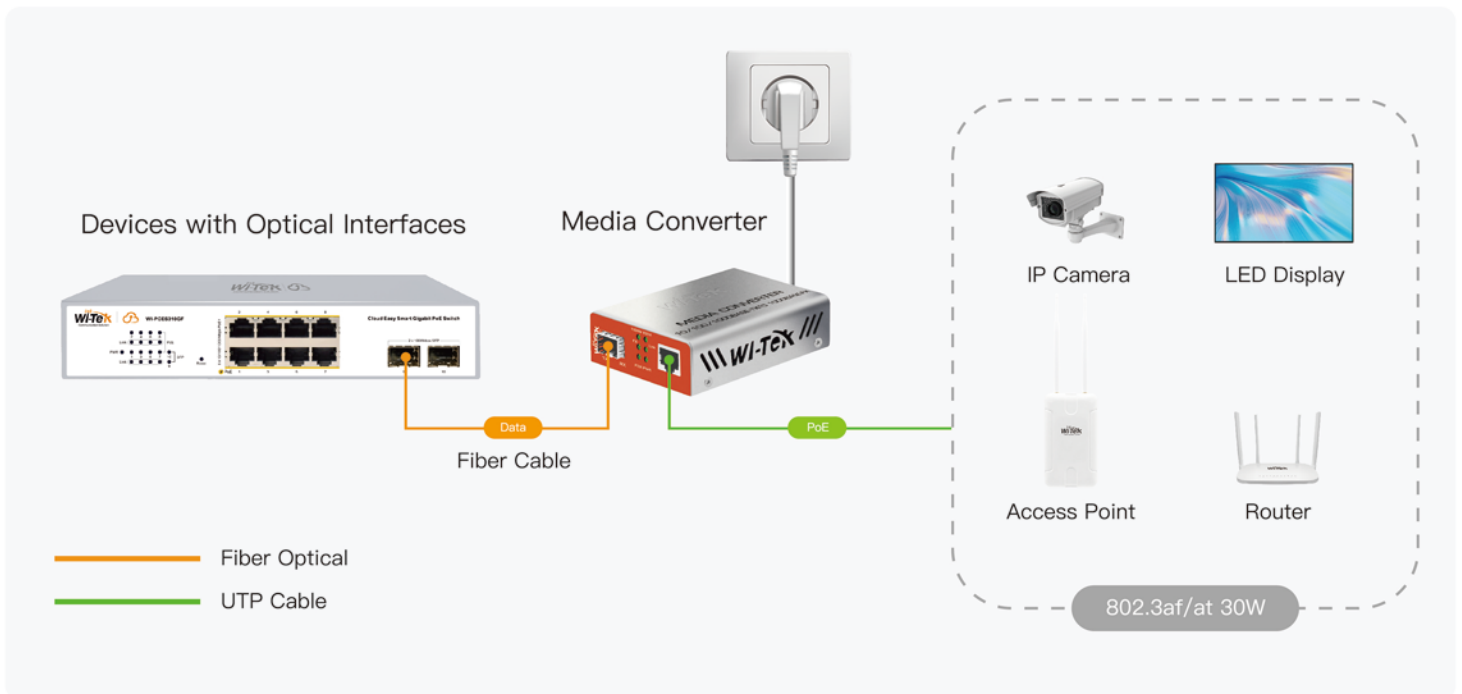

Model	WI-MC101M	WI-MC101G	WI-MC111GP
Speed	100Mbps	1000Mbps	1000Mbps
Transmit Range	25km	25km	Depend on the inserting SFP
Ports	1FE +1SC	1GE +1SC	1GE(PoE) +1SFP Slot
PoE Output	N/A	N/A	802.3af/at
Power Adapter	5V/1A (included)	5V/1A (included)	52V/0.92A (included)
Fiber Type	Single Mode	Single Mode	SFP Slot





Technical Support



Cloud Management



Company Website



Wi-Tek Cloud Q

Available on the App Store

Google play

Wireless-Tek Technology Limited

Address: Building 3, Units 1801-1807, 1812, Huaqiang Era Plaza, Tangwei Community, Fuhai Street, Bao'an District, Shenzhen City, Guangdong Province, China.

Website: www.wireless-tek.com

Tel: 86-0755-32811290

Email: sales@wireless-tek.com

Technical Support: tech@wireless-tek.com

Follow us on Social Media



YouTube



LinkedIn



Face book



Instagram



Twitter