

HIKVISION



Thermal Network Bullet Camera

User Manual

COPYRIGHT © 2018 Hikvision. ALL RIGHTS RESERVED

User Manual

COPYRIGHT ©2018 Hangzhou Hikvision Digital Technology Co., Ltd.

ALL RIGHTS RESERVED.

Any and all information, including, among others, wordings, pictures, graphs are the properties of Hangzhou Hikvision Digital Technology Co., Ltd. or its subsidiaries (hereinafter referred to be "Hikvision"). This user manual (hereinafter referred to be "the Manual") cannot be reproduced, changed, translated, or distributed, partially or wholly, by any means, without the prior written permission of Hikvision. Unless otherwise stipulated, Hikvision does not make any warranties, guarantees or representations, express or implied, regarding to the Manual.

About this Manual

This Manual is applicable to **Thermal Network Bullet Camera**.

The Manual includes instructions for using and managing the product. Pictures, charts, images and all other information hereinafter are for description and explanation only. The information contained in the Manual is subject to change, without notice, due to firmware updates or other reasons.

Please find the latest version in the company website (<http://overseas.hikvision.com/en/>).

Please use this user manual under the guidance of professionals.

Trademarks Acknowledgement

HIKVISION and other Hikvision's trademarks and logos are the properties

of Hikvision in various jurisdictions. Other trademarks and logos mentioned below are the properties of their respective owners.

Legal Disclaimer

TO THE MAXIMUM EXTENT PERMITTED BY APPLICABLE LAW, THE PRODUCT DESCRIBED, WITH ITS HARDWARE, SOFTWARE AND FIRMWARE, IS PROVIDED "AS IS", WITH ALL FAULTS AND ERRORS, AND HIKVISION MAKES NO WARRANTIES, EXPRESS OR IMPLIED, INCLUDING WITHOUT LIMITATION, MERCHANTABILITY, SATISFACTORY QUALITY, FITNESS FOR A PARTICULAR PURPOSE, AND NON-INFRINGEMENT OF THIRD PARTY. IN NO EVENT WILL HIKVISION, ITS DIRECTORS, OFFICERS, EMPLOYEES, OR AGENTS BE LIABLE TO YOU FOR ANY SPECIAL, CONSEQUENTIAL, INCIDENTAL, OR INDIRECT DAMAGES, INCLUDING, AMONG OTHERS, DAMAGES FOR LOSS OF BUSINESS PROFITS, BUSINESS INTERRUPTION, OR LOSS OF DATA OR DOCUMENTATION, IN CONNECTION WITH THE USE OF THIS PRODUCT, EVEN IF HIKVISION HAS BEEN ADVISED OF THE POSSIBILITY OF SUCH DAMAGES.

REGARDING TO THE PRODUCT WITH INTERNET ACCESS, THE USE OF PRODUCT SHALL BE WHOLLY AT YOUR OWN RISKS. HIKVISION SHALL NOT TAKE ANY RESPONSIBILITIES FOR ABNORMAL OPERATION, PRIVACY LEAKAGE OR OTHER DAMAGES RESULTING FROM CYBER ATTACK, HACKER ATTACK, VIRUS INSPECTION, OR OTHER INTERNET SECURITY RISKS; HOWEVER, HIKVISION WILL PROVIDE TIMELY TECHNICAL SUPPORT IF

REQUIRED.

SURVEILLANCE LAWS VARY BY JURISDICTION. PLEASE CHECK ALL RELEVANT LAWS IN YOUR JURISDICTION BEFORE USING THIS PRODUCT IN ORDER TO ENSURE THAT YOUR USE CONFORMS THE APPLICABLE LAW. HIKVISION SHALL NOT BE LIABLE IN THE EVENT THAT THIS PRODUCT IS USED WITH ILLEGITIMATE PURPOSES.

IN THE EVENT OF ANY CONFLICTS BETWEEN THIS MANUAL AND THE APPLICABLE LAW, THE LATER PREVAILS.

Regulatory Information

FCC Information

FCC compliance: This equipment has been tested and found to comply with the limits for a digital device, pursuant to part 15 of the FCC Rules. These limits are designed to provide reasonable protection against harmful interference when the equipment is operated in a commercial environment. This equipment generates, uses, and can radiate radio frequency energy and, if not installed and used in accordance with the instruction manual, may cause harmful interference to radio communications. Operation of this equipment in a residential area is likely to cause harmful interference in which case the user will be required to correct the interference at his own expense.

FCC Conditions

This device complies with part 15 of the FCC Rules. Operation is subject to the following two conditions:

1. This device may not cause harmful interference.
2. This device must accept any interference received, including interference that may cause undesired operation.

EU Conformity Statement



This product and - if applicable - the supplied accessories too are marked with "CE" and comply therefore with the applicable harmonized European standards listed under the EMC Directive 2004/108/EC, the RoHS Directive 2011/65/EU.



2012/19/EU (WEEE directive): Products marked with this symbol cannot be disposed of as unsorted municipal waste in the European Union. For proper recycling, return this product to your local supplier upon the purchase of equivalent new equipment, or dispose of it at designated collection points. For more information see: www.recyclethis.info.



2006/66/EC (battery directive): This product contains a battery that cannot be disposed of as unsorted municipal waste in the European Union. See the product documentation for specific battery information. The battery is marked with this symbol, which may include lettering to indicate cadmium (Cd), lead (Pb), or mercury (Hg). For proper recycling, return the battery to your supplier or to a designated collection point. For more information see: www.recyclethis.info.

Industry Canada ICES-003 Compliance

This device meets the CAN ICES-3 (A)/NMB-3(A) standards requirements.



Safety Instruction

These instructions are intended to ensure that the user can use the product correctly to avoid danger or property loss.

The precaution measure is divided into 'Warnings' and 'Cautions':

Warnings: Serious injury or death may be caused if any of these warnings are neglected.

Cautions: Injury or equipment damage may be caused if any of these cautions are neglected.

	
Warnings Follow these safeguards to prevent serious injury or death.	Cautions Follow these precautions to prevent potential injury or material damage.



Warnings:

Please adopt the power adapter which can meet the safety extra low voltage (SELV) standard. And source with 12 VDC or 24 VAC (depending on models) according to the IEC60950-1 and Limited Power Source standard.

To reduce the risk of fire or electrical shock, do not expose this product to rain or moisture.

This installation should be made by a qualified service person and should

conform to all the local codes.

Please install blackouts equipment into the power supply circuit for convenient supply interruption.

Please make sure that the ceiling can support more than 50(N) Newton gravities if the camera is fixed to the ceiling.

If the product does not work properly, please contact your dealer or the nearest service center. Never attempt to disassemble the camera yourself.

(We shall not assume any responsibility for problems caused by unauthorized repair or maintenance.)



Cautions:

Make sure the power supply voltage is correct before using the camera.

Do not drop the camera or subject it to physical shock.

Do not touch sensor modules with fingers. If cleaning is necessary, use a clean cloth with a bit of ethanol and wipe it gently. If the camera will not be used for an extended period of time, put on the lens cap to protect the sensor from dirt.

Do not aim the camera lens at the strong light such as sun or incandescent lamp. The strong light can cause fatal damage to the camera.

The sensor may be burned out by a laser beam, so when any laser equipment is being used, make sure that the surface of the sensor not be

exposed to the laser beam.

Do not place the camera in extremely hot, cold temperatures (the operating temperature should be between -30°C to +60°C, or -40°C to +60°C if the camera model has an "H" in its suffix), dusty or damp environment, and do not expose it to high electromagnetic radiation.

To avoid heat accumulation, ensure there is good ventilation to the device.

Keep the camera away from water and any liquids.

While shipping, pack the camera in its original, or equivalent, packing materials. Or packing the same texture.

Improper use or replacement of the battery may result in hazard of explosion. Please use the manufacturer recommended battery type.

Notes:

For the camera supports IR, you are required to pay attention to the following precautions to prevent IR reflection:

Dust or grease on the dome cover will cause IR reflection. Please do not remove the dome cover film until the installation is finished. If there is dust or grease on the dome cover, clean the dome cover with clean soft cloth and isopropyl alcohol.

Make certain the installation location does not have reflective surfaces of objects too close to the camera. The IR light from the camera may reflect back into the lens causing reflection.

The foam ring around the lens must be seated flush against the inner

surface of the bubble to isolate the lens from the IR LEDs. Fasten the dome cover to camera body so that the foam ring and the dome cover are attached seamlessly.

Table of Contents

Chapter 1	Overview	1
1.1	Overview.....	1
1.2	System Requirement.....	1
1.3	Main Functions	2
Chapter 2	Network Connection.....	4
2.1	Setting the Network Camera over the LAN	4
2.1.1	Wiring over the LAN	5
2.1.2	Activating the Camera	5
2.2	Setting the Network Camera over the WAN.....	13
2.2.1	Static IP Connection.....	13
2.2.2	Dynamic IP Connection	15
Chapter 3	Access to the Network Camera	19
3.1	Accessing by Web Browsers.....	19
3.2	Accessing by Client Software.....	20
Chapter 4	Live View.....	23
4.1	Live View Page	23
4.2	Starting Live View	24
4.3	Recording and Capturing Pictures Manually.....	25
4.4	Operating PTZ Control	25
4.4.1	PTZ Control Panel	26
4.4.2	Setting/Calling a Preset	27
4.4.3	Setting/Calling a Patrol	29
Chapter 5	Network Camera Configuration	31
5.1	Configuring Local Parameters	31
5.2	Configure System Settings.....	34
5.2.1	Configuring Basic Information.....	34
5.2.2	Configuring Time Settings.....	36
5.2.3	Configuring RS232 Settings.....	38
5.2.4	Configuring DST Settings	39
5.2.5	Viewing License	40

5.3	Maintenance.....	40
5.3.1	Upgrade & Maintenance	40
5.3.2	Log	42
5.3.3	System Service	43
5.3.4	VCA Resource Type.....	44
5.4	Security Settings.....	45
5.4.1	Authentication	45
5.4.2	IP Address Filter	46
5.4.3	Security Service	48
5.5	User Management.....	49
5.5.1	User Management.....	49
Chapter 6 Network Settings.....		54
6.1	Configuring Basic Settings.....	54
6.1.1	Configuring TCP/IP Settings.....	54
6.1.2	Configuring DDNS Settings	56
6.1.3	Configuring PPPoE Settings.....	58
6.1.4	Configuring Port Settings	59
6.1.5	Configure NAT (Network Address Translation) Settings.....	60
6.2	Configure Advanced Settings.....	62
6.2.1	Configuring SNMP Settings	62
6.2.2	Configuring FTP Settings	65
6.2.3	Configuring Email Settings.....	67
6.2.4	Configuring HTTPS Settings.....	70
6.2.5	Configuring QoS Settings	72
6.2.6	Configuring 802.1X Settings	73
Chapter 7 Video/Audio Settings.....		76
7.1	Configuring Video Settings.....	76
7.2	Configuring Audio Settings.....	81
7.3	Configuring ROI Encoding	82
7.4	metadata Settings	84
Chapter 8 Image Settings		86
8.1	Configuring Display Settings.....	86
8.2	Configuring OSD Settings.....	90
8.3	Configuring Privacy Mask.....	92
8.4	Configuring Picture Overlay.....	93

8.5	Configuring DPC (Defective Pixel Correction)	94
8.6	Configuring VCA Rule Display	95
Chapter 9 Event Settings.....		97
9.1	Basic Events	97
9.1.1	Configuring Motion Detection.....	97
9.1.2	Configuring Video Tampering Alarm.....	105
9.1.3	Configuring Alarm Input	107
9.1.4	Configuring Alarm Output	109
9.1.5	Handling Exception	110
9.2	Smart Events.....	111
9.2.1	Configuring Audio Exception Detection	111
9.2.2	Configuring Scene Change Detection	113
9.2.3	Configuring Dynamic Fire Source Detection	114
9.2.4	Configuring Fire Source Detection Shield.....	116
9.3	VCA Configuration	118
9.3.1	Configuring Overlay & Capture.....	118
9.3.2	Behavior Analysis Configuration.....	120
9.3.3	Configuring Shield Region	123
9.3.4	Configuring Rule	124
9.3.5	Advanced Configuration	126
9.4	Temperature Measurement	129
9.4.1	Basic Settings	129
9.4.2	Configuring Temperature Measurement Rule	131
9.4.3	Linkage Method	138
Chapter 10 Storage Settings.....		140
10.1	Configuring Record Schedule.....	140
10.2	Configure Capture Schedule	144
10.3	Configuring Net HDD	146
10.4	Memory Card Detection.....	149
10.5	Configuring Lite Storage	152
Chapter 11 Open Platform setting		154
Chapter 12 Playback.....		156
Chapter 13 Picture.....		159

Appendix..... **161**

Appendix 1 SADP Software Introduction..... **161**

Appendix 2 Port Mapping **164**

Chapter 1 Overview

1.1 Overview

Thermal Network Bullet Camera is applied to perimeter defense and fire-prevention purposes in critical infrastructures such as: airport, railway, prison, power station, 4S stores, and so on. The pre-alarm system helps you discover unexpected events immediately and protects you from property loss.

You can get a high-quality live view via web browser or client software.

The figure below shows the thermal network bullet camera series.

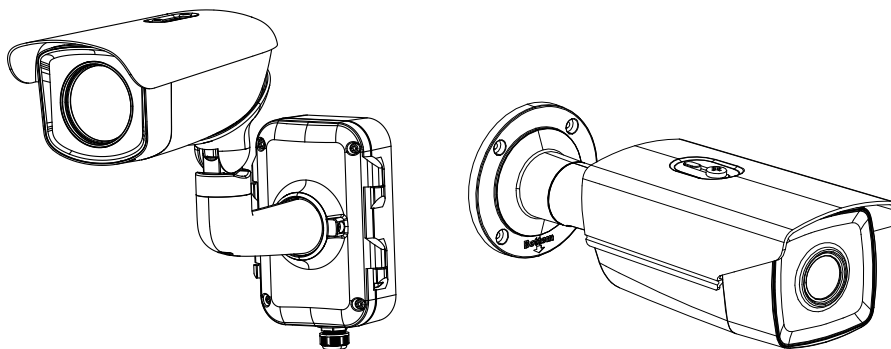

Figure 1-1 Bullet Camera Overview

1.2 System Requirement

Operating System: Microsoft Windows XP SP1 and above version

CPU: 2.0 GHz or higher

RAM: 1G or higher

Display: 1024×768 resolution or higher

Web Browser: Internet Explorer 8.0 and above version, Apple Safari 5.0.2 and above version, Mozilla Firefox 5.0 and above version and Google Chrome 18 and above version.

1.3 Main Functions

The main functions of this camera is fire source detection, and temperature measurement, and VCA (video content analysis) functions.

- **Fire Detection**
Fire Source Detection Shield enables you to shield certain areas from being detected in fire source detection.
For fire detection, refer to **Section 9.2.3 Configuring Dynamic Fire Source Detection**.
- **Temperature Measurement**
When you enable this function, it measures the actual temperature of the spot being monitored. The device alarms when temperature exceeds the temperature threshold value.
For temperature measurement, refer to **Section 9.4 Temperature Measurement**.
- **VCA function**
You can do intelligent analysis, such as behavior analysis. Multiple rules can be configured for different requirements.
For VCA function, refer to **9.3 VCA Configuration**.
- **Alarm Input and Output**
Refer to the figure below to configure the alarm devices and sensors.

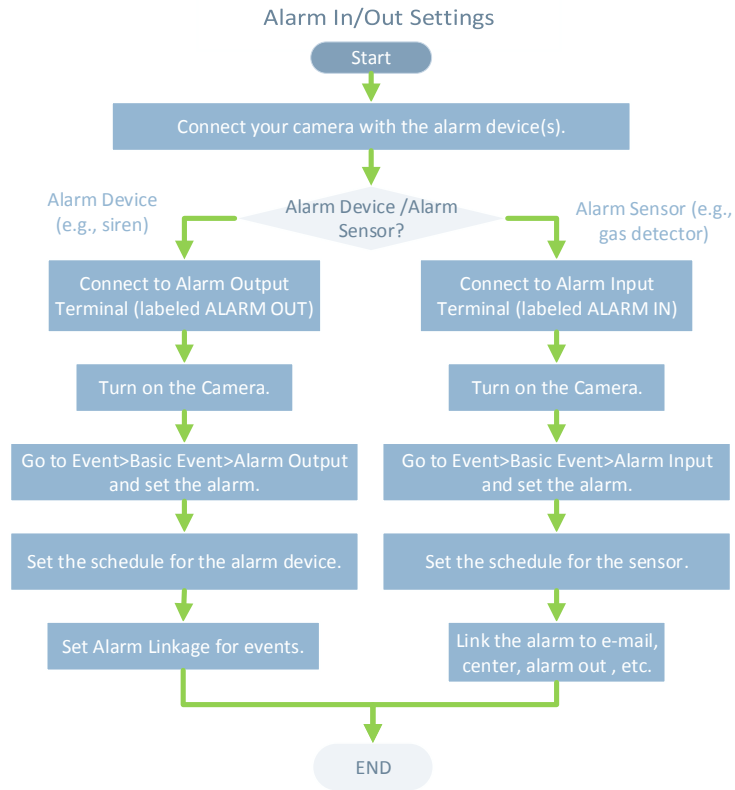

Chapter 2 Network Connection

Note:

You shall acknowledge that the use of the product with Internet access might be under network security risks. For avoidance of any network attacks and information leakage, please strengthen your own protection. If the product does not work properly, please contact with your dealer or the nearest service center.

To ensure the network security of the network camera, we recommend you to have the network camera assessed and maintained termly. You can contact us if you need such service.

Before you start:

If you want to set the network camera via a LAN (Local Area Network), please refer to 2.1.

If you want to set the network camera via a WAN (Wide Area Network), please refer to 2.2.

2.1 Setting the Network Camera over the LAN

Purpose:

To view and configure the camera via a LAN, you need to connect the network camera in the same subnet with your computer, and install the SADP or iVMS-4200 software to search and change the IP of the network camera.

Note: For the detailed introduction of SADP, please refer to Appendix 1.

2.1.1 Wiring over the LAN

The following figures show the two ways of cable connection of a network camera and a computer:

Purpose:

To test the network camera, you can directly connect the network camera to the computer with a network cable as shown in Figure 2-1.

Refer to Figure 2-2 to set network camera over the LAN via a switch or a router.

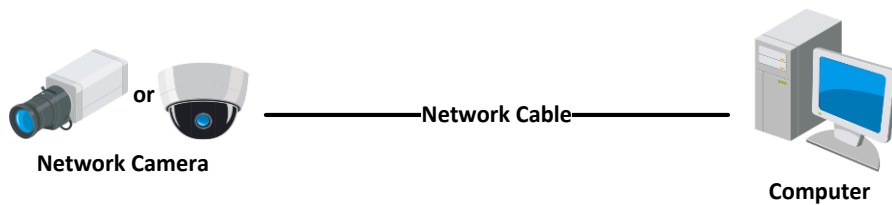

Figure 2-1 Connecting Directly

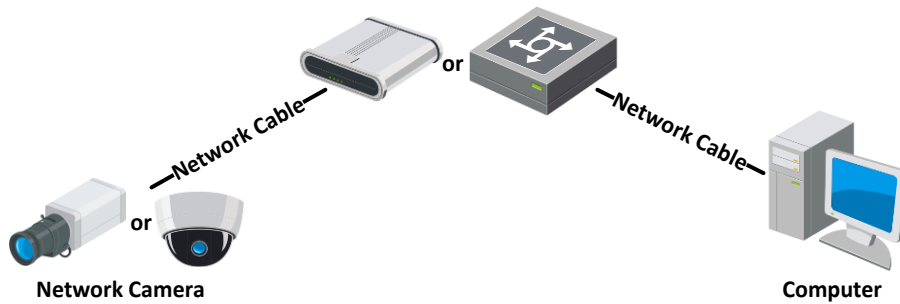

Figure 2-2 Connecting via a Switch or a Router

2.1.2 Activating the Camera

You are required to activate the camera first by setting a strong password for it before you can use the camera.

Activation via Web Browser, Activation via SADP, and Activation via Client

Software are all supported.

Activation via Web Browser

Steps:

1. Power on the camera, and connect the camera to the network.
2. Input the IP address into the address bar of the web browser, and click **Enter** to enter the activation interface.

Notes:

The default IP address of the camera is 192.168.1.64.

The computer and the camera should belong to the same subnet.

For the camera enables the DHCP by default, you need to use the SADP software to search the IP address.

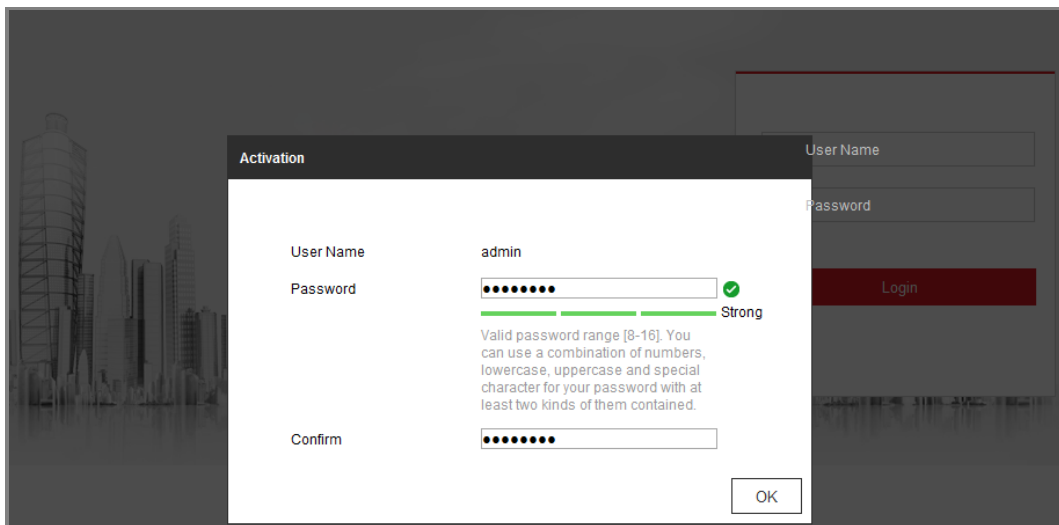

Figure 2-3 Activation via Web Browser

3. Create a password and input the password into the password field.



STRONG PASSWORD RECOMMENDED—We highly recommend you create a strong password of your own choosing (using a minimum of 8 characters, including at least three of the following categories: upper case letters, lower case letters, numbers, and special characters) in order to increase the security of your product. And we recommend you reset your password regularly, especially in the high security system, resetting the password monthly or weekly can better protect your product.

4. Confirm the password.
5. Click **OK** to save the password and enter the live view interface.

Activation via SADP Software

SADP software is used for detecting the online device, activating the camera, and resetting the password.

Get the SADP software from the supplied disk or the official website, and install the SADP according to the prompts. Follow the steps to activate the camera.

Steps:

1. Run the SADP software to search the online devices.
2. Check the device status from the device list, and select the inactive device.

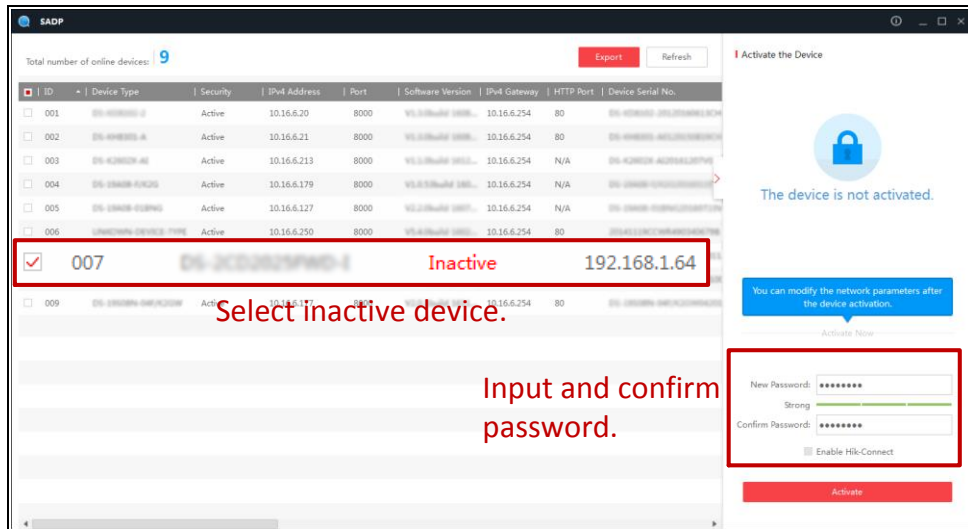



Figure 2-4 SADP Interface

Note:

The SADP software supports activating the camera in batch. Refer to the user manual of SADP software for details.

3. Create a password and input the password in the password field, and confirm the password.



STRONG PASSWORD RECOMMENDED—We highly recommend you create a strong password of your own choosing (using a minimum of 8 characters, including at least three of the following categories: upper case letters, lower case letters, numbers, and special characters) in order to increase the security of your product. And we recommend you reset your password regularly, especially in the high security system, resetting the password monthly or weekly can better protect your product.

Note:

You can enable the Hik-Connect service for the device during activation.

4. Click **Activate** to start activation.

You can check whether the activation is completed on the popup window. If activation failed, please make sure that the password meets the requirement and try again.

5. Change the device IP address to the same subnet with your computer by either modifying the IP address manually or checking the checkbox of Enable DHCP.

Modify Network Parameters

Enable DHCP
 Enable Hik-Connect

Device Serial No.: XX-XXXXXXXX-XXXXXXXXXXXXXXXX

IP Address: 192.168.1.64

Port: 8000

Subnet Mask: 255.255.255.0

Gateway: 192.168.1.1

IPv6 Address: ::

IPv6 Gateway: ::

IPv6 Prefix Length: 0

HTTP Port: 80

Security Verification

Admin Password:

Modify

[Forgot Password](#)

Figure 2-5 Modify the IP Address

6. Input the admin password and click **Modify** to activate your IP address modification.

The batch IP address modification is supported by the SADP. Refer to the user manual of SADP for details.

Activation via Client Software

The client software is versatile video management software for multiple kinds of devices.

Get the client software from the supplied disk or the official website, and install the software according to the prompts. Follow the steps to activate the camera.

Steps:

1. Run the client software and the control panel of the software pops up, as shown in the figure below.

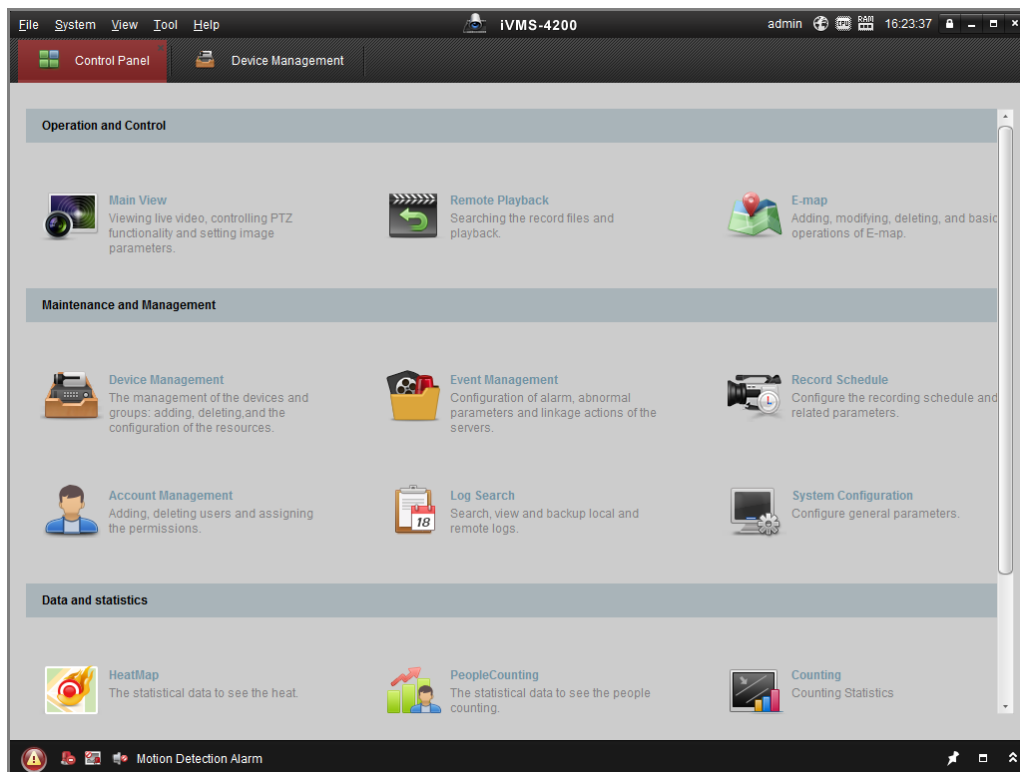

Figure 2-6 Control Panel

2. Click the **Device Management** icon to enter the Device Management interface, as shown in the figure below.

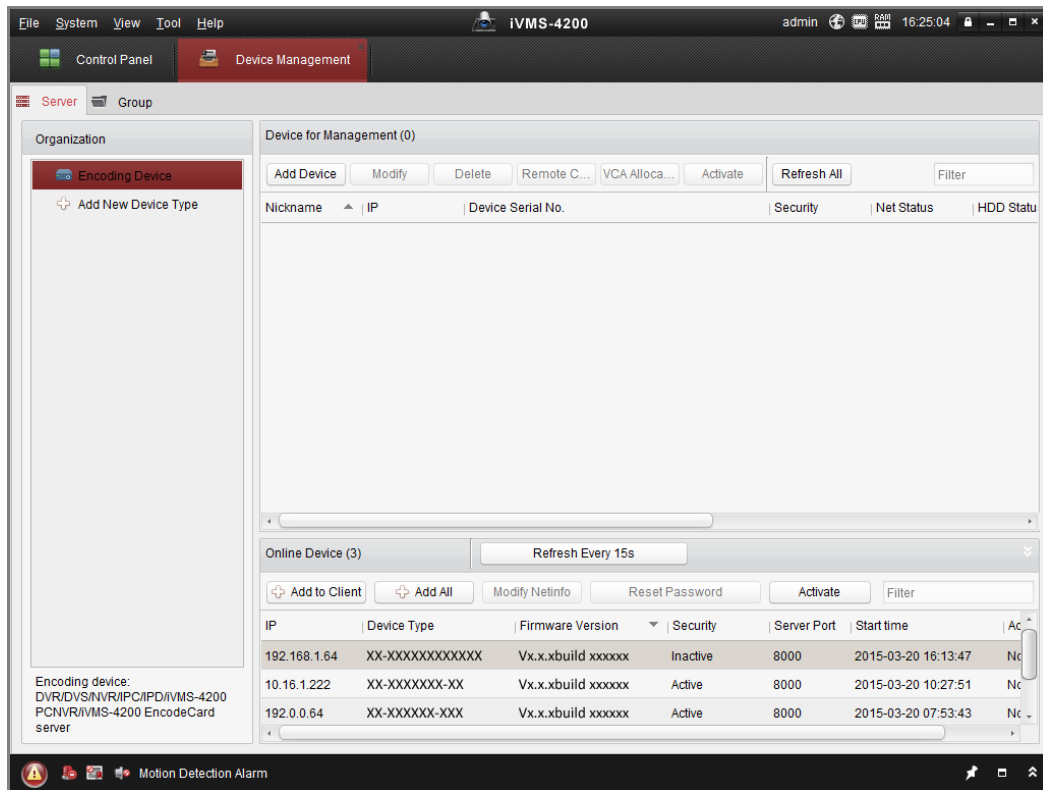

Figure 2-7 Device Management Interface

3. Check the device status from the device list, and select an inactive device.
4. Click the **Activate** button to pop up the Activation interface.
5. Create a password and input the password in the password field, and confirm the password.



STRONG PASSWORD RECOMMENDED—We highly recommend you create a strong password of your own choosing (using a minimum of 8 characters, including at least three of the following categories: upper case letters, lower case letters, numbers, and special characters) in order to increase the security of your product. And we recommend you reset your password regularly, especially in the high security system, resetting the password monthly or weekly can better protect your product.

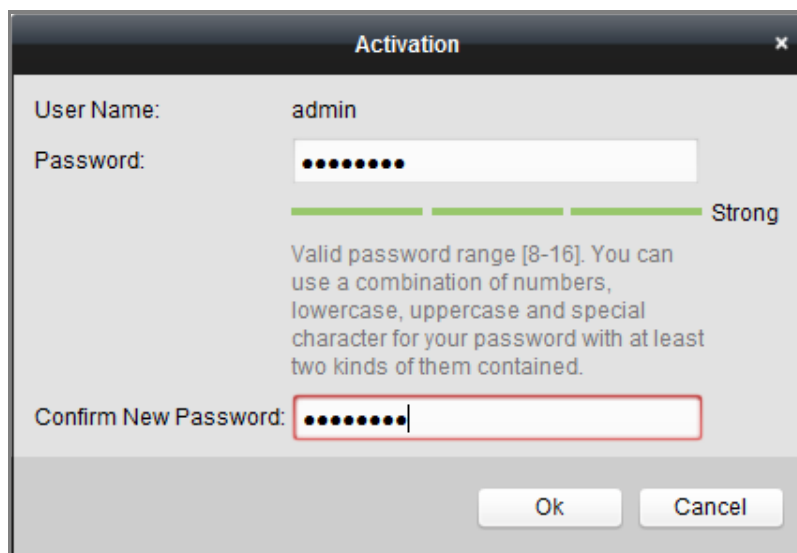

Figure 2-8 Activation Interface (Client Software)

6. Click **OK** button to start activation.
7. Click the Modify Netinfo button to pop up the Network Parameter Modification interface, as shown in the figure below.

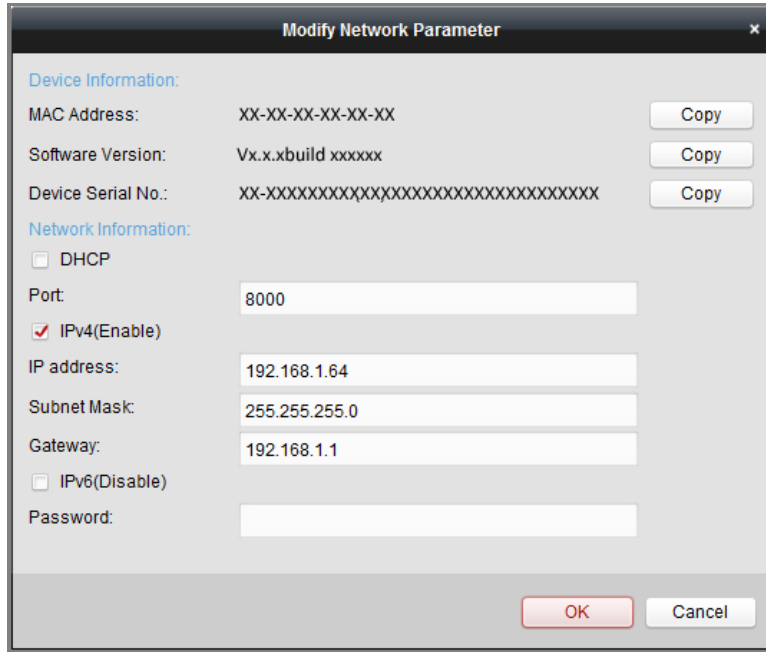

Figure 2-9 Modifying the Network Parameters

8. Change the device IP address to the same subnet with your computer by either modifying the IP address manually or checking the checkbox of Enable DHCP.
9. Input the password to activate your IP address modification.

2.2 Setting the Network Camera over the WAN

Purpose:

This section explains how to connect the network camera to the WAN with a static IP or a dynamic IP.

2.2.1 Static IP Connection

Before you start:

Please apply a static IP from an ISP (Internet Service Provider). With the static

IP address, you can connect the network camera via a router or connect it to the WAN directly.

Connecting the network camera via a router

Steps:

1. Connect the network camera to the router.
2. Assign a LAN IP address, the subnet mask and the gateway. Refer to 2.1.2 for detailed IP address configuration of the network camera.
3. Save the static IP in the router.
4. Set port mapping, e.g., 80, 8000, and 554 ports. The steps for port mapping vary according to the different routers. Please call the router manufacturer for assistance with port mapping.

Note: Refer to Appendix 2 for detailed information about port mapping.

5. Visit the network camera through a web browser or the client software over the internet.

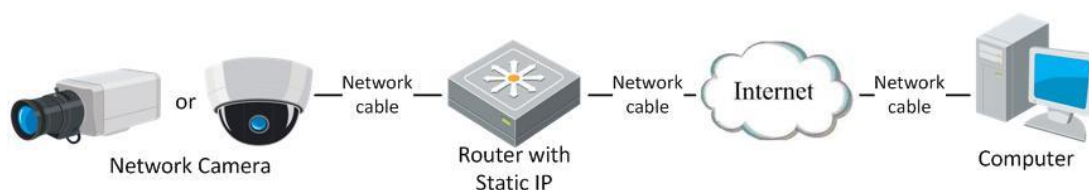

Figure 2-10 Accessing the Camera through Router with Static IP

Connecting the network camera with static IP directly

You can also save the static IP in the camera and directly connect it to the internet without using a router. Refer to 2.1.2 for detailed IP address configuration of the network camera.

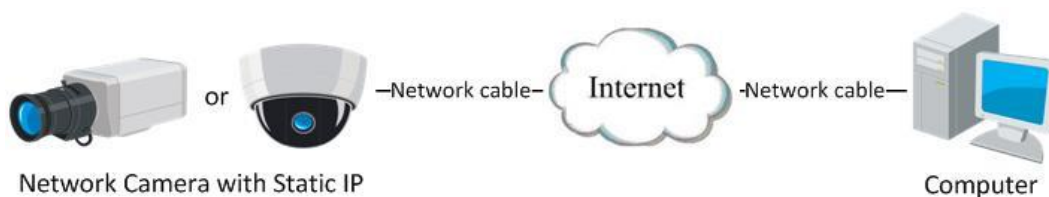

Figure 2-11 Accessing the Camera with Static IP Directly

2.2.2 Dynamic IP Connection

Before you start:

Please apply a dynamic IP from an ISP. With the dynamic IP address, you can connect the network camera to a modem or a router.

Connecting the network camera via a router

Steps:

1. Connect the network camera to the router.
2. In the camera, assign a LAN IP address, the subnet mask and the gateway.
Refer to Section 2.1.2 for detailed IP address configuration of the network camera.
3. In the router, set the PPPoE user name, password and confirm the password.
4. Set port mapping. E.g. 80, 8000, and 554 ports. The steps for port mapping vary depending on different routers. Please call the router manufacturer for assistance with port mapping.

Note: Refer to Appendix 2 for detailed information about port mapping.

5. Apply a domain name from a domain name provider.
6. Configure the DDNS settings in the setting interface of the router.

7. Visit the camera via the applied domain name.

Connecting the network camera via a modem

Purpose:

This camera supports the PPPoE auto dial-up function. The camera gets a public IP address by ADSL dial-up after the camera is connected to a modem. You need to configure the PPPoE parameters of the network camera. Refer to *Section 6.1.3 Configuring PPPoE Settings* for detailed configuration.

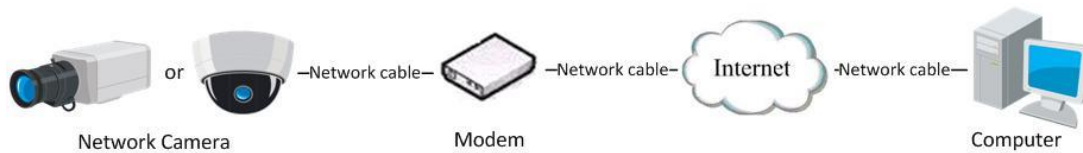

Figure 2-12 Accessing the Camera with Dynamic IP

Note: The obtained IP address is dynamically assigned via PPPoE, so the IP address always changes after rebooting the camera. To solve the inconvenience of the dynamic IP, you need to get a domain name from the DDNS provider (E.g. DynDns.com). Please follow the steps below for normal domain name resolution and private domain name resolution to solve the problem.

Normal Domain Name Resolution

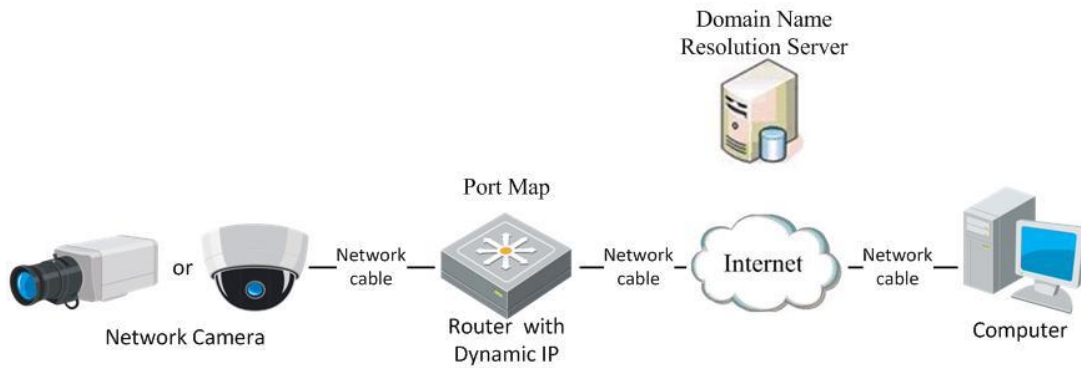

Figure 2-13 Normal Domain Name Resolution

Steps:

1. Apply a domain name from a domain name provider.
2. Configure the DDNS settings in the **DDNS Settings** interface of the network camera. Refer to *Section 6.1.2 Configuring DDNS Settings* for detailed configuration.
3. Visit the camera via the applied domain name.

Private Domain Name Resolution

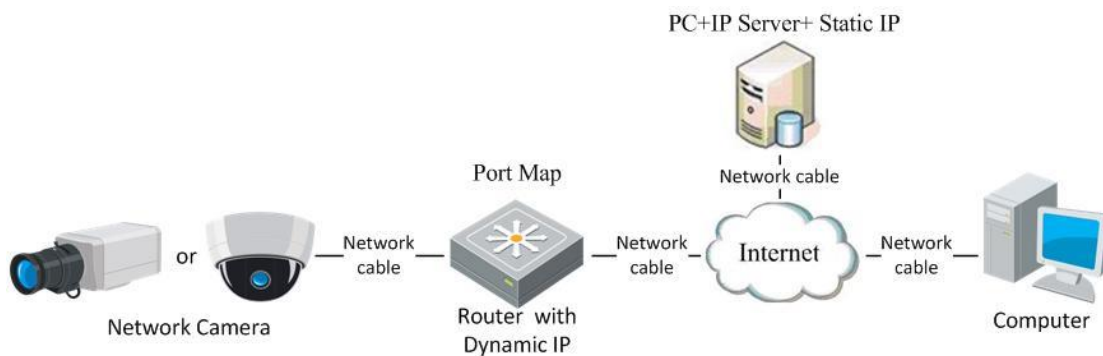

Figure 2-14 Private Domain Name Resolution

Steps:

1. Install and run the IP Server software in a computer with a static IP.
2. Access the network camera through the LAN with a web browser or the

client software.

3. Enable DDNS and select IP Server as the protocol type. Refer to *Section 6.1.2 Configuring DDNS Settings* for detailed configuration.

Chapter 3 Access to the Network Camera

3.1 Accessing by Web Browsers

Steps:

1. Open the web browser.
2. In the browser address bar, input the IP address of the network camera, and press the **Enter** key to enter the login interface.

Note:

The default IP address is 192.168.1.64. You are recommended to change the IP address to the same subnet with your computer.

3. Input the user name and password and click **Login**.

The admin user should configure the device accounts and user/operator permissions properly. Delete the unnecessary accounts and user/operator permissions.

Note:

The IP address gets locked if the admin user performs 7 failed password attempts (5 attempts for the user/operator).



Figure 3-1 Login Interface

4. Click **Login**.

5. Install the plug-in before viewing the live video and operating the camera.

Follow the installation prompts to install the plug-in.

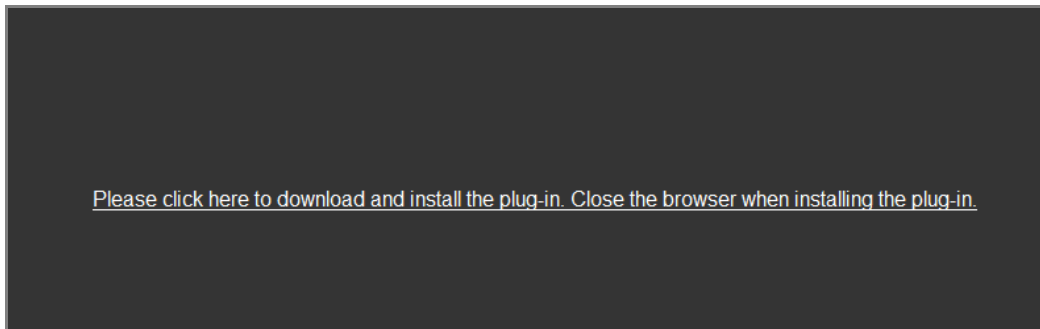

Figure 3-2 Download and Install Plug-in

Note: You may have to close the web browser to finish the installation of the plug-in.

6. Reopen the web browser after the installation of the plug-in and repeat steps 2 to 4 to login.

Note: For detailed instructions of further configuration, please refer to the user manual of network camera.

3.2 Accessing by Client Software

The product CD contains the iVMS-4200 client software. You can view the live

video and manage the camera with the software.

Follow the installation prompts to install the software. The control panel and live view interface of iVMS-4200 client software are shown as below.

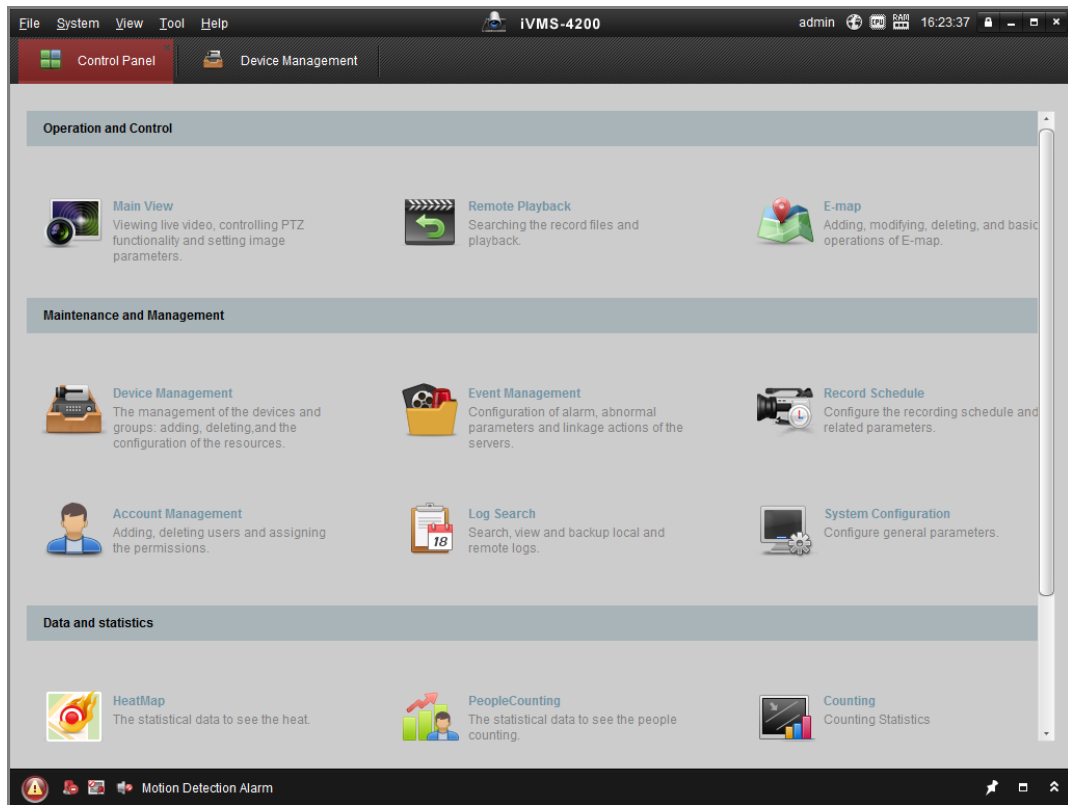

Figure 3-3 iVMS-4200 Control Panel

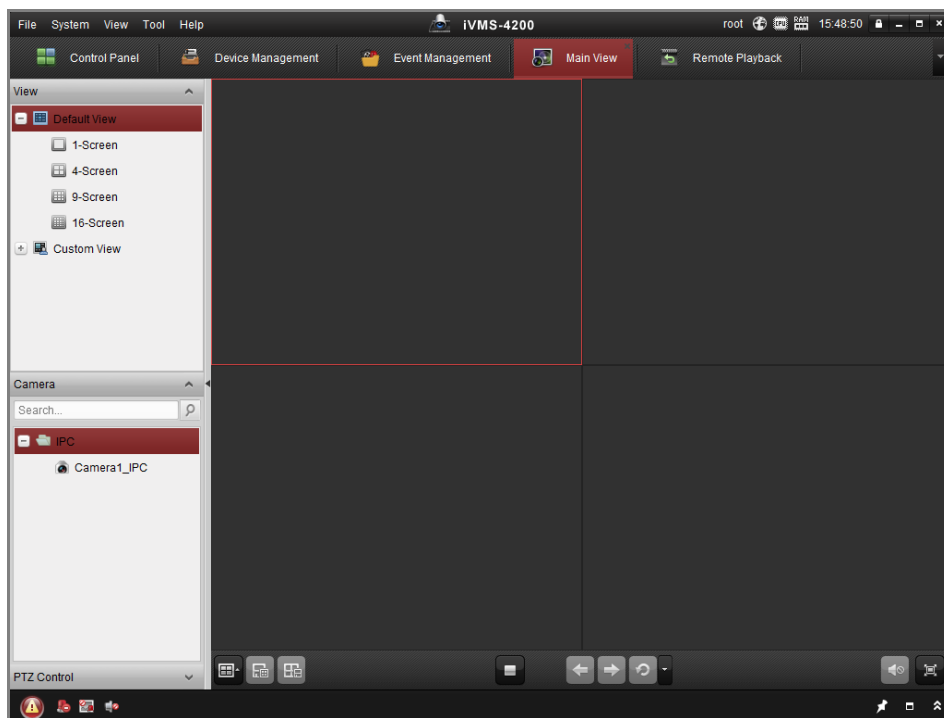

Figure 3-4 iVMS-4200 Main View

Chapter 4 Live View

4.1 Live View Page

Purpose:

The live view page allows you to view the real-time video, capture images, realize PTZ control, set/call presets and configure video parameters.

Log in the network camera to enter the live view page, or you can click **Live View** on the menu bar of the main page to enter the live view page.

Descriptions of the live view page:

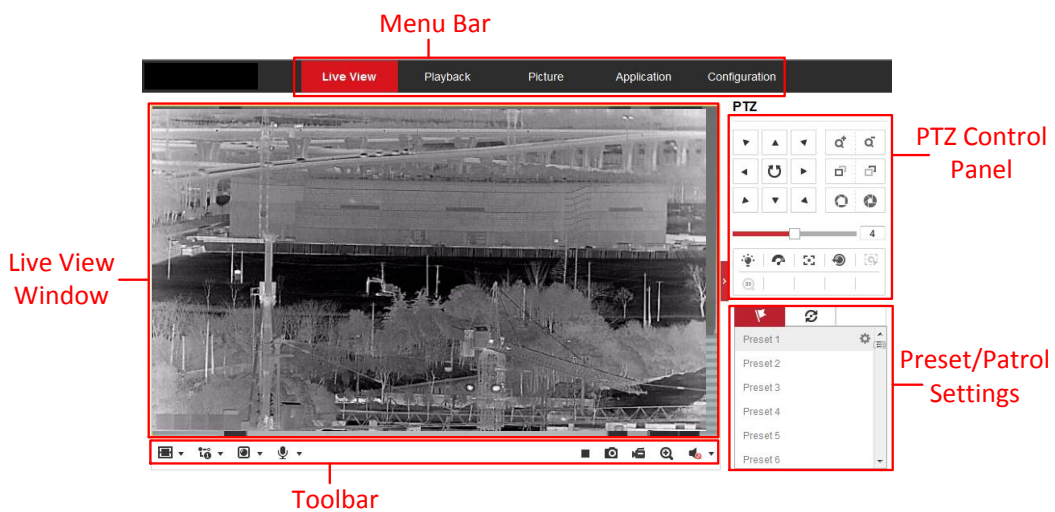

Figure 4-1 Live View Page

Menu Bar:

Click each tab to enter Live View, Playback, Picture, and Configuration page respectively.

Live View Window:

Display the live video.

Toolbar:

Toolbar allows you to adjust the live view window size, the stream type, and the plug-ins. It also allows you to process the operations on the live view page, e.g., start/stop live view, capture, record, audio on/off, two-way audio, start/stop digital zoom, etc.

For IE (Internet Explorer) users, plug-ins as webcomponents is selectable. And for Non-IE users, webcomponents, VLC or MJPEG is selectable if they are supported by the web browser.

PTZ Control:

Perform panning, tilting and zooming actions of the camera. Control the light and the wiper (only available for cameras supporting PTZ function).

Notes:

- This function varies according to different camera models.

The function may not be supported by some camera models

Preset/Patrol Settings:

Set/call/delete the presets or patrols for PTZ cameras.

4.2 Starting Live View

In the live view window as shown in Figure 4-2, click  on the toolbar to start the live view of the camera.

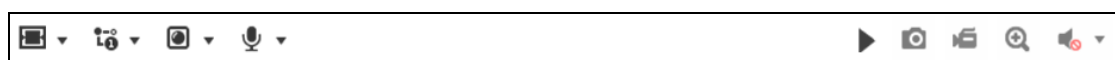









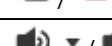

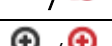
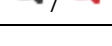



Figure 4-2 Live View Toolbar

Table 4-1 Descriptions of the Toolbar

Icon	Description
	Start/Stop live view.
	The window size is 4:3.
	The window size is 16:9.
	The original window size.
	Self-adaptive window size.
	Live view with the main stream.
	Live view with the sub stream.
	Live view with the third stream.
	Click to select the third-party plug-in.
	Manually capture the picture.
	Manually start/stop recording.
	Audio on and adjust volume /Mute.
	Turn on/off microphone.
	Start/stop digital zoom function.

Note: The icons vary according to the different camera models.

4.3 Recording and Capturing Pictures Manually

In the live view interface, click  on the toolbar to capture the live pictures or click  to record the live view. The saving paths of the captured pictures and clips can be set on the **Configuration > Local** page. To configure remote scheduled recording, please refer to *Section 10.1*.

Note: The captured image will be saved as JPEG file or BMP file in your computer.

4.4 Operating PTZ Control

Note: Certain models do not support the PTZ control. This section only applies



to the camera that supports PTZ control.

Purpose:

In the live view interface, you can use the PTZ control buttons to realize pan/tilt/zoom control of the camera.

Note: To realize PTZ control, the camera connected to the network must support the PTZ function or have a pan/tilt unit installed to the camera. Please properly set the PTZ parameters on RS485 settings page referring to *Section 5.2.3*.

4.4.1 PTZ Control Panel

On the live view page, click  next to the right side of the live view window to show the PTZ control panel and click  to hide it.

Click the direction buttons to control the pan/tilt movements.

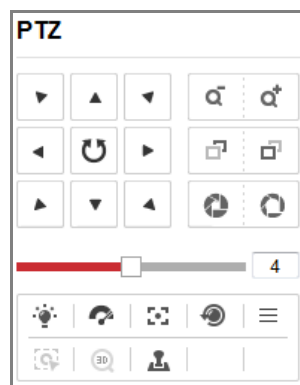

Figure 4-3 PTZ Control Panel

Click the zoom/focus/iris buttons to realize lens control.

Notes:

There are eight direction arrows (, , , , , , , ) in the

control panel. Click the arrows to realize adjustment in the relative positions.

For the cameras which support lens movements only, the direction buttons are invalid.

Table 4-2 Descriptions of PTZ Control Panel

Icon	Description
	Zoom in/out
	Focus near/far
	Iris +/-
	PTZ speed adjustment
	Light on/off
	Wiper on/off
	Auxiliary focus
	Initialize lens
	Adjust speed of pan/tilt
	Start Manual Tracking
	Drag a rectangular to start 3D
	Enable De-icing Heater
	Preset
	Patrol

4.4.2 Setting/Calling a Preset

Setting a Preset:

1. In the PTZ control panel, select a preset number from the preset list.

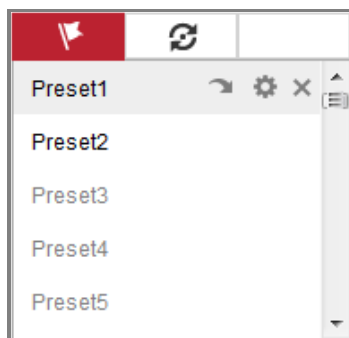





Figure 4-4 Setting a Preset

2. Use the PTZ control buttons to move the lens to the desired position.
 - Pan the camera to the right or left.
 - Tilt the camera up or down.
 - Zoom in or out.
 - Refocus the lens.
3. Click  to finish the setting of the current preset.
4. You can click  to delete the preset, or double-click to edit the preset name.

Calling a Preset:

This feature enables the camera to point to a specified preset scene manually or when an event takes place.

For the defined preset, you can call it at any time to the desired preset scene.

In the PTZ control panel, select a defined preset from the list and click  to call the preset.

Or you can place the mouse on the presets interface, and call the preset by typing the preset No. to call the corresponding presets.

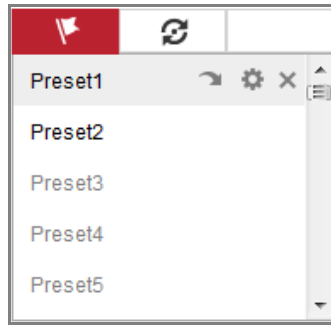



Figure 4-5 Calling a Preset

4.4.3 Setting/Calling a Patrol

Note:

No less than 2 presets have to be configured before you set a patrol.

Steps:

1. Click  to enter the patrol configuration interface.
2. Select a path No., and click  to add the configured presets.
3. Select the preset, and input the patrol duration and patrol speed.
4. Click OK to save the first preset.
5. Follow the steps above to add the other presets.

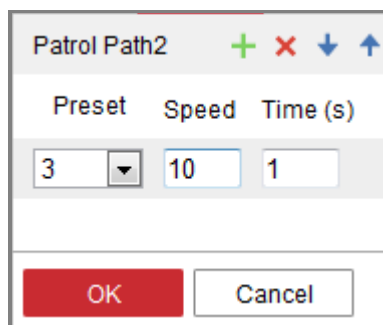



Figure 4-6 Add Patrol Path

6. Click **OK** to save a patrol.
7. Click  to start the patrol, and click  to stop it.

8. (Optional) Click  to delete a patrol.

Chapter 5 Network Camera Configuration

5.1 Configuring Local Parameters

Purpose:

The local configuration refers to the parameters of the live view, record files and captured pictures. The record files and captured pictures are the ones you record and capture using the web browser and thus the saving paths of them are on the PC running the browser.

Steps:

1. Enter the Local Configuration interface: **Configuration > Local**.

Live View Parameters			
Protocol	<input checked="" type="radio"/> TCP	<input type="radio"/> UDP	<input type="radio"/> MULTICAST <input type="radio"/> HTTP
Play Performance	<input type="radio"/> Shortest Delay	<input checked="" type="radio"/> Balanced	<input type="radio"/> Fluent
Rules	<input type="radio"/> Enable	<input checked="" type="radio"/> Disable	
Image Format	<input checked="" type="radio"/> JPEG	<input type="radio"/> BMP	
Fire Point	<input type="checkbox"/> Locate Highest Te...	<input type="checkbox"/> Frame Fire Point	
Record File Settings			
Record File Size	<input type="radio"/> 256M	<input checked="" type="radio"/> 512M	<input type="radio"/> 1G
Save record files to	<input type="text" value="C:\Web\RecordFiles"/>	<input type="button" value="Browse"/>	<input type="button" value="Open"/>
Save downloaded files to	<input type="text" value="C:\Web\DownloadFiles"/>	<input type="button" value="Browse"/>	<input type="button" value="Open"/>
Picture and Clip Settings			
Save snapshots in live view to	<input type="text" value="C:\Web\CaptureFiles"/>	<input type="button" value="Browse"/>	<input type="button" value="Open"/>
Save snapshots when playback to	<input type="text" value="C:\Web\PlaybackPics"/>	<input type="button" value="Browse"/>	<input type="button" value="Open"/>
Save clips to	<input type="text" value="C:\Web\PlaybackFiles"/>	<input type="button" value="Browse"/>	<input type="button" value="Open"/>

Live View Parameters				
Protocol	<input checked="" type="radio"/> TCP	<input type="radio"/> UDP	<input type="radio"/> MULTICAST	<input type="radio"/> HTTP
Play Performance	<input type="radio"/> Shortest Delay	<input checked="" type="radio"/> Balanced	<input type="radio"/> Fluent	
Rules	<input type="radio"/> Enable	<input checked="" type="radio"/> Disable		
Image Format	<input checked="" type="radio"/> JPEG	<input type="radio"/> BMP		
Display Temperature Info.	<input type="radio"/> Yes	<input checked="" type="radio"/> No		
Display Temperature Info. on Capt...	<input type="radio"/> Yes	<input checked="" type="radio"/> No		

Figure 5-1 Local Configuration Interface

- Configure the following settings:

Live View Parameters: Set the protocol type and live view performance.

Protocol Type: TCP, UDP, MULTICAST and HTTP are selectable.

TCP: Ensures complete delivery of streaming data and better video quality, yet the real-time transmission will be affected.

UDP: Provides real-time audio and video streams.

HTTP: Allows the same quality as of TCP without setting specific ports for streaming under some network environments.

MULTICAST: It's recommended to select MCAST type when using the Multicast function. For detailed information about Multicast, refer to *Section 6.1.1*.

Play Performance: Set the play performance to Shortest Delay or Auto.

Rules: It refers to the rules on your local browser, select enable or disable to display or not display the colored marks when the motion detection, fire detection, or intrusion detection is triggered. E.g., enabled as the rules are, and the fire detection is enabled as well, when a fire is detected, it will be marked with a green rectangle on the live view.

Image Format: Choose the image format for picture capture.

Fire Point: **Locate Highest Temperature Point**, and **Frame Fire Point** are selectable. Display the highest temperature area as point or frame.

Display Temperature Info.: Display temperature information or not with temperature measurement rule configured.

Display Temperature Info. on Capture: Display temperature information on the capture or not.

Record File Settings: Set the saving path of the recorded video files. Valid for the record files you recorded with the web browser.

Record File Size: Select the packed size of the manually recorded and downloaded video files to 256M, 512M or 1G. After the selection, the maximum record file size is the value you selected.

Save record files to: Set the saving path for the manually recorded video files.

Save downloaded files to: Set the saving path for the downloaded video files in playback mode.

Picture and Clip Settings: Set the saving paths of the captured pictures and clipped video files. Valid for the pictures you capture with the web browser.

Save snapshots in live view to: Set the saving path of the manually captured pictures in live view mode.

Save snapshots when playback to: Set the saving path of the captured pictures in playback mode.

Save clips to: Set the saving path of the clipped video files in playback mode.

Note: You can click **Browse** to change the directory for saving the clips and pictures, and click **Open** to open the set folder of clips and picture saving.

3. Click **Save** to save the settings.

5.2 Configure System Settings

Purpose:

Follow the instructions below to configure the system settings, include System Settings, Maintenance, Security, and User Management, etc.

5.2.1 Configuring Basic Information

Enter the Device Information interface: **Configuration** > **System** > **System Settings** > **Basic Information**.

In the **Basic Information** interface, you can edit the Device Name and Device No.

Other information of the network camera, such as Model, Serial No., Firmware Version, Encoding Version, Number of Channels, Number of HDDs, Number of Alarm Input and Number of Alarm Output are displayed. The information cannot be changed in this menu. It is the reference for maintenance or modification in future.

Basic Information	Time Settings	DST	RS-232	About
Device Name	<input type="text" value="THERMAL CAMERA"/>			
Device No.	<input type="text" value="88"/>			
Model	<input type="text"/>			
Serial No.	<input type="text"/>			
Firmware Version	<input type="text"/>			
Encoding Version	<input type="text"/>			
Web Version	<input type="text"/>			
Plugin Version	<input type="text"/>			
Camera Module Version	<input type="text"/>			
Number of Channels	<input type="text" value="1"/>			
Number of HDDs	<input type="text" value="0"/>			
Number of Alarm Input	<input type="text" value="2"/>			
Number of Alarm Output	<input type="text" value="2"/>			
<input type="button" value="Save"/>				

Figure 5-2 Basic Information

Online Upgrade

For some camera models, when memory card is mounted, you can click the **Update** button that appears on the right of **Firmware Version** text field to see if there is a new version available. If a new version is available, the version number will be displayed in the **New Version** text field below, and you can click the **Upgrade** button to upgrade the firmware for the camera.

<i>Firmware Version</i>	<input type="text" value="VX.X.X build XXXXXX"/>	<input type="button" value="Update"/>
<i>New Version</i>	<input type="text" value="VX.X.X build XXXXXX"/>	<input type="button" value="Upgrade"/>

Figure 5-3 Online Upgrade

Note: When the camera is upgrading, don't power off the camera. During upgrading, the camera may not be accessible. You need to wait 1 or 2 minutes

before the upgrade finishes.

5.2.2 Configuring Time Settings

Purpose:

You can follow the instructions in this section to configure the time synchronization and DST settings.

Steps:

1. Enter the Time Settings interface, **Configuration > System > System Settings > Time Settings**.

The screenshot shows the 'Time Settings' configuration page. At the top, there are navigation tabs: 'Basic Information', 'Time Settings' (highlighted in red), 'DST', 'RS-232', and 'About'. Below the tabs, the 'Time Zone' is set to '(GMT+08:00) Beijing, Urumqi, Singapore'. The 'NTP' section is active, with the 'NTP' radio button selected. The 'Server Address' is 'time.windows.com', 'NTP Port' is '123', and 'Interval' is '1440 minute(s)'. There is a 'Test' button below the interval field. The 'Manual Time Sync.' section has the 'Manual Time Sync.' radio button selected. The 'Device Time' is '2018-05-19T15:11:20' and the 'Set Time' is '2018-05-19T15:11:09'. There is a checkbox for 'Sync. with computer time' which is unchecked. A red 'Save' button is located at the bottom of the form.

Figure 5-4 Time Settings

2. Select the Time Zone of your location from the drop-down menu.
3. Configure the NTP settings.

(1) Click to enable the **NTP** function.

(2) Configure the following settings:

Server Address: IP address of NTP server.

NTP Port: Port of NTP server.

Interval: The time interval between the two synchronizing actions with NTP server.

(3) (Optional) You can click the **Test** button to test the time synchronization function via NTP server.

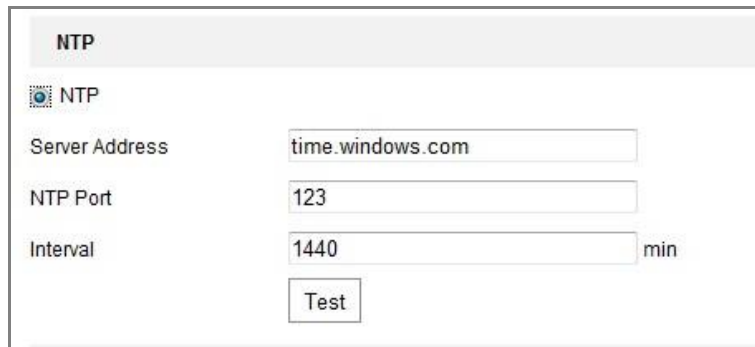

NTP	
<input checked="" type="checkbox"/> NTP	
Server Address	<input type="text" value="time.windows.com"/>
NTP Port	<input type="text" value="123"/>
Interval	<input type="text" value="1440"/> min
<input type="button" value="Test"/>	

Figure 5-5 Time Sync by NTP Server

Note: If the camera is connected to a public network, you should use a NTP server that has a time synchronization function, such as the server at the National Time Center (IP Address: 210.72.145.44). If the camera is set in a customized network, NTP software can be used to establish a NTP server for time synchronization.

Configure the manual time synchronization.

(1) Check the **Manual Time Sync.** item to enable the manual time synchronization function.

(2) Click the icon  to select the date, time from the pop-up calendar.

- (3) (Optional) You can check **Sync. with computer time** item to synchronize the time of the device with that of the local PC.



Figure 5-6 Time Sync Manually

Click **Save** to save the settings.

5.2.3 Configuring RS232 Settings

Steps:

1. Enter RS-232 Port Setting interface: **Configuration > System > System Settings > RS232.**

Basic Information	Time Settings	DST	RS-232	About
Baud Rate	115200			
Data Bit	8			
Stop Bit	1			
Parity	None			
Flow Ctrl	None			
Usage	Console			
<div style="background-color: red; color: white; padding: 5px; display: inline-block; border-radius: 5px;"> Save </div>				

Figure 5-7 RS-232 Settings

2. Set the RS232 parameters and click **Save** to save the settings.

5.2.4 Configuring DST Settings

Purpose:

Daylight Saving Time (DST) is a way of making better use of the natural daylight by setting your clock forward one hour during the summer months, and back again in the fall.

Configure the DST according to your actual demand.

Steps:

1. Enter the DST configuration interface.

Configuration > System > System Settings > DST

Basic Information	Time Settings	DST	RS-232	About
<input type="checkbox"/> Enable DST				
Start Time	Apr	First	Sun	02
End Time	Oct	Last	Sun	02
DST Bias	30minute(s)			
Save				

Figure 5-8 DST Settings

2. Select the start time and the end time.
3. Select the DST Bias.
4. Click **Save** to activate the settings.

5.2.5 Viewing License

Purpose:

You can view the open source software licenses that are applied to the IP camera.

Steps:

1. Enter About Device interface: **Configuration > System > System Settings > About** .
2. Click **View Licenses**.

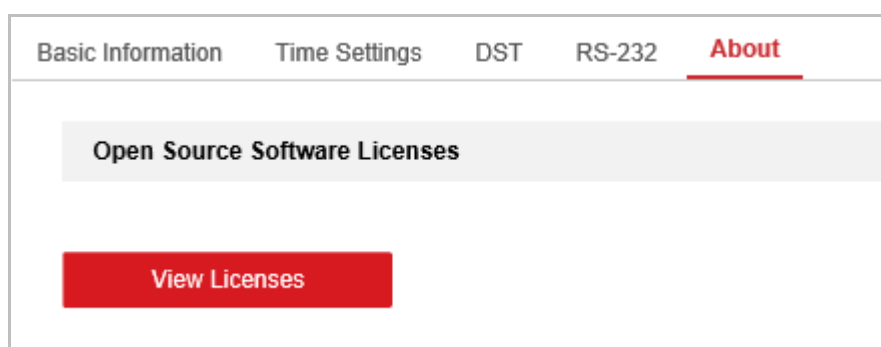

Figure 5-9 About Device Interface

5.3 Maintenance

5.3.1 Upgrade & Maintenance

Purpose:

The upgrade & maintenance interface allows you to process the operations, including reboot, partly restore, restore to default, export/import the configuration files, and upgrade the device.

Enter the Maintenance interface: **Configuration > System > Maintenance >**

Upgrade & Maintenance.

Reboot: Restart the device.

Restore: Reset all the parameters, except the IP parameters and user information, to the default settings.

Default: Restore all the parameters to the factory default.

Note: After restoring the default settings, the IP address is also restored to the default IP address, please be careful for this action.

Export/Import Config. File: Configuration file is used for the batch configuration of the camera, which can simplify the configuration steps when there are a lot of cameras needing configuring.

Steps:

1. Click **Device Parameters** to export the current configuration file, and save it to certain place.
2. Click **Browse** to select the saved configuration file and then click **Import** to start importing configuration file.

Note: You need to reboot the camera after importing configuration file.

Upgrade: Upgrade the device to a certain version.

Steps:

1. Select firmware or firmware directory to locate the upgrade file.

Firmware: Locate the exact path of the upgrade file.

Firmware Directory: Only the directory the upgrade file belongs to is required.

- Click **Browse** to select the local upgrade file and then click **Upgrade** to start remote upgrade.

Note: The upgrading process will take 1 to 10 minutes. Please don't disconnect power of the camera during the process, and the camera reboots automatically after upgrade.

5.3.2 Log

Purpose:

The operation, alarm, exception and information of the camera can be stored in log files. You can also export the log files on your demand.

Before you start:

Please configure network storage for the camera or insert a SD card in the camera.

Steps:

- Enter log searching interface: **Configuration > System > Maintenance > Log.**

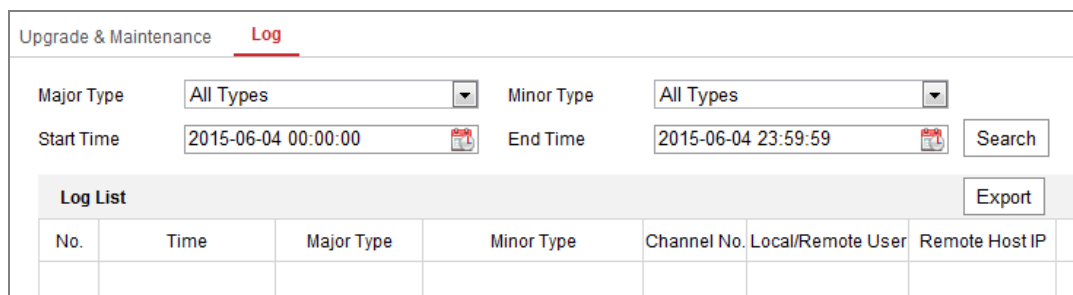

Upgrade & Maintenance		Log						
Major Type	All Types	Minor Type	All Types	Start Time	2015-06-04 00:00:00	End Time	2015-06-04 23:59:59	Search
Log List								Export
No.	Time	Major Type	Minor Type	Channel No.	Local/Remote User	Remote Host IP		

Figure 5-10 Log Searching Interface

- Set the log search conditions to specify the search, including the Major Type, Minor Type, Start Time and End Time.

- Click **Search** to search log files. The matched log files will be displayed on the log list interface.

No.	Time	Major Type	Minor Type	Channel No.	Local/Remote User	Remote Host IP
1	2015-05-25 19:12:34	Operation	Remote: Get Working Sta...		admin	10.16.1.107
2	2015-05-25 19:12:12	Operation	Remote: Get Working Sta...		admin	10.16.1.107
3	2015-05-25 19:12:12	Operation	Remote: Get Working Sta...		admin	10.16.1.107
4	2015-05-25 19:12:12	Operation	Remote: Get Working Sta...		admin	10.16.1.107
5	2015-05-25 19:12:11	Operation	Remote: Get Working Sta...		admin	10.16.1.107
6	2015-05-25 19:12:11	Operation	Remote: Get Working Sta...		admin	10.16.1.107
7	2015-05-25 19:12:11	Operation	Remote: Get Working Sta...		admin	10.16.1.107
8	2015-05-25 19:12:10	Operation	Remote: Get Working Sta...		admin	10.16.1.107
9	2015-05-25 19:09:28	Operation	Remote: Get Parameters		admin	10.16.1.107
10	2015-05-25 19:09:25	Operation	Remote: Get Parameters		admin	10.16.1.107
11	2015-05-25 19:09:25	Operation	Remote: Get Parameters		admin	10.16.1.107
12	2015-05-25 19:09:24	Operation	Remote: Get Parameters		admin	10.16.1.107

Total 614 Items

Figure 5-11 Log Searching

- To export the log files, click **Export** to save the log files.

5.3.3 System Service

Purpose:

System service settings refer to the hardware service the camera supports. Supported functions vary according to the different cameras. For the cameras support Automatic De-Icing, IR LED, Supplement Light, ABF (Auto Back Focus), Auto Defog, or Status LED, you can select to enable or disable the corresponding service according to the actual demands.

Automatic De-Icing: You can check the checkbox to enable Automatic De-Icing

function of the device. The de-icing heater is only supported under POE+, 24VAC, or 12VDC power supply.

ABF: When ABF function is enabled, you can click  on PTZ control panel to realize auxiliary focus.

Supplement Light: For some models, you can check the checkbox of **Enable Supplement Light** to reboot the system and enable the supplement light.

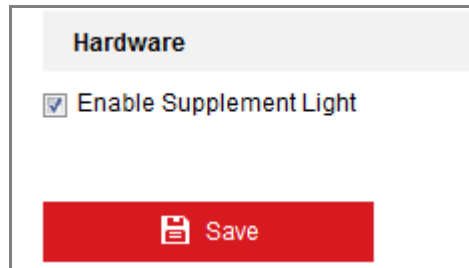

Figure 5-12 Enable Supplement Light

5.3.4 VCA Resource Type

Purpose:

VCA resource offers you options to enable certain VCA functions according to actual need when several VCA functions are available. It helps allocate more resources to the wanted functions.

Steps:

1. Enter VCA Resource Type interface: **Configuration > System > Maintenance > VCA Resource Type.**

The figure displays two screenshots of the 'VCA Resource Configuration' interface. Both screenshots have a title bar 'VCA Resource Configuration' and a red 'Save' button with a floppy disk icon.

The top screenshot shows two radio button options: 'Temperature Measurement+Behavior Analysis' (unselected) and 'Temperature Measurement+Fire Detection' (selected).

The bottom screenshot shows two radio button options: 'Temperature Measurement+Open Platform' (selected) and 'Temperature Measurement+Fire Detection' (unselected).

Figure 5-13 VCA Resource Type

2. Check the checkbox to enable the desired VCA resource type.
3. Click **Save**. A reboot is required after setting the VCA Resource.

Notes:

- VCA Resource function varies according to different camera models.
- The function may not be supported by some camera models.

5.4 Security Settings

Configure the parameters, including Authentication, Anonymous Visit, IP Address Filter, and Security Service from security interface.

5.4.1 Authentication

Purpose:

You can specifically secure the stream data of live view.

Steps:

1. Enter the Authentication interface: **Configuration > System > Security > Authentication**.

The screenshot shows the 'Authentication' configuration page. At the top, there are three tabs: 'Authentication' (highlighted in red), 'IP Address Filter', and 'Security Service'. Below the tabs, there are two rows of configuration options. The first row is 'RTSP Authentication' with a dropdown menu set to 'digest'. The second row is 'WEB Authentication' with a dropdown menu also set to 'digest'. At the bottom of the page, there is a prominent red button with a white floppy disk icon and the text 'Save'.

Figure 5-14 RTSP / WEB Authentication

2. Select the RTSP /WEB **Authentication** type **digest** or **digest/basic** in the drop-down list.
3. Click **Save** to save the settings.

5.4.2 IP Address Filter

Purpose:

This function makes it possible for access control.

Steps:

1. Enter the IP Address Filter interface: **Configuration > System > Security > IP Address Filter**

The screenshot shows the 'IP Address Filter' configuration page. At the top, there are three tabs: 'Authentication', 'IP Address Filter' (highlighted in red), and 'Security Service'. Below the tabs, there is a checkbox labeled 'Enable IP Address Filter' which is checked. Below that is a dropdown menu for 'IP Address Filter Type' set to 'Forbidden'. At the bottom, there is a table with the title 'IP Address Filter' and three buttons: 'Add', 'Modify', and 'Delete'. The table has two columns: 'No.' and 'IP'. The table is currently empty.

Figure 5-15 IP Address Filter Interface

2. Check the checkbox of **Enable IP Address Filter**.
3. Select the type of IP Address Filter in the drop-down list, **Forbidden** and **Allowed** are selectable.
4. Set the IP Address Filter list.

Add an IP Address

Steps:

- (1) Click the **Add** to add an IP.
- (2) Input the IP Address.

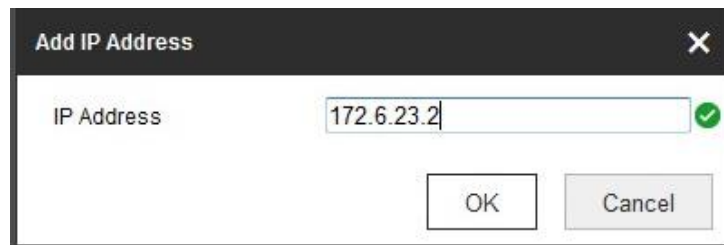

Figure 5-16 Add an IP

- (3) Click the **OK** to finish adding.

Modify an IP Address

Steps:

- (1) Left-click an IP address from filter list and click **Modify**.
- (2) Modify the IP address in the text field.

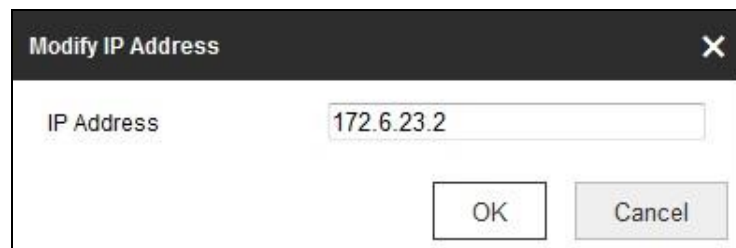

Figure 5-17 Modify an IP

- (3) Click the **OK** to finish modifying.

Delete an IP Address or IP Addresses.

Select the IP address(es) and click **Delete**.

5. Click **Save** to save the settings.

5.4.3 Security Service

To enable the remote login, and improve the data communication security, the camera provides the security service for better user experience.

Steps:

1. Enter the security service configuration interface: **Configuration > System > Security > Security Service**.

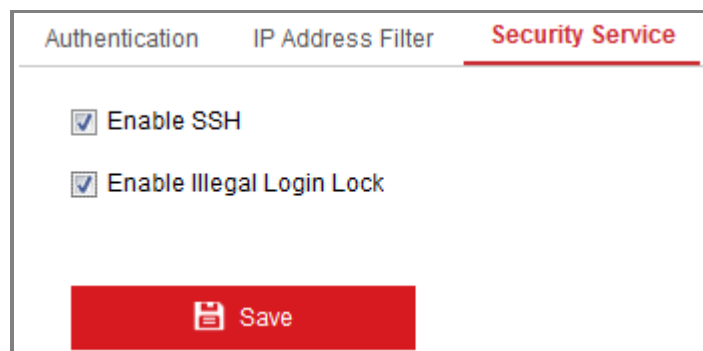

Figure 5-18 Security Service

2. Check the checkbox of **Enable SSH** to enable the data communication security, and uncheck the checkbox to disable the SSH.
3. Check the checkbox of **Enable Illegal Login Lock**, and then the IP address will be locked if the admin user performs 7 failed user name/password attempts (5 times for the operator/user).

Note: If the IP address is locked, you can try to login the device after 30

minutes.

5.5 User Management

5.5.1 User Management

Purpose:

The admin user can add, delete or modify user accounts, and grant them different permissions. We highly recommend you manage the user accounts and permissions properly.

Steps:

1. Enter the User Management interface: **Configuration >System >User Management**

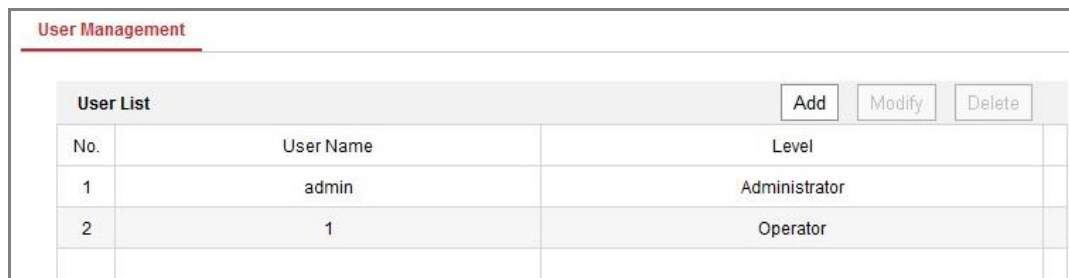

User Management		
User List		
		Add Modify Delete
No.	User Name	Level
1	admin	Administrator
2	1	Operator

Figure 5-19 User Management Interface

Adding a User

The *admin* user has all permissions by default and can create/modify/delete other accounts.

The *admin* user cannot be deleted and you can only change the *admin* password.

Steps:

1. Click **Add** to add a user.
2. Input the **User Name**, select **Level** and input **Password**.

Notes:

- Up to 31 user accounts can be created.
- Users of different levels own different default permissions. Operator and user are selectable.



STRONG PASSWORD RECOMMENDED—We highly recommend

you create a strong password of your own choosing (using a minimum of 8 characters, including at least three of the following categories: upper case letters, lower case letters, numbers, and special characters) in order to increase the security of your product. And we recommend you reset your password regularly, especially in the high security system, resetting the password monthly or weekly can better protect your product.

3. You can check or uncheck the permissions for the new user.
4. Click **OK** to finish the user addition.

Add user

User Name: Test ✓

Level: Operator

Password: ●●●●●● ✓
Strong
Valid password range [8-16]. You can use a combination of numbers, letters, and special characters.

Confirm: ●●●●●● ✓

- Select All
- Remote: Parameters Settings
- Remote: Log Search / Interrogate Wo...
- Remote: Upgrade / Format
- Remote: Two-way Audio
- Remote: Shutdown / Reboot
- Remote: Notify Surveillance Center / ...
- Remote: Video Output Control
- Remote: Serial Port Control
- Remote: Live View
- Remote: Manual Record
- Remote: PTZ Control
- Remote: Playback

Figure 5-20 Add a User

Modifying a User

Steps:

1. Left-click to select the user from the list and click **Modify**.
2. Modify the **User Name**, **Level** and **Password**.



STRONG PASSWORD RECOMMENDED—We highly recommend you create a strong password of your own choosing (using a minimum of 8 characters, including at least three of the following categories: upper case letters, lower case letters, numbers, and special characters) in order to increase the security of your product. And we recommend you reset your password regularly, especially in the high security system, resetting the password monthly or weekly can better protect your product.

3. You can check or uncheck the permissions.
4. Click **OK** to finish the user modification.

Modify user

User Name: Test

Level: Operator

Password: [masked] ✓ Strong
Valid password range [8-16]. You can use a combination of numbers, letters, and special characters.

Confirm: [masked] ✓

Select All

- Remote: Parameters Settings
- Remote: Log Search / Interrogate Wo...
- Remote: Upgrade / Format
- Remote: Two-way Audio
- Remote: Shutdown / Reboot
- Remote: Notify Surveillance Center /...
- Remote: Video Output Control
- Remote: Serial Port Control
- Remote: Live View
- Remote: Manual Record
- Remote: PTZ Control
- Remote: Playback

Figure 5-21 Modify a User

Deleting a User

Steps:

1. Click to select the user you want to delete and click **Delete**.
2. Click **OK** on the pop-up dialogue box to confirm the deletion.

Chapter 6 Network Settings

Purpose:

Follow the instructions in this chapter to configure the basic settings and advanced settings.

6.1 Configuring Basic Settings

Purpose:

You can configure the parameters, including TCP/IP, DDNS, PPPoE, Port, and NAT, etc., by following the instructions in this section.

6.1.1 Configuring TCP/IP Settings

Purpose:

TCP/IP settings must be properly configured before you operate the camera over network. The camera supports both the IPv4 and IPv6. Both versions can be configured simultaneously without conflicting to each other, and at least one IP version should be configured.

Steps:

1. Enter TCP/IP Settings interface: **Configuration > Network > Basic Settings > TCP/IP**

The screenshot shows the TCP/IP configuration page. At the top, there are tabs for TCP/IP, DDNS, PPPoE, Port, and NAT. The TCP/IP tab is selected. The settings are as follows:

- NIC Type: Auto
- DHCP
- IPv4 Address: 10.11.37.120 (with a Test button)
- IPv4 Subnet Mask: 255.255.255.0
- IPv4 Default Gateway: 10.11.37.254
- IPv6 Mode: Route Advertisement (with a View Route Advertisement button)
- IPv6 Address: ::
- IPv6 Subnet Mask: 0
- IPv6 Default Gateway: ::
- Mac Address: c0:56:e3:60:27:5d
- MTU: 1500
- Multicast Address: (empty)
- Enable Multicast Discovery

A section titled "DNS Server" contains:

- Preferred DNS Server: 8.8.8.8
- Alternate DNS Server: (empty)

A red "Save" button is located at the bottom left of the form.

Figure 6-1 TCP/IP Settings

2. Configure the basic network settings, including the NIC Type, IPv4 or IPv6 Address, IPv4 or IPv6 Subnet Mask, IPv4 or IPv6 Default Gateway, MTU settings and Multicast Address.
3. (Optional) Check the checkbox of **Enable Multicast Discovery**, and then the online network camera can be automatically detected by client software via private multicast protocol in the LAN.
4. Configure the DNS server. Input the preferred DNS server, and alternate DNS server.
5. Click **Save** to save the above settings.

Notes:

The valid value range of MTU is 1280 ~ 1500.

The Multicast sends a stream to the multicast group address and allows multiple clients to acquire the stream at the same time by requesting a copy from the multicast group address. Before utilizing this function, you have to enable the Multicast function of your router.

A reboot is required for the settings to take effect.

6.1.2 Configuring DDNS Settings

Purpose:

If your camera is set to use PPPoE as its default network connection, you can use the Dynamic DNS (DDNS) for network access.

Before you start:

Registration on the DDNS server is required before configuring the DDNS settings of the camera.

Steps:

1. Enter the DDNS Settings interface: **Configuration > Network > Basic Settings > DDNS**.
2. Check the **Enable DDNS** checkbox to enable this feature.
3. Select **DDNS Type**. Two DDNS types are selectable: DynDNS and NO-IP.

DynDNS:

Steps:

- (1) Enter **Server Address** of DynDNS (e.g. members.dyndns.org).

- (2) In the **Domain** text field, enter the domain name obtained from the DynDNS website.
- (3) Enter the **User Name** and **Password** registered on the DynDNS website.
- (4) Click **Save** to save the settings.

TCP/IP **DDNS** PPPoE Port NAT

Enable DDNS

DDNS Type: DynDNS

Server Address: members.dyndns.org ✓

Domain: 123.dyndns.com ✓

User Name: test ✓

Port: 0

Password: ●●●●●● ✓

Confirm: ●●●●●● ✓

Save

Figure 6-2 DynDNS Settings

NO-IP:

Steps:

- (1) Choose the DDNS Type as NO-IP.

TCP/IP **DDNS** PPPoE Port NAT

Enable DDNS

DDNS Type: NO-IP

Server Address: www.noip.com ✓

Domain:

User Name:

Port: 0

Password:

Confirm:

Save

Figure 6-3 NO-IP DNS Settings

- (2) Enter the Server Address as www.noip.com
- (3) Enter the Domain name you registered.
- (4) Enter the User Name and Password.
- (5) Click **Save** and then you can view the camera with the domain name.

Note: Reboot the device to make the settings take effect.

6.1.3 Configuring PPPoE Settings

Steps:

1. Enter the PPPoE Settings interface: **Configuration > Network > Basic Settings > PPPoE**

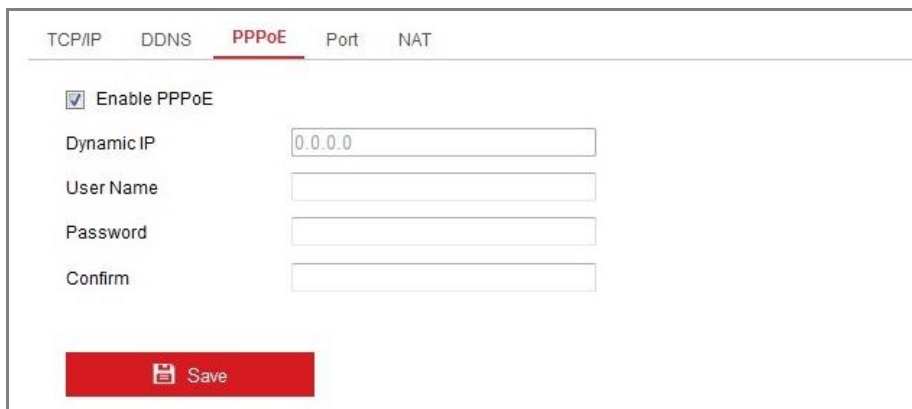

The screenshot shows the PPPoE configuration page. At the top, there are navigation tabs: TCP/IP, DDNS, PPPoE (highlighted in red), Port, and NAT. Below the tabs, the 'Enable PPPoE' checkbox is checked. The 'Dynamic IP' field contains '0.0.0.0'. The 'User Name', 'Password', and 'Confirm' fields are empty. A red 'Save' button is located at the bottom left of the form area.

Figure 6-4 PPPoE Settings

2. Check the **Enable PPPoE** checkbox to enable this feature.
3. Enter **User Name**, **Password**, and **Confirm** password for PPPoE access.

Note: The User Name and Password should be assigned by your ISP.



For your privacy and to better protect your system against security risks, we strongly recommend the use of strong passwords for all functions and network devices. The password should be something of your own choosing (using a minimum of 8 characters, including at least three of the following categories: upper case letters, lower case letters, numbers and special characters) in order to increase the security of your product.

Proper configuration of all passwords and other security settings is the responsibility of the installer and/or end-user.

4. Click **Save** to save and exit the interface.

Note: A reboot is required for the settings to take effect.

6.1.4 Configuring Port Settings

Purpose:

You can set the port No. of the camera, e.g., HTTP port, RTSP port and HTTPS port.

Steps:

1. Enter the Port Settings interface, **Configuration > Network > Basic Settings > Port**

Setting	Value
HTTP Port	80
RTSP Port	554
HTTPS Port	443
Server Port	8000

Figure 6-5 Port Settings

2. Set the HTTP port, RTSP port, HTTPS port and server port of the camera.

HTTP Port: The default port number is 80, and it can be changed to any port No. which is not occupied.

RTSP Port: The default port number is 554 and it can be changed to any port No. ranges from 1 to 65535.

HTTPS Port: The default port number is 443, and it can be changed to any port No. which is not occupied.

Server Port: The default server port number is 8000, and it can be changed to any port No. ranges from 2000 to 65535.

3. Click **Save** to save the settings.

Note: A reboot is required for the settings to take effect.

6.1.5 Configure NAT (Network Address Translation) Settings

Purpose:

NAT interface allows you to configure the UPnP™ parameters.

Universal Plug and Play (UPnP™) is a networking architecture that provides compatibility among networking equipment, software and other hardware

devices. The UPnP protocol allows devices to connect seamlessly and to simplify the implementation of networks in the home and corporate environments.

With the function enabled, you don't need to configure the port mapping for each port, and the camera is connected to the Wide Area Network via the router.

Steps:

1. Enter the NAT settings interface. **Configuration > Network > Basic Settings > NAT.**
2. Check the checkbox to enable the UPnP™ function.
3. Choose a nickname for the camera, or you can use the default name.
4. Select the port mapping mode. Manual and Auto are selectable. And for manual port mapping, you can customize the value of the external port.
5. Click **Save** to save the settings.

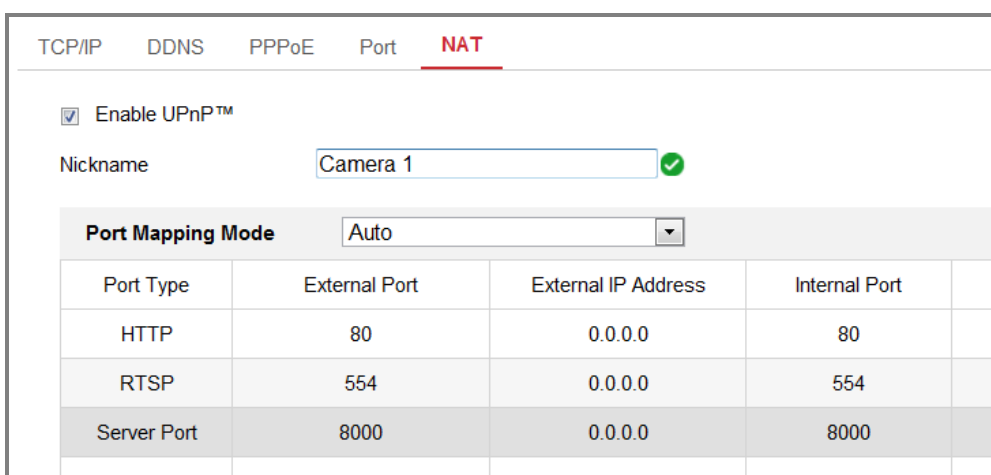

The screenshot shows the NAT configuration page with the following settings:

- Enable UPnP™:
- Nickname: Camera 1
- Port Mapping Mode: Auto

Port Type	External Port	External IP Address	Internal Port
HTTP	80	0.0.0.0	80
RTSP	554	0.0.0.0	554
Server Port	8000	0.0.0.0	8000

Figure 6-6 UPnP Settings

6.2 Configure Advanced Settings

Purpose:

You can configure the parameters, including SNMP, FTP, Email, HTTPS, QoS, 802.1x, etc., by following the instructions in this section.

6.2.1 Configuring SNMP Settings

Purpose:

You can set the SNMP function to get camera status, parameters and alarm related information, and manage the camera remotely when it is connected to the network.

Before you start:

Before setting the SNMP, please download the SNMP software and manage to receive the camera information via SNMP port. By setting the Trap Address, the camera can send the alarm event and exception messages to the surveillance center.

Note: The SNMP version you select should be the same as that of the SNMP software. And you also need to use the different version according to the security level you required. SNMP v1 provides no security and SNMP v2 requires password for access. And SNMP v3 provides encryption and if you use the third version, HTTPS protocol must be enabled.



For your privacy and to better protect your system against security risks, we

strongly recommend the use of strong passwords for all functions and network devices. The password should be something of your own choosing (using a minimum of 8 characters, including at least three of the following categories: upper case letters, lower case letters, numbers and special characters) in order to increase the security of your product.

Proper configuration of all passwords and other security settings is the responsibility of the installer and/or end-user.

Steps:

1. Enter the SNMP Settings interface: **Configuration > Network > Advanced Settings > SNMP.**

SNMP v1/v2

Enable SNMPv1

Enable SNMP v2c

Read SNMP Community

Write SNMP Community

Trap Address

Trap Port

Trap Community

SNMP v3

Enable SNMPv3

Read UserName

Security Level

Authentication Algorithm MD5 SHA

Authentication Password

Private-key Algorithm DES AES

Private-key password

Write UserName

Security Level

Authentication Algorithm MD5 SHA

Authentication Password

Private-key Algorithm DES AES

Private-key password

SNMP Other Settings

SNMP Port

Figure 6-7 SNMP Settings

2. Check the checkbox of Enable SNMPv1, Enable SNMP v2c, Enable SNMPv3 to enable the feature correspondingly.
3. Configure the SNMP settings.

Note: The settings of the SNMP software should be the same as the

settings you configure here.

4. Click **Save** to save and finish the settings.

Notes:

- A reboot is required for the settings to take effect.
- To lower the risk of information leakage, you are suggested to enable SNMP v3 instead of SNMP v1 or v2.

6.2.2 Configuring FTP Settings

Purpose:

You can configure the FTP server related information to enable the uploading of the captured pictures to the FTP server. The captured pictures can be triggered by events or a timing snapshot task.

Steps:

1. Enter the FTP Settings interface: **Configuration > Network > Advanced Settings > FTP**.

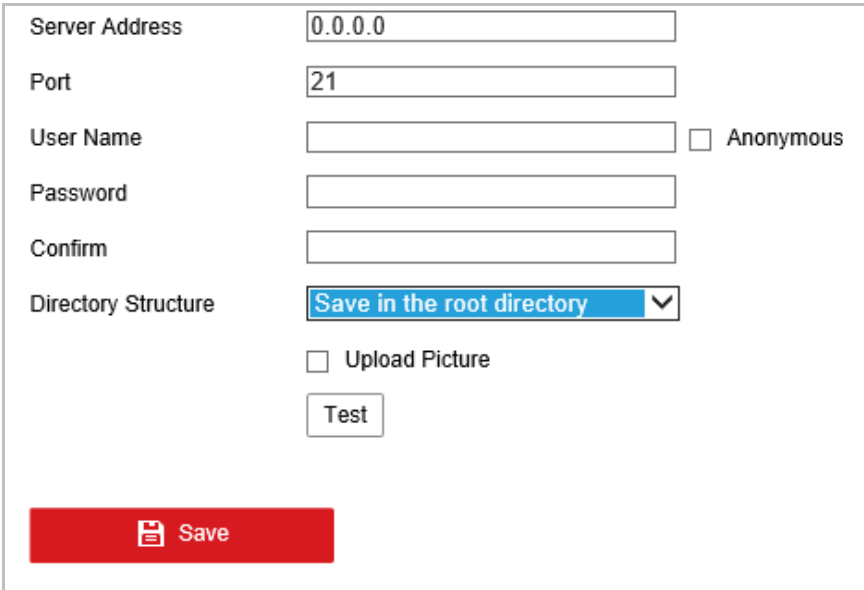

The screenshot shows the FTP Settings configuration interface. It includes the following fields and options:

- Server Address:** Text input field containing "0.0.0.0".
- Port:** Text input field containing "21".
- User Name:** Text input field.
- Anonymous:** Check box, currently unchecked.
- Password:** Text input field.
- Confirm:** Text input field.
- Directory Structure:** Dropdown menu with "Save in the root directory" selected.
- Upload Picture:** Check box, currently unchecked.
- Test:** Button.
- Save:** Red button with a floppy disk icon.

Figure 6-8 FTP Settings

2. Input the FTP address and port.
3. Configure the FTP settings; and the user name and password are required for the FTP server login.



For your privacy and to better protect your system against security risks, we strongly recommend the use of strong passwords for all functions and network devices. The password should be something of your own choosing (using a minimum of 8 characters, including at least three of the following categories: upper case letters, lower case letters, numbers and special characters) in order to increase the security of your product.

Proper configuration of all passwords and other security settings is the responsibility of the installer and/or end-user.

4. Set the directory structure and picture filing interval.

Directory: In the **Directory Structure** field, you can select the root directory, parent directory and child directory. When the parent directory is selected, you have the option to use the Device Name, Device Number or Device IP for the name of the directory; and when the Child Directory is selected, you can use the Camera Name or Camera No. as the name of the directory.

5. Check the Upload Picture checkbox to enable the function.

Upload Picture: To enable uploading the captured picture to the FTP server.

Anonymous Access to the FTP Server (in which case the user name and password won't be required.): Check the **Anonymous** checkbox to enable the anonymous access to the FTP server.

Note: The anonymous access function must be supported by the FTP server.

6. Click **Save** to save the settings.

6.2.3 Configuring Email Settings

Purpose:

The system can be configured to send an Email notification to all designated receivers if an alarm event is detected, e.g., motion detection event, video loss, video tampering, etc.

Before you start:

Please configure the DNS Server settings under **Configuration > Network > Basic Settings > TCP/IP** before using the Email function.

Steps:

1. Enter the TCP/IP Settings (**Configuration > Network > Basic Settings > TCP/IP**) to set the IPv4 Address, IPv4 Subnet Mask, IPv4 Default Gateway and the Preferred DNS Server.

Note: Please refer to *Section 6.1.1* for detailed information.

2. Enter the Email Settings interface: **Configuration > Network > Advanced Settings > Email**.

3. Configure the following settings:

Sender: The name of the email sender.

Sender's Address: The email address of the sender.

SMTP Server: IP address or host name (e.g., smtp.263xmail.com) of the SMTP Server.

SMTP Port: The SMTP port. The default TCP/IP port for SMTP is 25 (not secured). And the SSL SMTP port is 465.

Email Encryption: None, SSL, and TLS are selectable. When you select SSL or TLS and disable STARTTLS, e-mails will be sent after encrypted by SSL or TLS. The SMTP port should be set as 465 for this encryption method. When you select SSL or TLS and enable STARTTLS, emails will be sent after encrypted by STARTTLS, and the SMTP port should be set as 25.

Note: If you want to use STARTTLS, make sure that the protocol is supported by your e-mail server. If you check the Enable STARTTLS checkbox when the protocol is not supported by your e-mail sever, your e-mail will not be encrypted.

Attached Image: Check the checkbox of Attached Image if you want to send emails with attached alarm images.

Interval: The interval refers to the time between two actions of sending attached pictures.

Authentication (optional): If your email server requires authentication, check this checkbox to use authentication to log in to this server and input

the login user name and password.



For your privacy and to better protect your system against security risks, we strongly recommend the use of strong passwords for all functions and network devices. The password should be something of your own choosing (using a minimum of 8 characters, including at least three of the following categories: upper case letters, lower case letters, numbers and special characters) in order to increase the security of your product.

Proper configuration of all passwords and other security settings is the responsibility of the installer and/or end-user.

The **Receiver** table: Select the receiver to which the email is sent. Up to 3 receivers can be configured.

Receiver: The name of the user to be notified.

Receiver's Address: The email address of user to be notified.

Sender: test ✓

Sender's Address: test@gmail.com ✓

SMTP Server: []

SMTP Port: 25

E-mail Encryption: None ▼

Attached Image

Interval: 2 s ▼

Authentication

User Name: []

Password: []

Confirm: []

Receiver			
No.	Receiver	Receiver's Address	Test
1			Test
2			
3			

Figure 6-9 Email Settings

4. Click **Save** to save the settings.

6.2.4 Configuring HTTPS Settings

Purpose:

HTTPS provides authentication of the web site and its associated web server, which protects against Man-in-the-middle attacks. Perform the following steps to set the port number of https.

E.g., If you set the port number as 443 and the IP address is 192.168.1.64, you may access the device by inputting https://192.168.1.64:443 via the web browser.

Steps:

1. Enter the HTTPS settings interface. **Configuration > Network > Advanced Settings > HTTPS.**
2. Check the checkbox of Enable to enable the function.

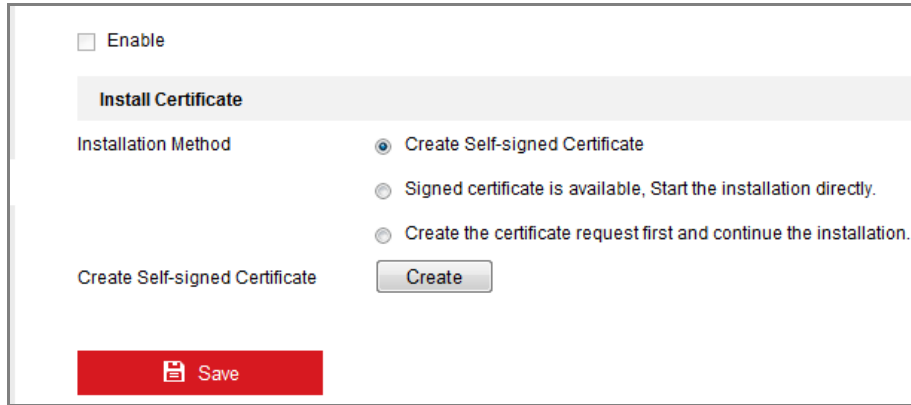

Figure 6-10 HTTPS Configuration Interface

3. Create the self-signed certificate or authorized certificate.

Create the self-signed certificate

- (1) Select **Create Self-signed Certificate** as the Installation Method.
- (2) Click **Create** button to enter the creation interface.

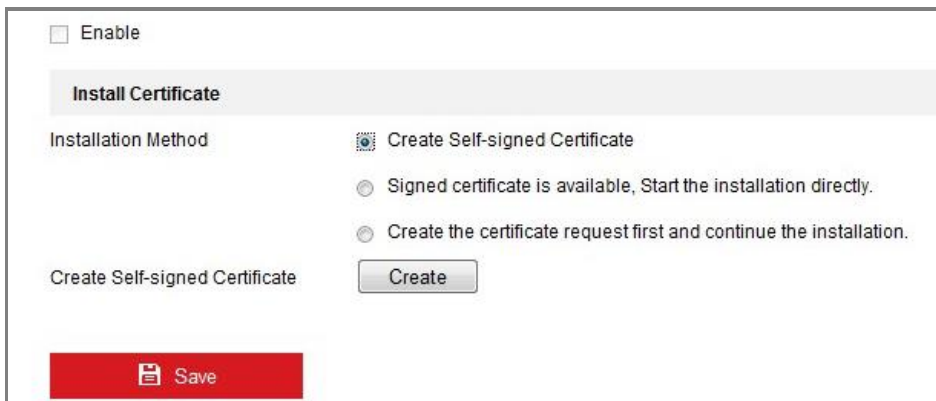

Figure 6-11 Create Self-signed Certificate

- (3) Enter the country, host name/IP, validity and other information.
- (4) Click **OK** to save the settings.

Note: If you already had a certificate installed, the Create Self-signed

Certificate is grayed out.

Create the authorized certificate

- (1) Select **Create the certificate request first and continue the installation** as the Installation Method.
 - (2) Click **Create** button to create the certificate request. Fill in the required information in the popup window.
 - (3) Download the certificate request and submit it to the trusted certificate authority for signature.
 - (4) After receiving the signed valid certificate, import the certificate to the device.
4. There will be the certificate information after your successfully creating and installing the certificate.

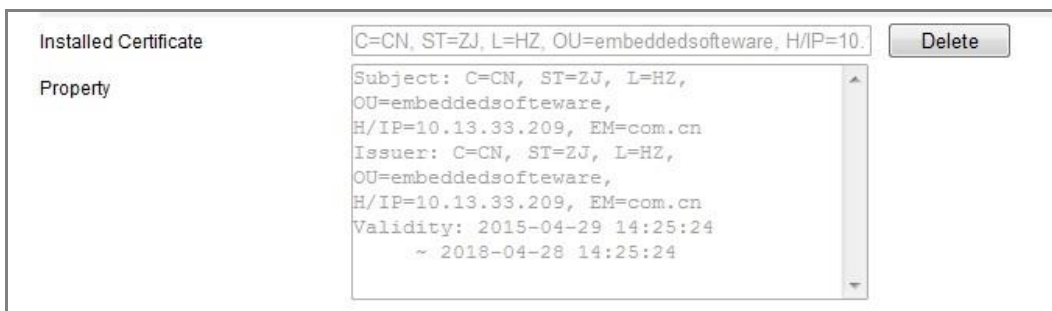

Figure 6-12 Installed Certificate

5. Click the **Save** button to save the settings.

6.2.5 Configuring QoS Settings

Purpose:

QoS (Quality of Service) can help solve the network delay and network

congestion by configuring the priority of data sending.

Steps:

1. Enter the QoS Settings interface: **Configuration > Network > Advanced Settings > QoS**



Video/Audio DSCP	<input type="text" value="0"/>
Event/Alarm DSCP	<input type="text" value="0"/>
Management DSCP	<input type="text" value="0"/>

Figure 6-13 QoS Settings

2. Configure the QoS settings, including Video/Audio DSCP, Event/Alarm DSCP and Management DSCP.

The valid value range of the DSCP is 0 to 63. The bigger the DSCP value is, the higher the priority is.

Note: DSCP refers to the Differentiated Service Code Point; and the DSCP value is used in the IP header to indicate the priority of the data.

3. Click **Save** to save the settings.

Note: A reboot is required for the settings to take effect.

6.2.6 Configuring 802.1X Settings

Purpose:

The IEEE 802.1X standard is supported by the network cameras, and when the feature is enabled, the camera data is secured and user authentication is

needed when connecting the camera to the network protected by the IEEE 802.1X.

Before you start:

The authentication server must be configured. Please apply and register a user name and password for 802.1X in the server.



For your privacy and to better protect your system against security risks, we strongly recommend the use of strong passwords for all functions and network devices. The password should be something of your own choosing (using a minimum of 8 characters, including at least three of the following categories: upper case letters, lower case letters, numbers and special characters) in order to increase the security of your product.

Proper configuration of all passwords and other security settings is the responsibility of the installer and/or end-user.

Steps:

1. Enter the 802.1X Settings interface, **Configuration > Network > Advanced Settings > 802.1X**

<input checked="" type="checkbox"/> Enable IEEE 802.1X	
Protocol	EAP-MD5
EAPOL version	1
User Name	
Password	
Confirm	

Figure 6-14 802.1X Settings

2. Check the **Enable IEEE 802.1X** checkbox to enable the feature.
3. Configure the 802.1X settings, including Protocol, EAPOL version, User Name, Password and Confirm.

Note: The **EAPOL version** must be identical with that of the router or the switch.

4. Enter the user name and password to access the server.
5. Click **Save** to finish the settings.

Note: A reboot is required for the settings to take effect.

Chapter 7 Video/Audio Settings

Purpose:

Follow the instructions below to configure the video setting, audio settings, ROI, and Display info. on Stream.

7.1 Configuring Video Settings

Steps:

1. Enter the Video Settings interface, Configuration > Video/Audio > Video

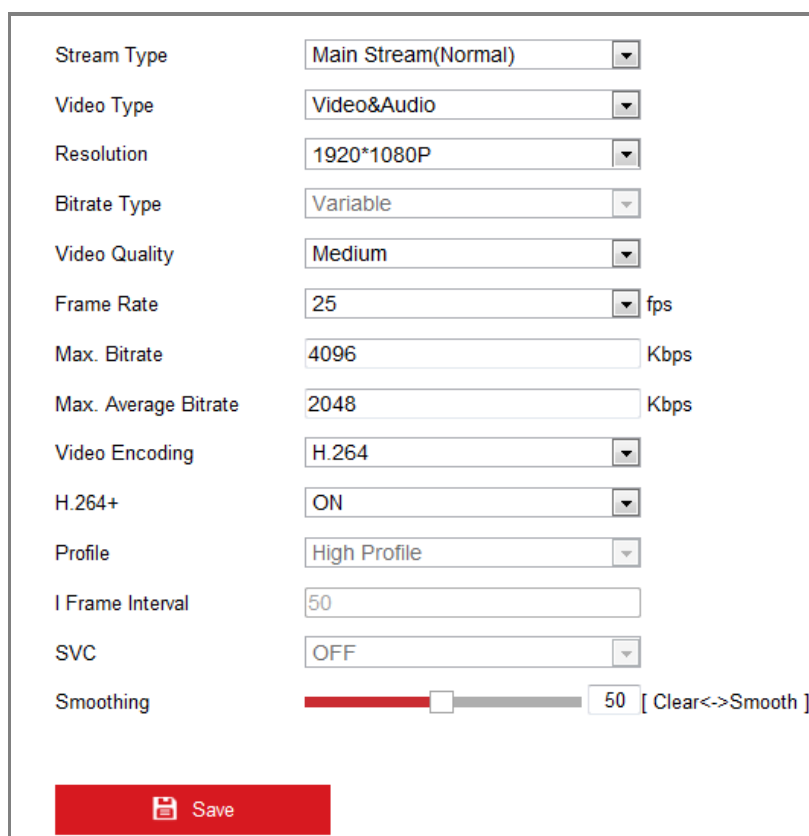

The screenshot displays the Video Settings interface with the following configurations:

Stream Type	Main Stream(Normal)
Video Type	Video&Audio
Resolution	1920*1080P
Bitrate Type	Variable
Video Quality	Medium
Frame Rate	25 fps
Max. Bitrate	4096 Kbps
Max. Average Bitrate	2048 Kbps
Video Encoding	H.264
H.264+	ON
Profile	High Profile
I Frame Interval	50
SVC	OFF
Smoothing	50 [Clear<->Smooth]

A red Save button is located at the bottom of the interface.

Figure 7-1 Video Settings

2. Select the Stream Type of the camera to main stream (normal), sub-stream or third stream.

Notes:

- For some models, to enable the third stream, go to System > Maintenance > System Service> Software and check the checkbox of Enable Third Stream to reboot the system and enable the third stream.
 - The main stream is usually for recording and live view with good bandwidth, and the sub-stream can be used for live view when the bandwidth is limited.
 - To enable the third stream, go to System>Maintenance>System Service> Software and check the checkbox of Enable Third Stream to reboot the system and enable the third stream.
3. You can customize the following parameters for the selected stream type.

Video Type:

Select the stream type to video stream, or video & audio composite stream.

The audio signal will be recorded only when the **Video Type** is **Video & Audio**.

Resolution:

Select the resolution of the video output.

Bitrate Type:

Select the bitrate type to constant or variable.

Video Quality:

When bitrate type is selected as Variable, 6 levels of video quality are selectable.

Frame Rate:

Set the frame rate. The frame rate is to describe the frequency at which the video stream is updated and it is measured by frames per second (fps). A higher frame rate is advantageous when there is movement in the video stream, as it maintains image quality throughout.

Max. Bitrate:

Set the max. bitrate from 32 to 16384 Kbps. The higher value corresponds to the higher video quality, but the better bandwidth is required.

Note: The maximum limit of the max. bitrate value varies according to different camera platforms. For certain cameras, the maximum limit is 8192 Kbps or 12288 Kbps.

Video Encoding:

If the Stream Type is set to main stream, H.264 and H.265 are selectable, and if the stream type is set to sub stream or third stream, H.264, MJPEG, and H.265 are selectable. H.265 is a new encoding technology. Compared with H.264, it reduces the transmission bitrate under the same resolution, frame rate and image quality.

Note: Selectable video encoding types may vary according to different camera modes.

H.264+ and H.265+:

- **H.264+:** If you set the main stream as the stream type, and H.264 as the video encoding, you can see H.264+ available. H.264+ is an improved

compression coding technology based on H.264. By enabling H.264+, users can estimate the HDD consumption by its maximum average bitrate. Compared to H.264, H.264+ reduces storage by up to 50% with the same maximum bitrate in most scenes.

- **H.265+:** If you set the main stream as the stream type, and H.265 as the video encoding, you can see H.265+ available. H.265+ is an improved compression coding technology based on H.265. By enabling H.265+, users can estimate the HDD consumption by its maximum average bitrate. Compared to H.265, H.265+ reduces storage by up to 50% with the same maximum bitrate in most scenes.

You need to reboot the camera if you want to turn on or turn off the H.264+/H.265+. If you switch from H.264+ to H.265+ directly, and vice versa, a reboot is not required by the system.

Notes:

- Upgrade your video player to the latest version if live view or playback does not work properly due to compatibility.
- The bitrate type must be variable if you want to use H.264+ or H.265+.
- With H.264+/H.265+ enabled, the parameters such as profile, I frame interval, video quality, and SVC are greyed out if the bitrate type is variable.
- With H.264+/H.265+ enabled, some functions are not supported. For those functions, corresponding interfaces will be hidden.

- H.264+/H.265+ can spontaneously adjust the bitrate distribution according to the requirements of the actual scene in order to realize the set maximum average bitrate in the long term. The camera needs at least 3 days to adapt to a fixed monitoring scene.

Max. Average Bitrate:

When you set a maximum bitrate, its corresponding recommended maximum average bitrate will be shown in the Max. Average Bitrate box. You can also set the maximum average bitrate manually from 32 Kbps to the value of the set maximum bitrate.

Profile:

Basic profile, Main Profile, and High Profile for coding are selectable.

I Frame Interval:

Set I Frame Interval from 1 to 400.

SVC:

Scalable Video Coding is an extension of the H.264/AVC standard. Select OFF/ON to disable/enable the SVC function. Select Auto and the device will automatically extract frames from the original video when the network bandwidth is insufficient.

Smoothing:

It refers to the smoothness of the stream. The higher value of the smoothing is, the better fluency of the stream will be, though, the video quality may not be so satisfactory. The lower value of the smoothing is, the

higher quality of the stream will be, though it may appear not fluent.

4. Click **Save** to save the settings.

Note:

The video parameters vary according to different camera models. Refer to the actual display page for camera functions.

7.2 Configuring Audio Settings

Steps:

1. Enter the Audio Settings interface: **Configuration > Video/Audio > Audio**.



Channel No.	Analog Camera1
Audio Encoding	G.711alaw
Audio Input	MicIn
Input Volume	50
Environmental Noise Filter	OFF

Save

Figure 7-2 Audio Settings

2. Configure the following settings.

Note: Audio settings vary according to different camera models.

Audio Encoding: G.722.1, G.711 ulaw, G.711alaw, G.726, MP2L2 and PCM are selectable. For MP2L2, the Sampling Rate and Audio Stream Bitrate are configurable. For PCM, the Sampling Rate can be set.

Audio Input: MicIn and LineIn are selectable for the connected microphone and pickup respectively.

Input Volume: 0-100 adjustable.

Environmental Noise Filter: Set it as OFF or ON. When the function is enabled, the noise in the environment can be filtered to some extent.

3. Click **Save** to save the settings.

7.3 Configuring ROI Encoding

Purpose:

ROI (Region of Interest) encoding helps to discriminate the ROI and background information in video compression, which means, the technology assigns more encoding resource to the region of interest, thus to increase the quality of the ROI whereas the background information is less focused.

Note: ROI function varies according to different camera models.

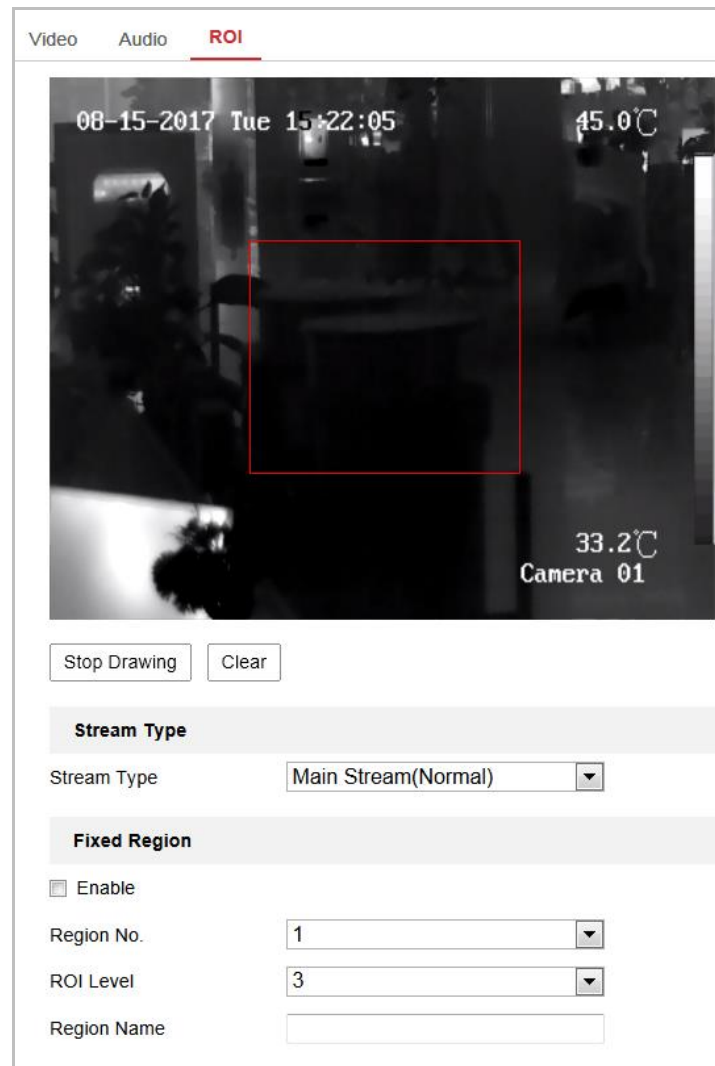

Figure 7-3 Region of Interest Settings

Steps:

1. Enter the ROI settings interface: **Configuration > Video/Audio > ROI**.
2. Select the Stream Type for ROI encoding.
3. Check the checkbox of **Enable** under Fixed Region item.
4. Set **Fixed Region** for ROI.
 - (1) Select the Region No. from the drop-down list.
 - (2) Check the **Enable** checkbox to enable ROI function for the chosen region.

- (3) Click **Drawing**. Click and drag the mouse on the view screen to draw a red rectangle as the ROI region. You can click **Clear** to cancel former drawing. Click **Stop Drawing** when you finish.
 - (4) Select the ROI level.
 - (5) Enter a region name for the chosen region.
 - (6) Click **Save** to save the settings of ROI settings for chosen fixed region.
 - (7) Repeat steps (1) to (6) to setup other fixed regions.
5. Set **Dynamic Region** for ROI.
- (1) Check the checkbox to enable **Face Tracking**.

Note: To enable face tracking function, the face detection function should be supported and enabled.

- (2) Select the ROI level.

6. Click **Save** to save the settings.

Note: ROI level means the image quality enhancing level. The larger the value is, the better the image quality would be.

7.4 metadata Settings

Before you start:

Go to **5.3.4 VCA Resource Type** to set the VCA (Video Content Analysis) resource type of your device.

Purpose:

To use the metadata for your third-party management platform, you should enable metadata first.

Steps:

1. Go to Configuration > Video/Audio > metadata Settings.
2. Check the VCA type for metadata enabling.
3. Click **Save** to save the settings.

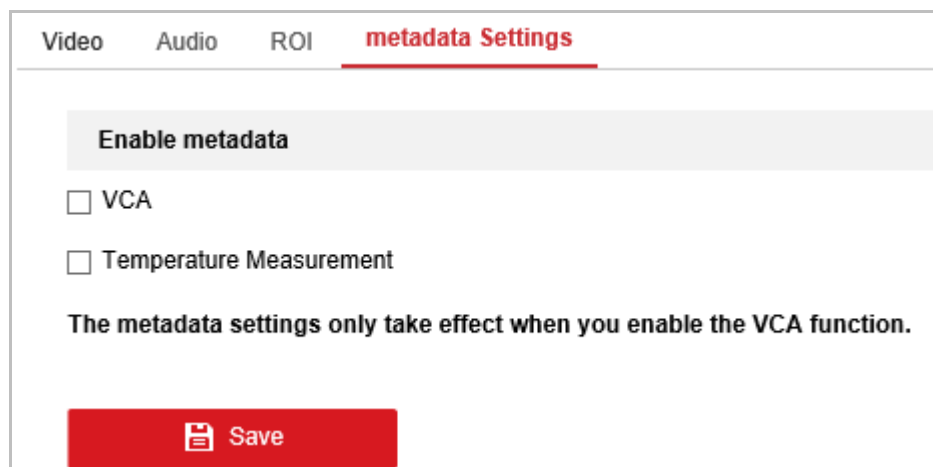

Figure 7-4 metadata Settings

Note: The metadata settings only takes effect when you enable the VCA function. E.g, when you enabled the Temperature Measurement metadata, it only works when you configured the temperature measurement rules and saved.

Chapter 8 Image Settings

Purpose:

Follow the instructions in this chapter to configure the image parameters, including display settings, OSD settings, privacy mask, and picture overlay.

8.1 Configuring Display Settings

Purpose:

Configure the image adjustment, image enhancement, video adjustment, and other parameters in display settings.

Note: The display parameters vary according to the different camera models.

Please refer to the actual interface for details.

Steps:

1. Enter the Display Settings interface, **Configuration > Image > Display Settings**.

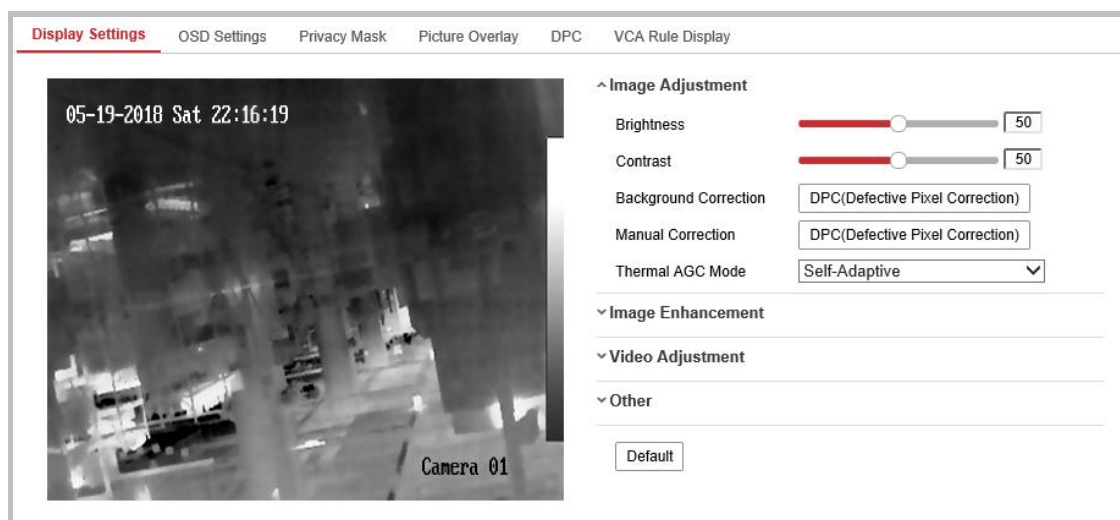

Figure 8-1 Display Settings

2. Set the image parameters of the camera.

Note: In order to guarantee the image quality in different illumination, it provides two sets of parameters for users to configure.

- **Image Adjustment**

Brightness describes bright of the image, which ranges from 1~100, and the default value is 50.

Contrast describes the contrast of the image, which ranges from 1~100, and the default value is 50.

Manual Background Correction: Fully cover the lens with an object (lens cover is recommended) and click the Manual Background Correction button, and then the camera adjusts the image according to the current environment.

Manual Shutter Correction: Click the Manual Shutter Correction button and then the camera adjusts the image according to the temperature of the camera itself.

Thermal AGC (optional): Choose the AGC mode according to different scenes to balance and improve the image quality.

- Histogram: Choose for scene with obvious WDR and high temperature difference, can improve image contrast and enhance image. E.g. the scene contains both indoor and outdoor scenes.

- Linear: Choose for scene with low temperature difference and the

target is not obvious, can improve image contrast and enhance image.

E.g. the bird in forest.

- Self-Adaptive: Choose AGC mode automatically according to current scene.

- **Image Enhancement**

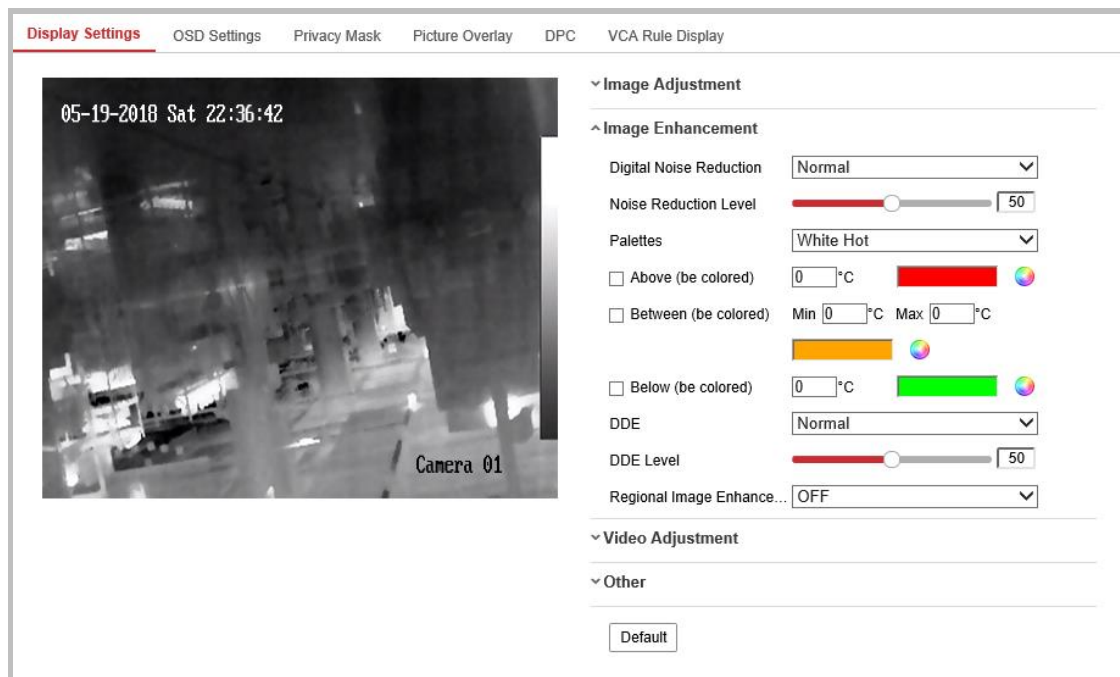

Figure 8-2 Image Enhancement

Digital Noise Reduction: DNR reduces the noise in the video stream.

OFF,

Normal and Expert are selectable. Set the DNR level from 0 to 100 in Normal Mode. Set the DNR level from both space DNR level [0-100] and time DNR level [0-100] in Expert Mode.

Palettes: The palettes allow you to select the desired colors.

In **White Hot** Mode, you can customize different colors for objects in

different temperature section.

- Check **Above (be colored)**, and set the temperature, the objects in the scene whose temperature is above the value will be colored in red (by default).
- Check **Between (be colored)**, and set the temperature, the objects in the scene whose temperature is between the two values will be colored in sienna (by default).
- Check **Below (be colored)**, and set the temperature, the objects in the scene whose temperature is below the value will be colored in green (by default).

DDE: The DDE (Digital Detail Enhancement) can adjust the details of the image. And you can set it to OFF or Normal mode. And DDE Level can be adjusted from 1 to 100 when in normal mode.

Brightness Sudden Change: (Only works with Behavior Analysis VCA Resource) When the brightness of target and the background is hugely different (the temperature difference of target and background is huge), the system reduces the difference for viewing.

Regional Image Enhancement (optional): You can select the desired area of image to show a red rectangle, in which the coding quality will be improved and the image will be more detailed and clear.

Select up, down, left, right, center_50%, center_70% to show a red rectangle, image will be enhanced in this area.

Select custom area to draw a red rectangle by yourself.

Select off to disable this function.

- **Video Adjustment**

Mirror: It mirrors the image so you can see it inversed. Left/Right, Up/Down, Center, and OFF are selectable.

Video Standard: 50 Hz and 60 Hz are selectable. Choose according to the different video standards; normally 50 Hz for PAL standard and 60 Hz for NTSC standard.

Capture Mode: It's the selectable video input mode to meet the different demands of field of view and resolution.

Digital Zoom: Select digital zoom as OFF, 2X, 4X or 8X to display live view in original size, 2X size digital zoomed, 4X size digital zoomed, or 8X size digital zoomed.

- **Other**

Local Output: Turn on or off the local output of device.

8.2 Configuring OSD Settings

Purpose:

You can customize the camera name, time/date format, display mode, and OSD size displayed on the live view.

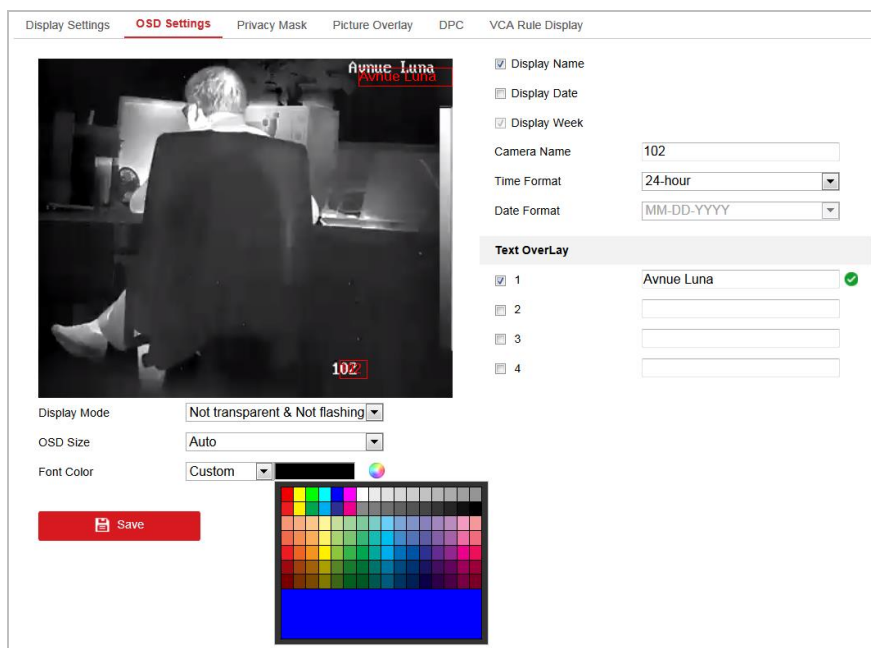

Figure 8-3 OSD Settings

Steps:

1. Enter the OSD Settings interface: **Configuration > Image > OSD Settings**.
2. Check the corresponding checkbox to select the display of camera name, date or week if required.
3. Edit the camera name in the text field of **Camera Name**.
4. Select from the drop-down list to set the time format and date format.
5. Select from the drop-down list to set the time format, date format, display mode, OSD size and OSD color.
6. Configure the text overlay settings.
 - (1) Check the checkbox in front of the textbox to enable the on-screen display.
 - (2) Input the characters in the textbox.

Note: Up to 8 text overlays are configurable.

7. Adjust the position and alignment of text frames.

Left align, right align and custom are selectable. If you select custom, you can use the mouse to click and drag text frames in the live view window to adjust their positions.

Note: The alignment adjustment is only applicable to Text Overlay items.

8. Click **Save** to save the settings.

8.3 Configuring Privacy Mask

Purpose:

Privacy mask enables you to cover certain areas on the live video to prevent certain spots in the surveillance area from being live viewed and recorded.

Steps:

1. Enter the Privacy Mask Settings interface: **Configuration > Image > Privacy Mask**.
2. Check the checkbox of **Enable Privacy Mask** to enable this function.
3. Click **Draw Area**.

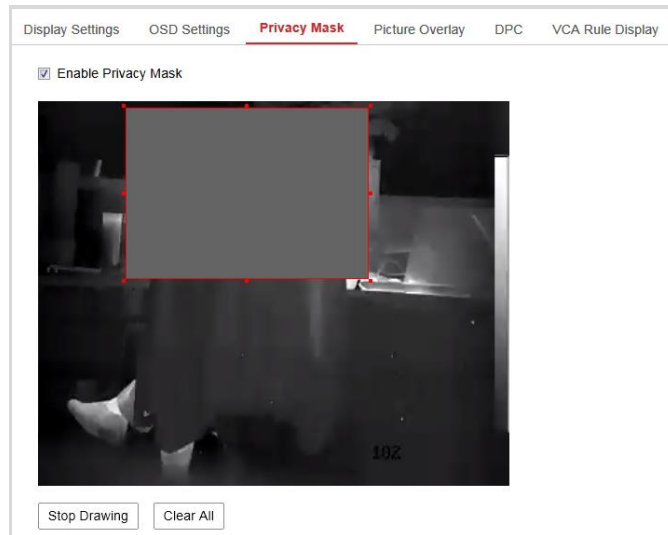

Figure 8-4 Privacy Mask Settings

4. Click and drag the mouse in the live video window to draw the mask area.

Note: You are allowed to draw up to 4 areas on the same image.

5. Click **Stop Drawing** to finish drawing or click **Clear All** to clear all of the areas you set without saving them.
6. Click **Save** to save the settings.

8.4 Configuring Picture Overlay

Purpose:

Picture overlay enables you to overlay a picture on the image. This function enables a certain enterprise or users to overlay their logo on the image.

Steps:

1. Enter the Picture Overlay Settings interface, **Configuration > Image > Picture Overlay**.



Figure 8-5 Picture Overlay

2. Click **Browse** to select a picture.
3. Click **Upload** to upload it.
4. Check **Enable Picture Overlay** checkbox to enable the function.
5. Set X Coordinate and Y Coordinate values adjust the picture position on the image. Adjust Picture Width and Picture Height to the desired size.
6. Click **Save** to save settings.

Note: The picture must be in RGB24 bmp format and the maximum picture size is 128*128.

8.5 Configuring DPC (Defective Pixel Correction)

Purpose:

DPC (Defective Pixel Correction) refers to the function that the camera can correct the defective pixels on the LCD which are not performing as expected.

Note: This function is only available to certain camera models.

Steps:



1. Enter the DPC Settings interface: **Configuration > Image > DPC**



Figure 8-6 Defective Pixel Correction

2. Select the mode. The following takes manual mode as an example.
3. Click on the image to select the defective pixel. The cursor on the image

will move to the clicked position. You can click  to slightly adjust the cursor position.

4. Click  to start correction.
5. Click  to cancel the correction, or click  to save.

8.6 Configuring VCA Rule Display

Purpose:

The VCA rule display refers to the function that you can customize the displayed overlay information of the VCA rule (e.g. temperature measurement) which includes the font size and line and frame color.

Note: This function is only available to certain camera models.

Steps:

1. Enter the VCA Rule Display Settings interface: **Configuration > Image > VCA Rule Display**
2. Select the desired font size and the line and frame color for the normal, pre-alarm and alarm.
3. Click **Save**.



Figure 8-7 VCA Rule Display

Chapter 9 Event Settings

This section explains how to configure the network camera to respond to alarm events, including basic event and smart event.

9.1 Basic Events

You can configure the basic events by following the instructions in this section, including motion detection, video tampering, alarm input, alarm output, and exception, etc. These events can trigger the linkage methods, such as Notify Surveillance Center, Send Email, Trigger Alarm Output, etc.

Note: Check the checkbox of Notify Surveillance Center if you want the alarm information to be pushed to PC or mobile client software as soon as the alarm is triggered.

9.1.1 Configuring Motion Detection

Purpose:

Motion detection detects the moving objects in the configured surveillance area, and a series of actions can be taken when the alarm is triggered.

In order to detect the moving objects accurately and reduce the false alarm rate, normal configuration and expert configuration are selectable for different motion detection environment.

Normal Configuration

Normal configuration adopts the same set of motion detection parameters in

the daytime and at night.

Tasks 1: Set the Motion Detection Area

Steps:

1. Enter the motion detection settings interface: **Configuration > Event > Basic Event > Motion Detection.**
2. Check the checkbox of **Enable Motion Detection.**
3. Check the checkbox of **Enable Dynamic Analysis for Motion** if you want to mark the detected objects with green rectangles.

Note: Select Disable for rules if you don't want the detected objected displayed with the green rectangles. Select disable rules from **Configuration > Local Configuration > Live View Parameters-rules.**



Figure 9-1 Enable Motion Detection

4. Click **Draw Area**. Click and drag the mouse on the live video to draw a motion detection area. Click **Stop Drawing** to finish drawing one area.
5. (Optional) Click **Clear All** to clear all of the areas.
6. (Optional) Move the slider to set the sensitivity of the detection.

Task 2: Set the Arming Schedule for Motion Detection



Figure 9-2 Arming Schedule

Steps:

1. Click **Arming Schedule** to edit the arming schedule.
2. Click on the time bar and drag the mouse to select the time period.

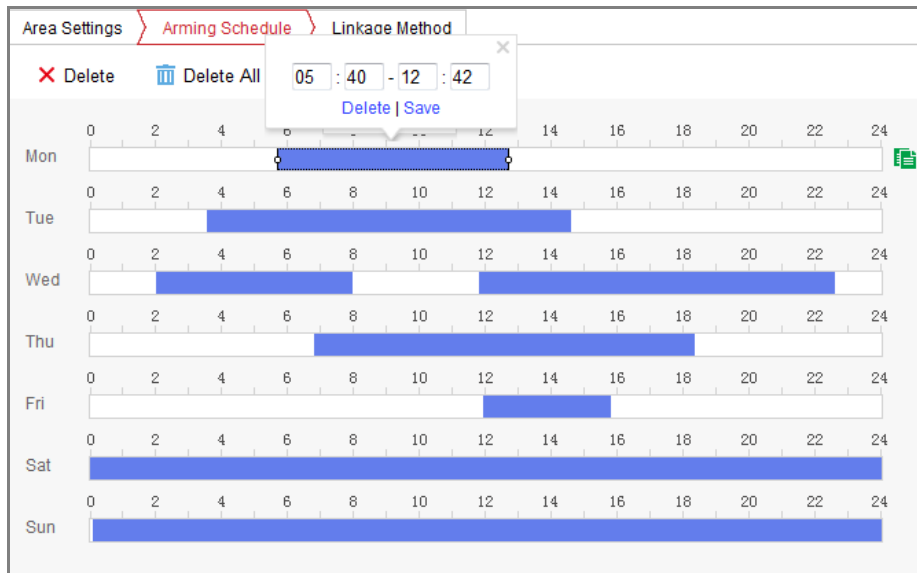

Figure 9-3 Arming Schedule

Note: Click on the selected time period, you can adjust the time period to the desired time by either moving the time bar or input the exact time

period.

3. (Optional) Click Delete to delete the current arming schedule, or click Save to save the settings.
4. Move the mouse to the end of each day, a copy dialogue box pops up, and you can copy the current settings to other days.
5. Click **Save** to save the settings.

Note: The time of each period can't be overlapped. Up to 8 periods can be configured for each day.

Task 3: Set the Linkage Method for Motion Detection

Check the checkbox to select the linkage method. Audible Warning, Send Email, Notify Surveillance Center, Upload to FTP/Memory Card/NAS, Trigger Channel and Trigger Alarm Output are selectable. You can specify the linkage method when an event occurs.

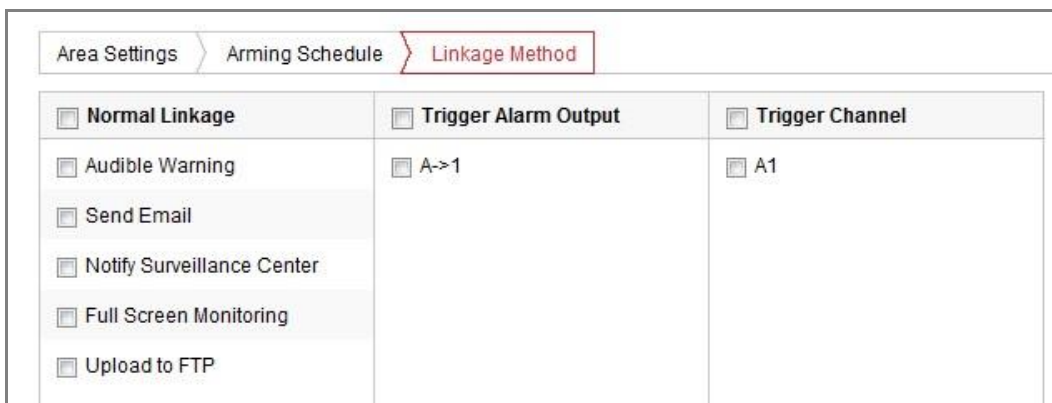

<input type="checkbox"/> Normal Linkage	<input type="checkbox"/> Trigger Alarm Output	<input type="checkbox"/> Trigger Channel
<input type="checkbox"/> Audible Warning	<input type="checkbox"/> A->1	<input type="checkbox"/> A1
<input type="checkbox"/> Send Email		
<input type="checkbox"/> Notify Surveillance Center		
<input type="checkbox"/> Full Screen Monitoring		
<input type="checkbox"/> Upload to FTP		

Figure 9-4 Linkage Method

Note: The linkage methods vary according to the different camera models.

Audible Warning

Trigger the audible warning locally. And it only supported by the device that

have the audio output.

Notify Surveillance Center

Send an exception or alarm signal to remote management software when an event occurs.

Send Email

Send an email with alarm information to a user or users when an event occurs.

Note: To send the Email when an event occurs, please refer to 6.2.3 to complete Email setup in advance.

Upload to FTP/Memory Card/NAS

Capture the image when an alarm is triggered and upload the picture to a FTP server.

Notes:

- Set the FTP address and the remote FTP server first. Refer to 6.2.2 for detailed information.
- Go to **Configuration > Storage > Schedule Settings > Capture > Capture Parameters** page, enable the event-triggered snapshot, and set the capture interval and capture number.
- The captured image can also be uploaded to the available SD card or network disk.

Trigger Channel

The video will be recorded when the motion is detected. You have to set

the recording schedule to realize this function. Please refer to 10.1 for detailed information.

Trigger Alarm Output

Trigger one or more external alarm outputs when an event occurs.

Note: To trigger an alarm output when an event occurs, please refer to *Section 9.1.4 Configuring Alarm Output* to set the related parameters.

Expert Configuration

Expert mode is mainly used to configure the sensitivity and proportion of object on each area for different day/night switch.

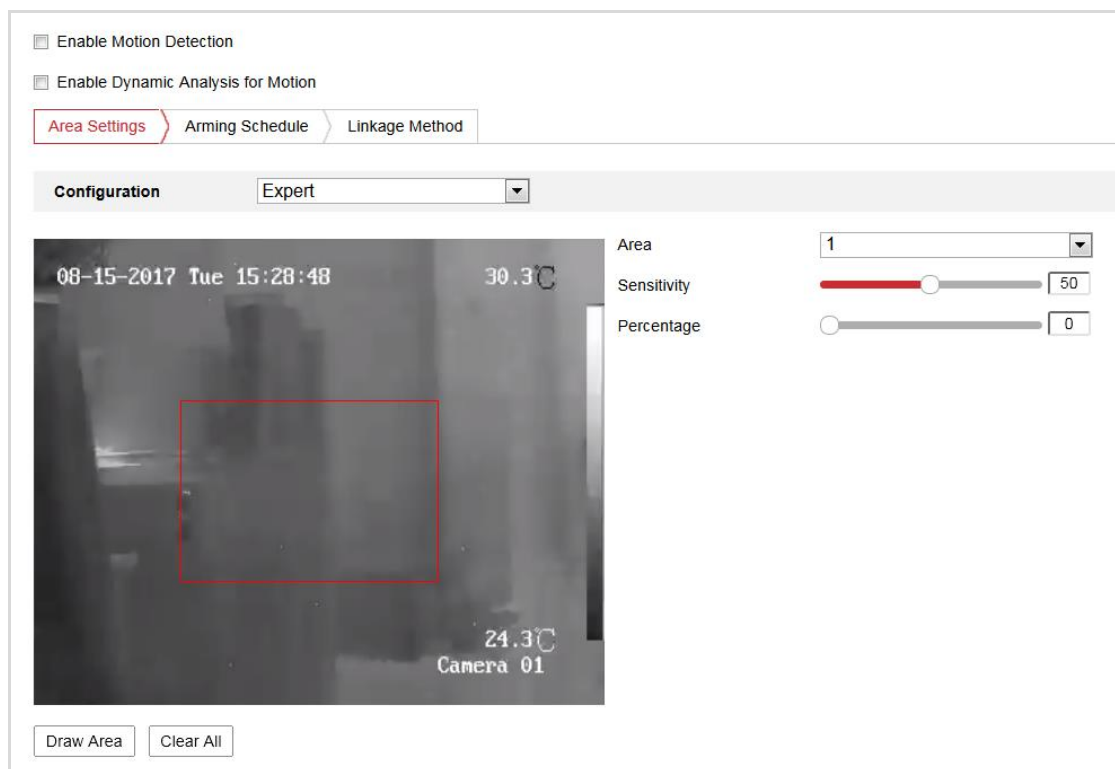

Figure 9-5 Expert Mode of Motion Detection

Day/Night Switch OFF

Steps:

1. Draw the detection area as in the normal configuration mode. Up to 8

areas are supported.

2. Select **OFF** for **Switch Day and Night Settings**.
3. Select the area by clicking the area No.
4. Slide the cursor to adjust the sensitivity and proportion of object on the area for the selected area.
5. Set the arming schedule and linkage method as in the normal configuration mode.
6. Click **Save** to save the settings.

Day/Night Auto-Switch

Steps:

1. Draw the detection area as in the normal configuration mode. Up to 8 areas are supported.
2. Select **Auto-Switch** for **Switch Day and Night Settings**.
3. Select the area by clicking the area No.
4. Slide the cursor to adjust the sensitivity and proportion of object on the area for the selected area in the daytime.
5. Slide the cursor to adjust the sensitivity and proportion of object on the area for the selected area at night.
6. Set the arming schedule and linkage method as in the normal configuration mode.
7. Click **Save** to save the settings.

Day/Night Scheduled-Switch

Steps:

1. Draw the detection area as in the normal configuration mode. Up to 8 areas are supported.
2. Select **Scheduled-Switch** for **Switch Day and Night Settings**.



Switch Day and Night Set...	Scheduled-Switch
Start Time	06:00:00
End Time	18:00:00

Figure 9-6 Day/Night Scheduled-Switch

3. Select the start time and the end time for the switch timing.
4. Select the area by clicking the area No..
5. Slide the cursor to adjust the sensitivity and proportion of object on the area for the selected area in the daytime.
6. Slide the cursor to adjust the sensitivity and proportion of object on the area for the selected area at night.
7. Set the arming schedule and linkage method as in the normal configuration mode.
8. Click **Save** to save the settings.

9.1.2 Configuring Video Tampering Alarm

Purpose:

You can configure the camera to trigger the alarm when the lens is covered and take certain alarm response actions.

Steps:

1. Enter the video tampering Settings interface, **Configuration > Event > Basic Event > Video Tampering**.

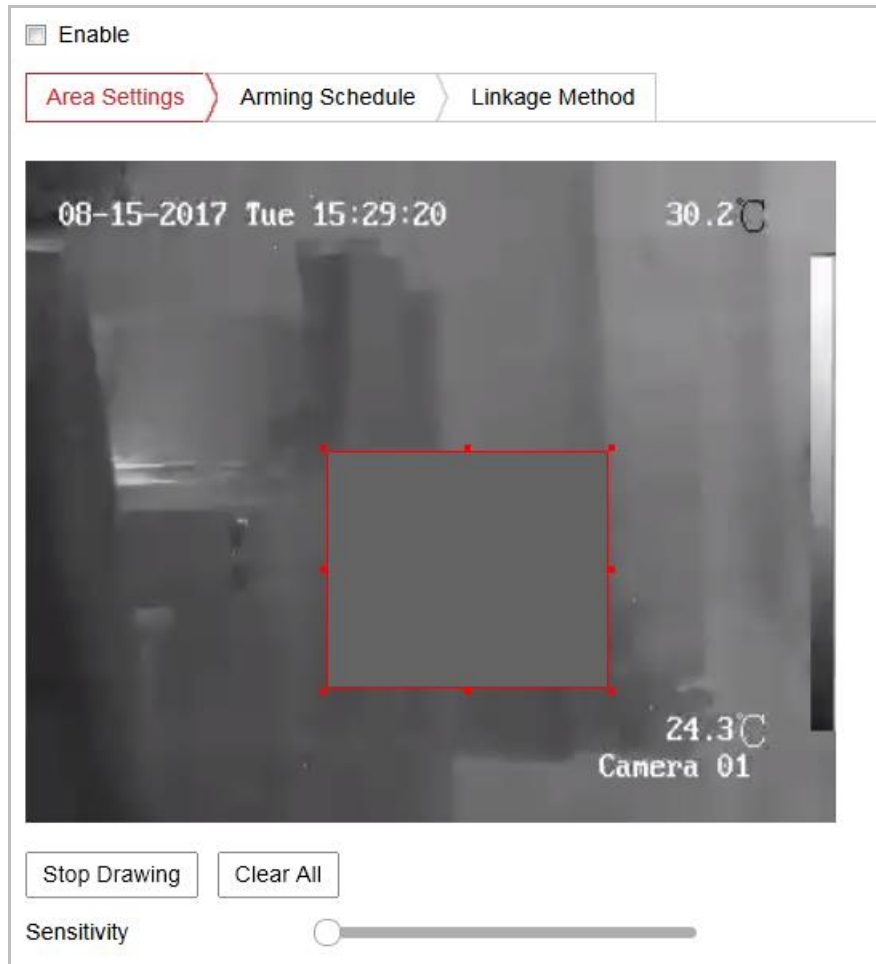

Figure 9-7 Video Tampering Alarm

2. Check **Enable Video Tampering** checkbox to enable the video tampering detection.
3. Set the video tampering area. Refer to *Task 1: Set the Motion Detection Area* in *Section 9.1.1*.
4. Click **Edit** to edit the arming schedule for video tampering. The arming schedule configuration is the same as the setting of the arming schedule

for motion detection. Refer to *Task 2: Set the Arming Schedule for Motion Detection* in Section 9.1.1.

5. Check the checkbox to select the linkage method taken for the video tampering. Audible warning, notify surveillance center, send email and trigger alarm output are selectable. Please refer to *Task 3: Set the Linkage Method for Motion Detection* in Section 9.1.1.
6. Click **Save** to save the settings.

9.1.3 Configuring Alarm Input

Steps:

1. Enter the Alarm Input Settings interface: **Configuration > Event > Basic Event > Alarm Input**.
2. Choose the alarm input No. and the Alarm Type. The alarm type can be NO (Normally Open) and NC (Normally Closed). Edit the name to set a name for the alarm input (optional).

Motion Detection Video Tampering **Alarm Input** Alarm Output Exception

Alarm Input No. IP Address

Alarm Type Alarm Name

Enable Alarm Input Handling

Arming Schedule Linkage Method

Day	0	2	4	6	8	10	12	14	16	18	20	22	24
Mon													
Tue													
Wed													
Thu													
Fri													
Sat													
Sun													

Figure 9-8 Alarm Input Settings

3. Click **Arming Schedule** to set the arming schedule for the alarm input. Refer to *Task 2: Set the Arming Schedule for Motion Detection* in Section 9.1.1.
4. Click **Linkage Method** and check the checkbox to select the linkage method taken for the alarm input. Refer to *Task 3: Set the Linkage Method for Motion Detection* in Section 9.1.1.
5. You can copy your settings to other alarm inputs.
6. Click **Save** to save the settings.

9.1.4 Configuring Alarm Output

Motion Detection Video Tampering Alarm Input **Alarm Output** Exception

Alarm Output No. IP Address

Delay Alarm Name

Alarm Status (cannot copy)

Arming Schedule

Mon	0	2	4	6	8	10	12	14	16	18	20	22	24
Tue	0	2	4	6	8	10	12	14	16	18	20	22	24
Wed	0	2	4	6	8	10	12	14	16	18	20	22	24
Thu	0	2	4	6	8	10	12	14	16	18	20	22	24
Fri	0	2	4	6	8	10	12	14	16	18	20	22	24
Sat	0	2	4	6	8	10	12	14	16	18	20	22	24
Sun	0	2	4	6	8	10	12	14	16	18	20	22	24

Figure 9-9 Alarm Output Settings

Steps:

1. Enter the Alarm Output Settings interface: **Configuration > Event > Basic Event > Alarm Output**.
2. Select one alarm output channel in the **Alarm Output** drop-down list. You can also set a name for the alarm output (optional).
3. The Delay time can be set to 5sec, 10sec, 30sec, 1min, 2min, 5min, 10min or Manual. The delay time refers to the time duration that the alarm output remains in effect after alarm occurs.
4. Click **Arming Schedule** to enter the Edit Schedule Time interface. The time schedule configuration is the same as the settings of the arming schedule

for motion detection Refer to *Task 2: Set the Arming Schedule for Motion Detection* in *Section 9.1.1*.

5. You can copy the settings to other alarm outputs.
6. Click **Save** to save the settings.

9.1.5 Handling Exception

The exception type can be HDD full, HDD error, network disconnected, IP address conflicted and illegal login to the cameras.

Steps:

1. Enter the Exception Settings interface: **Configuration > Event > Basic Event > Exception**.
2. Check the checkbox to set the actions taken for the Exception alarm. Refer to *Task 3: Set the Linkage Method for Motion Detection* in 9.1.1 for detailed steps.

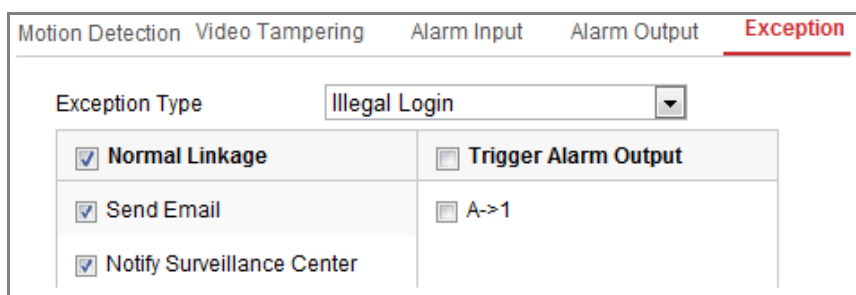

Motion Detection	Video Tampering	Alarm Input	Alarm Output	Exception
Exception Type: Illegal Login				
<input checked="" type="checkbox"/> Normal Linkage	<input type="checkbox"/> Trigger Alarm Output			
<input checked="" type="checkbox"/> Send Email	<input type="checkbox"/> A->1			
<input checked="" type="checkbox"/> Notify Surveillance Center				

Figure 9-10 Exception Settings

3. Click **Save** to save the settings.

9.2 Smart Events

You can configure the smart events by following the instructions in this section, including audio exception detection, scene change detection, dynamic fire source detection, and fire source detection shield, etc.

9.2.1 Configuring Audio Exception Detection

Purpose:

Audio exception detection function detects the abnormal sounds in the surveillance scene, such as the sudden increase/decrease of the sound intensity, and some certain actions can be taken when the alarm is triggered.

Note: Audio exception detection function varies according to different camera models.

Steps:

1. Enter the Audio Exception Detection settings interface, **Configuration > Event > Smart Event > Audio Exception Detection**.

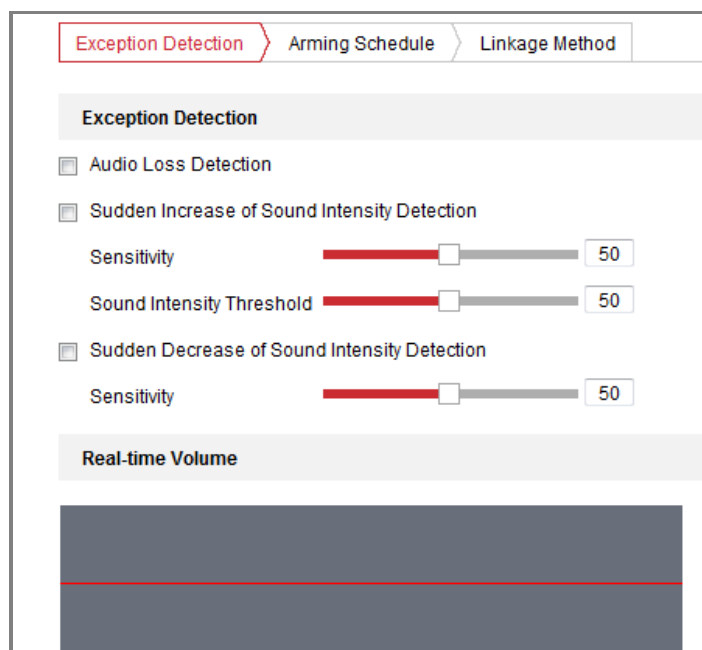

Figure 9-11 Audio Exception Detection

2. Check the checkbox of **Audio Loss Exception** to enable the audio loss detection function.
3. Check the checkbox of **Sudden Increase of Sound Intensity Detection** to detect the sound step rise in the surveillance scene. You can set the detection sensitivity and threshold for sound step rise.
4. Check the checkbox of **Sudden Decrease of Sound Intensity Detection** to detect the sound step drop in the surveillance scene. You can set the detection sensitivity and threshold for sound step drop.

Notes:

Sensitivity: Range [1-100], the smaller the value is, the more severe the change should be to trigger the detection.

Sound Intensity Threshold: Range [1-100], it can filter the sound in the environment, the louder the environment sound, the higher the value

should be. You can adjust it according to the real environment.

You can view the real-time volume of the sound on the interface.

5. Click **Arming Schedule** to set the arming schedule. Refer to *Task 2 Set the Arming Schedule for Motion Detection* in Section 9.1.1 for detailed steps.
6. Click **Linkage Method** and select the linkage methods for audio exception, including Notify Surveillance Center, Send Email, Upload to FTP/Memory Card/NAS, Trigger Channel for recording and Trigger Alarm Output.
7. Click **Save** to save the settings.

9.2.2 Configuring Scene Change Detection

Purpose:

Scene change detection function detects the change of surveillance environment affected by the external factors, such as the intentional rotation of the camera. Some certain actions can be taken when the alarm is triggered.

Note: Scene change detection function varies according to different camera models.

Steps:

1. Enter the Scene Change Detection settings interface, **Configuration > Event > Smart Event > Scene Change Detection**.

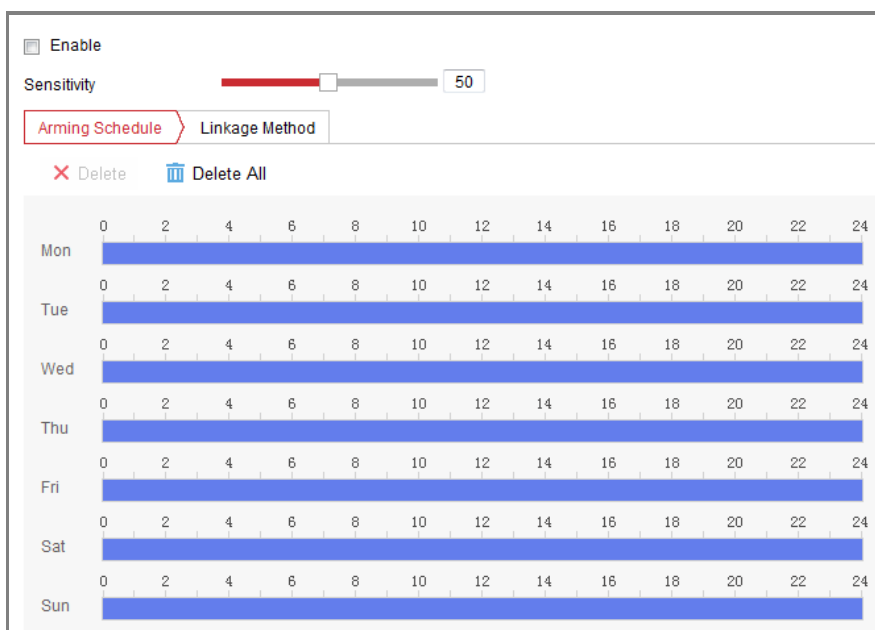

Figure 9-12 Scene Change Detection

2. Check the checkbox of **Enable** to enable the function.
3. Click-and-drag the slider to set the detection sensitivity. The sensitivity value ranges from 1 to 100, and the higher the value is, the more easily the change of scene can trigger the alarm.
4. Click **Arming Schedule** to set the arming schedule. Refer to *Task 2 Set the Arming Schedule for Motion Detection* in *Section 9.1.1* for detailed steps.
5. Click **Linkage Method** to select the linkage methods for scene change, including Notify Surveillance Center, Send Email, Upload to FTP/Memory Card/NAS, Trigger Channel and Trigger Alarm Output.
6. Click **Save** to save the settings.

9.2.3 Configuring Dynamic Fire Source Detection

Purpose:

When you enable this function and fire source is detected, the alarm actions will be triggered.

Note: This function varies according to different camera models

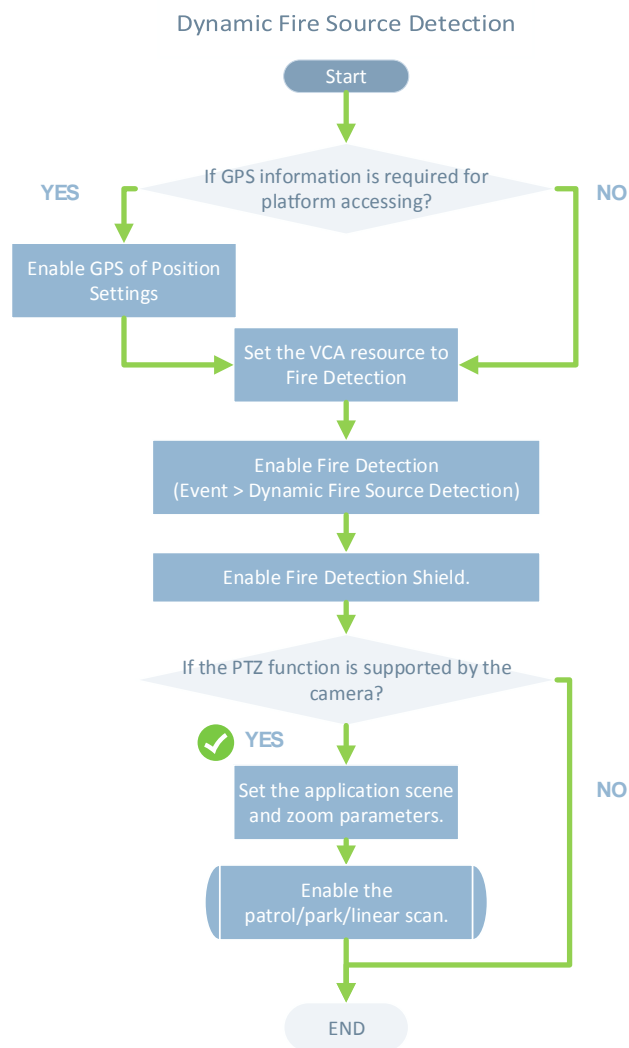

Steps:

1. Enter the Dynamic Fire Source Detection setting interface: **Configuration > Event > Smart Event > Dynamic Fire Source Detection**
2. Check the checkbox of **Enable Dynamic Fire Source Detection** to enable the function.

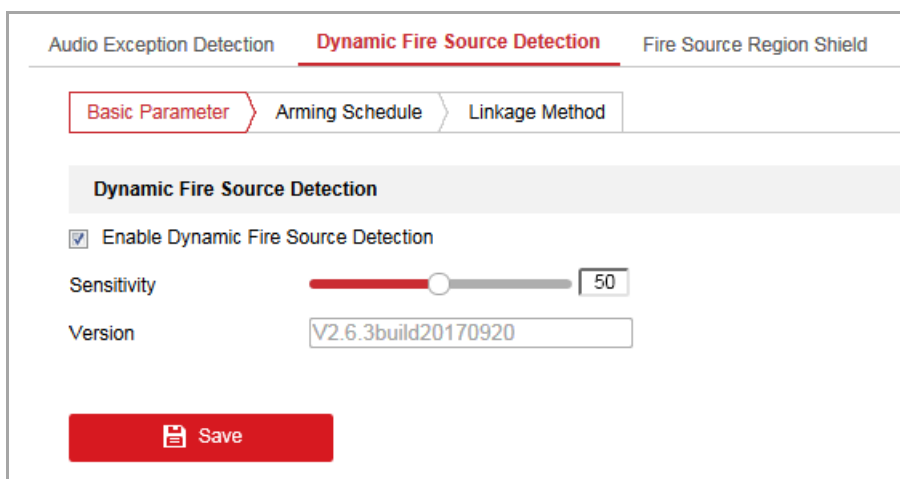

Figure 9-13 Configuring Dynamic Fire Source Detection

3. Check the checkbox of **Display Fire Source Frame on Stream** to display a red frame around the fire source on stream when fire occurs. (Optional)
4. You can drag the slider to adjust the sensitivity degree of dynamic fire source detection from 1 to 10. The bigger the number is, the more sensitive the detecting would be.
5. Check the checkbox to select the linkage method taken for the alarm input. Please refer to *Task 3: Set the Alarm Actions for Motion Detection* in Section 9.1.1. In the field of Other Linkage, you can check the checkbox to enable the alarm output (The alarm output number varies depending on device ability).
6. Click **Save** to save the settings.

9.2.4 Configuring Fire Source Detection Shield

Purpose:

Fire Source Shield enables you to shield certain areas from being detected in

fire source detection.

Note: This function varies according to different camera models.

Steps:

1. Enter **Configuration > Event > Smart Event > Fire Source Detection Shield**.
2. Check the checkbox to enable the fire detection.
3. Click **Draw Area**; click and drag the mouse in the live video window to draw the area.



Figure 9-14 Fire Source Detection Shield

4. You can drag the corners of the red rectangle area to change its shape and size.
5. Click **Stop Drawing** to finish drawing or click **Clear All** to clear all of the areas you set without saving them.

6. Set the shield area transparency to semitransparent, no-transparent, or transparent.
7. Click **Add** to save the fire source detection shield, and it will be listed in the Fire Source Detection Shield List area; you can select a region and click **Delete** to delete it from the list; you can also define the color of the regions.
8. Check the checkbox of **Enable Fire Source Detection Shield** to enable this function.

Note: You are allowed to draw up to 24 areas on the same image.

9.3 VCA Configuration

9.3.1 Configuring Overlay & Capture

Purpose:

You can enable to display the VCA information on stream or target information on alarm picture and set the snapshot quality and resolution.

Steps:

1. Enter **Configuration > VCA > Overlay & Capture**.
2. Check the desired checkbox of display settings and select the snapshot quality and resolution.

Overlay & Capture

Display on Stream

- Display VCA Info. on Stream
- Display Trajectory

Display on Picture

- Display Target Info. on Alarm Picture
- Display Rule Info. on Alarm Picture

Snapshot Settings

- Upload JPEG Image to Center

Picture Quality

 Save

Figure 9-15 Overlay & Capture

Display information includes the display on picture and display on stream.

Display VCA info. on Stream: The green frames will be displayed on the target if in a live view or playback.

Display Trajectory: Check to enable the trajectory display. The target's moving trajectory will be shown in the live view.

Display Target info. on Alarm Picture: There will be a frame on the target on the uploaded alarm picture if the checkbox is checked.

Display Rule info. on Alarm Picture: The captured target and the configured area will be framed on the alarm picture.

Note: Make sure the rules are enabled in your local settings. Go to

Configuration > Local Configuration > Rules to enable it.

Snapshot Setting: You can set the quality and resolution for the captured picture.

Upload JPEG Image to Center: Check the checkbox to upload the captured image to the surveillance center when a VCA alarm occurs.

Picture Quality: High, Medium and Low are selectable.

Picture Resolution: CIF, 4CIF, 720P, and 1080P are selectable.

9.3.2 Behavior Analysis Configuration

Perform the following steps to three-dimensionally measure and quantize the image from the camera, and then calculate the size of every target. The VCA detection will be more accurate if the camera calibration is configured.

Before you start:

Make sure that we have known the actual height of the person in the scene.

Steps:

1. Configure the display information and snapshot settings.
2. Set the **Auto Calibration**.
 - a) Check the checkbox of **Camera Calibration** to enable this function.
 - b) Make sure only one person appears in the live view, and input the person's height in the Target Height text field.
 - c) Click  to start auto calibration.

Notes:

Make sure there is no moving objects in the view except for the person.

The auto calibration starts when the person is totally seen in the camera's view, and ends when the person is in the endpoint (The endpoint-to-camera distance(m) equals 4 times the lens focal length(mm)). E.g, for 7mm lens, the recommended endpoint is 28m (7*4).

Once auto calibration started, the person should start to walk in a zigzag course. Make sure the walking route covers the left, middle, right of image.

The auto calibration duration should be no shorter than 10s, and no longer than 10min. Walking in a double Z zigzag is theoretically enough.

For leave/tree interference in the live view, shield settings is recommended.

3. When the person exits, Click to stop auto calibration.

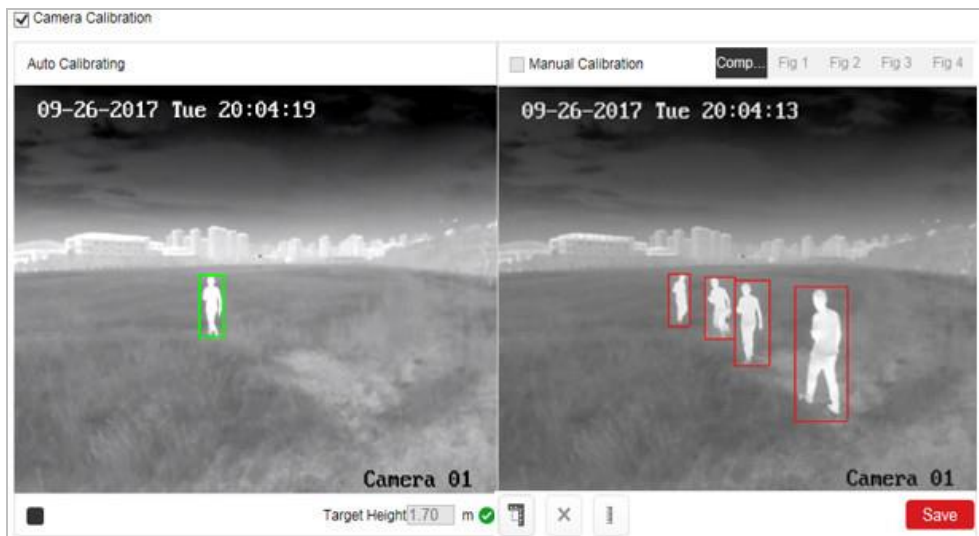

Figure 9-16 Auto Calibration

Verification:

1. Click the **Enable Verification**  button.

Notes:

Verify not only person, but also other objects appeared in the view. Such as car, street lamp, etc.

The verifying result value is only the height of the line. The horizontal width is not measured.



2. Click the **Vertical Verify**  button, and drag a vertical line in the view.
3. Click the **Calibration**  button to calculate the length.
4. Compare the calculated line length to the actual length to verify the calibration settings.



Figure 9-17 Calibration Verification

Note:

If the Auto Calibration failed, or the verified result turns bad, click Fig 1 to Fig 4 to examine whether they are valid person/object in the figures or not. If so, refer to the Manual Calibration.

4. (Optional) Set the **Manual Calibration**.

- a) Check **Manual Calibration**.
- b) Select Fig 1.



Figure 9-18 Manual Calibration

- c) Click  and drag the vertical line until it fits the target.
- d) Input the actual length of the calibration line.

- e) (Optional) you can click × to delete the calibration line.
- f) When the ✓ appears, select Fig 2 to 4 and repeat step 3.
- g) Click **Save**.

Notes:

Separate 4 vertical lines at the left, middle and right of the image respectively.
Separate 4 vertical lines in the optical-axis direction at the close site, middle and far site respectively.
In the four figures, the calibrated object doesn't need to be the same. Select a proper object in each figure.
If manual calibration's result is incorrect, reset the target to recalibrate.

Verification:

Refer to the verification procedure of **Auto Calibration**.

9.3.3 Configuring Shield Region

The shield region allows you to set the specific region in which the behavior analysis will not function. Up to 4 shield regions are supported.

Steps:

1. Enter **Configuration > VCA > Shield Region**.
2. Click **Shield Region** tab to enter the shield region configuration interface.
3. Click the hexagons sign  to draw shield area by left click end-points in the live view window, and right click to finish the area drawing.

Notes:

Polygon area with up to 10 sides is supported.

Click  to delete the drawn areas.

If live view is stopped, there is no way to draw the shield regions.

4. Click **Save** to save the settings.

9.3.4 Configuring Rule

The behavior analysis supports a series of behaviors, including line crossing detection, intrusion, region entrance, and region exiting, etc.

Note: Please refer to each chapter for detailed information of each behavior.

Steps:

1. Enter **Configuration > VCA > Rule**.
2. Click **Rule** Tab to enter the rule configuration interface.
3. Check the checkbox of the single rule to enable the rule for behavior analysis.
4. Select the rule type, set the filter type, and then draw the line/area on the live video for the single rule.

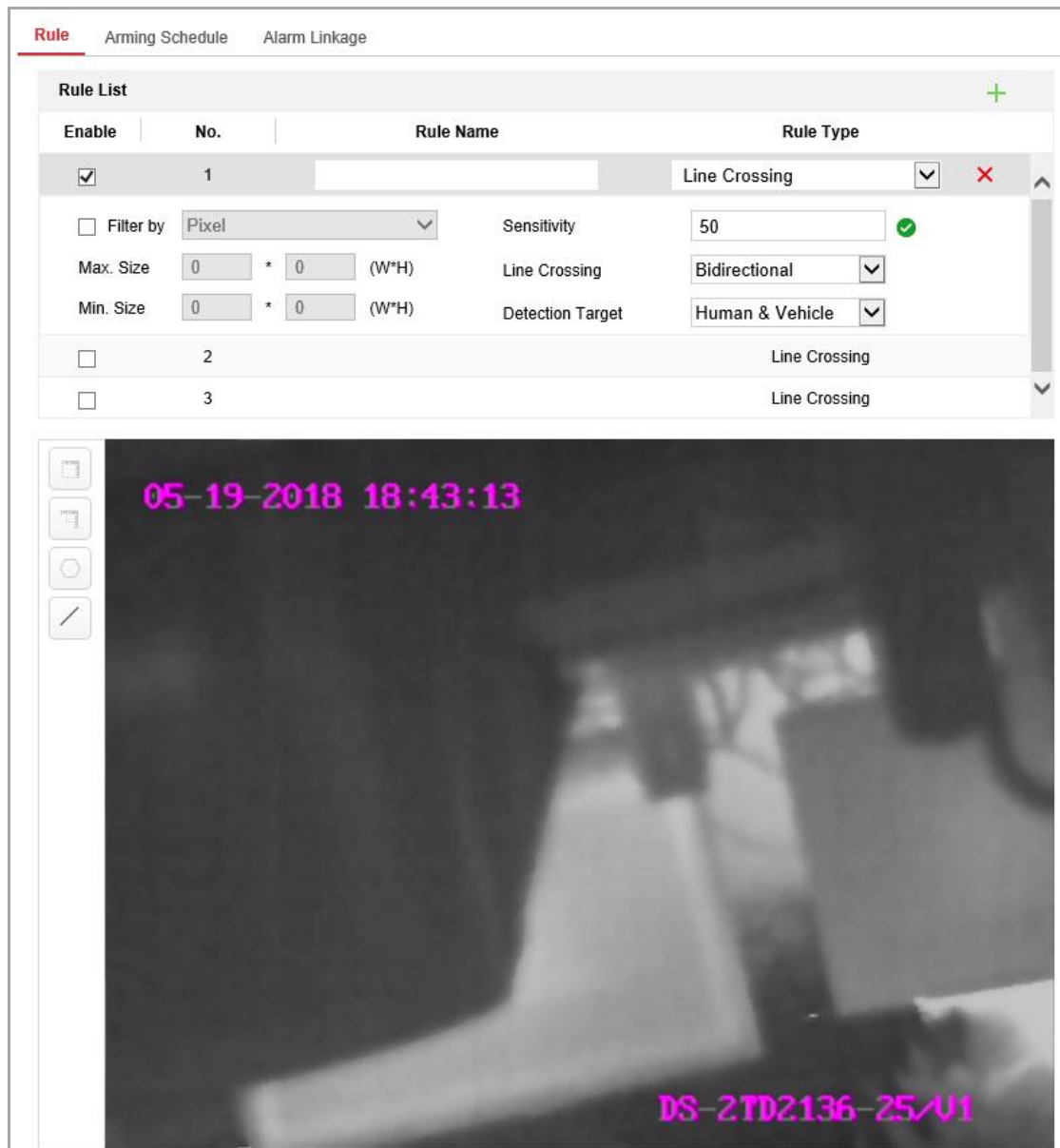

Figure 9-19 Configure the Rule

Example:

- Select the rule type of Line Crossing.
- Set the filter type to Actual Size when the camera calibration is configured.
- Set the sensitivity. The higher the value is, the more likely to trigger the alarm.
- Input the width and height of the Max. Size and Min. Size. Only the target whose size is between the Max. Size and Min. Size value will trigger the alarm.

- e) Set the Detection Target as Human, Vehicle, or Human & Vehicle.
Only the target of selected type will trigger the alarm.

Note:

If you want to detect human whose size is 0.5 meters wide, 1.8 meters high probably, the recommend settings are shown below.

Min. Size: 0.4*0.8(m)

Max. Size: 1.5*2.5(m)

Detection Target: Human.

- f) Draw the line on the live video and select the crossing direction.

Note: Up to 8 single rules are supported.

5. Click **Save** to save the settings.
6. Click **Arming Schedule** tab to set the schedule time for each rule.
7. Click **Linkage Method** tab, check the checkbox of corresponding linkage method for each rule.

9.3.5 Advanced Configuration

Behavior Analysis Version: It lists the version of the algorithms library.

- **Parameter**

Configure the following parameters to detail the configuration.

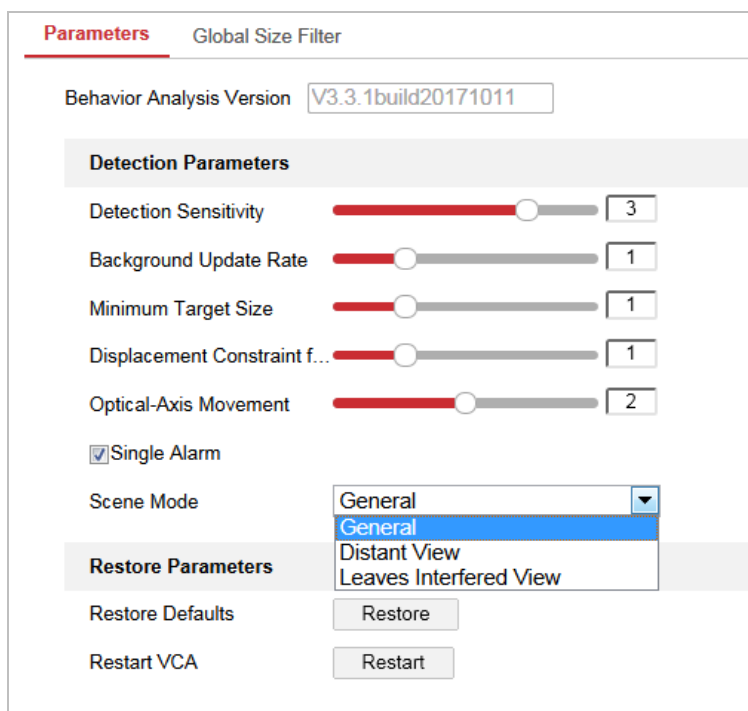

Figure 9-20 Advanced Configuration

Detection Sensitivity [0 - 4]: Refers to the sensitivity of the camera detects a target. The higher the value, the easier a target be recognized, and the higher the misinformation is. The default value of 3 is recommended.

Background Update Rate [0 - 4]: It refers to the speed of the new scene replaces the previous scene. The default value of 3 is recommended.

Minimum Target Size [0~4]: When the target size is smaller than the value, the system's VCA rule does not apply. The default value of 1 is recommended.

Displacement Constraint for Target Generation [0~4]: It refers to the target generating effect. The higher is the value, the target is more accurate and the target is generated slower.

Optical-Axis Movement: If the target moves in the camera's optical-axis direction, set the optical-axis movement sensitivity. The lower is the value, the

target is more accurate and the target is generated slower.

Single Alarm: If single alarm is selected, the target in the configured area will trigger the alarm for only once. If it is not checked, the same target will cause the continuous alarm in the same configured area.

Scene Mode:

General: In General mode, the behavior analysis works normally.

Distant View: When the camera is installed in outdoor environment, select Distant View mode.

Leaves Interfered View: When the camera is installed where the trees or leaves may interfere the view, select Leaves Interfered View mode.

Restore Default: Click to restore the configured parameters to the default.

Restart VCA: Restart the algorithms library of behavior analysis.

- **Global Size Filter**

Note: Compared with the size filter under rule, which is aiming at each rule, the global size filter is aim at all rules.

Steps:

1. Enter **Configuration > VCA > Advanced Configuration**.
2. Check the checkbox of **Global Size Filter** to enable the function.
3. Select the Filter Type as Actual Size or Pixel.

Actual Size: Input the length and width of both the maximum size and the minimum size. Only the target whose size is between the minimum value and maximum value will trigger the alarm.

Notes:

- Camera calibration has to be configured if you select the filter by

actual size.

- The length of the maximum size should be longer than the length of the minimum size, and so does the width.

Pixel: Click Minimum Size to draw the rectangle of the min. size on the live view. And click Maximum Size to draw the rectangle of the max. size on the live view. The target is smaller than the min. size or larger than the max. size will be filtered.

Notes:

- The drawn area will be converted to the pixel by the background algorithm.
 - The global size filter cannot be configured if the live view is stopped.
 - The length of the maximum size should be longer than the length of the minimum size, and so does the width.
4. Click **Save** to save the settings.

9.4 Temperature Measurement

9.4.1 Basic Settings

Purpose:

The device can measure the actual temperature of the spot being monitored. The device alarms when temperature exceeds the temperature threshold value.

Note: Before you use the temperature measurement function, enter Configuration > System > Maintenance > VCA Resource Type to select Temperature Measurement + Behavior Analysis as VCA Resource Type.

Steps:

1. Enter Configuration > Temperature Measurement > Basic Settings.

The screenshot shows the 'Basic Settings' tab of a configuration interface. It includes the following elements:

- Channel No. dropdown menu set to 'Camera2'.
- Enable Temperature Measurement checkbox (unchecked).
- Enable Color-Temperature checkbox (checked).
- Display Temperature Info. on Stream checkbox (checked).
- Add Original Data on Capture checkbox (unchecked).
- Add Original Data on Stream checkbox (unchecked).
- Data Refresh Interval dropdown menu set to '3' with a unit 's'.
- Unit dropdown menu set to 'Degree Celsius(°C)'.
- Temperature Range dropdown menu set to '-20.0~150.0'.
- Version text input field containing 'V1.0.7build20161221'.
- A section titled 'Manual Temperature Me...' with a grey background.
- Emissivity text input field containing '0.98'.
- Distance text input field containing '20' with a unit 'm'.
- A red 'Save' button at the bottom.

Figure 9-21 Basic Settings

2. Check the checkboxes of the interface to set the temperature measurement configurations.

Enable Temperature Measurement: Check the checkbox to enable temperature measurement function.

Enable Color-Temperature: Check the checkbox to display temperature pallet in live view.

Display Temperature Info. on Stream: Check the checkbox to display temperature information in live view.

Add Original Data on Capture: Check the checkbox to add original data on capture.

Add Original Data on Stream: Check the checkbox to add original data on stream.

Data Refresh Interval: Select the data refresh interval from 1s to 5s.

Unit: Display temperature with Degree Celsius (°C)/ Degree Fahrenheit (°F)/ Degree Kelvin (K).

Temperature Range: Set the temperature range.

Emissivity: Set the emissivity of your target. Note: The emissivity of each object is different.

Algorithm Version: View the version of current algorithm.

Distance (m): The straight-line distance between the target and the device.

3. Click **Save** to save the settings.

9.4.2 Configuring Temperature Measurement Rule

Before you start:

The temperature measurement function is usually used together with alarm function. You can set the alarm linkage so that any alarm/pre-alarms can trigger the connected alarm. You can double click current screen to show full of it, and double click again to exit full screen.

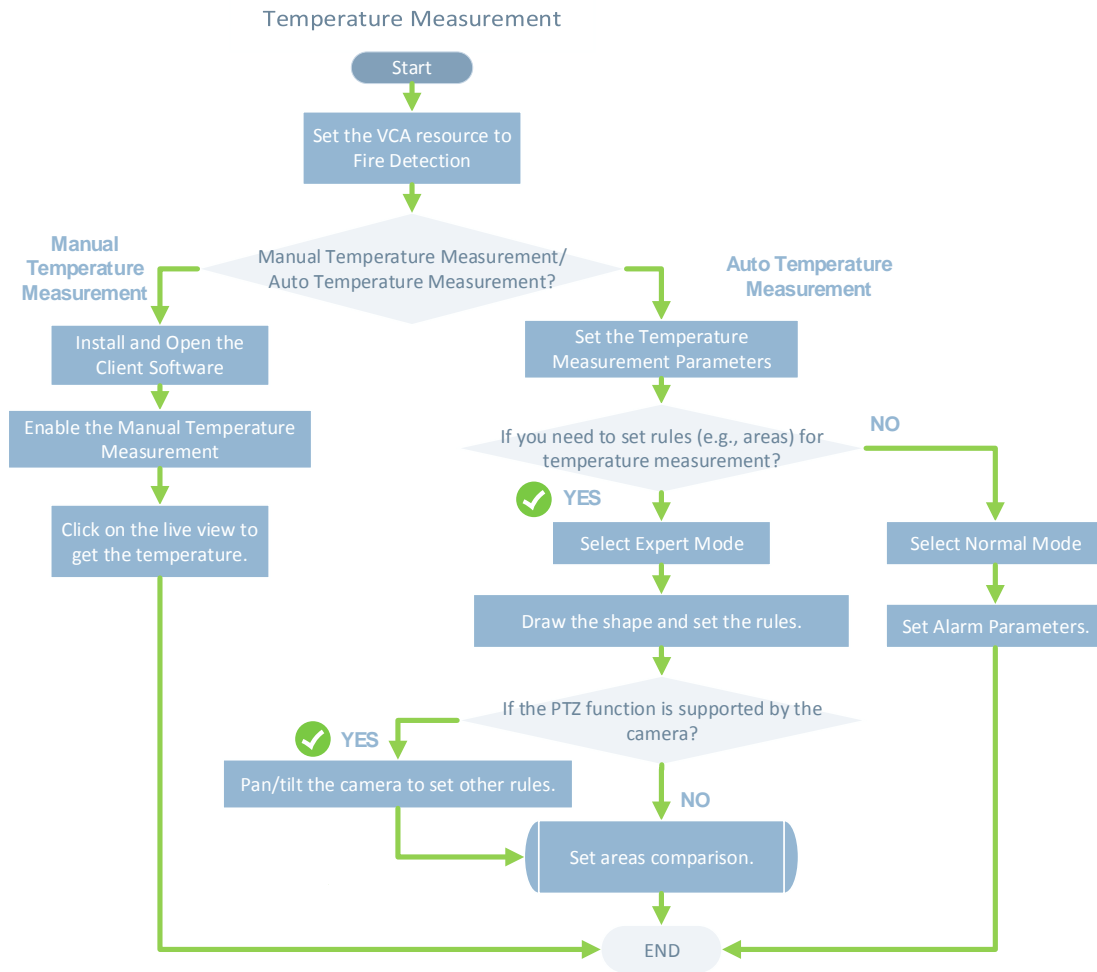

Purpose:

This function is used for measuring the temperature of detected spot and the device compares temperature of selected regions and alarms.

Steps:

(For Normal Mode)

1. Enter **Configuration > Temperature Measurement > Advanced Settings**.
2. Select the configuration mode as **Normal**.
3. Configure the parameters.

Emissivity: Set the emissivity of your target. Note: The emissivity of each object is different.

Distance (m): The straight-line distance between the target and the device.

Pre-Alarm: When the temperature of target exceeds the **Pre-Alarm Threshold**, and this status keeps NOT shorter than the **Filtering Time**, it triggers the Pre-Alarm.

Check the checkbox of Pre-Alarm Output to set link the pre-alarm with the connected alarm device.

Alarm: When the temperature of target exceeds the **Alarm Threshold**, and this status keeps NOT shorter than the **Filtering Time**, it triggers the Alarm.

Check the checkbox of **Alarm Output** to set link the pre-alarm with the connected alarm device.

4. Click **Save**.

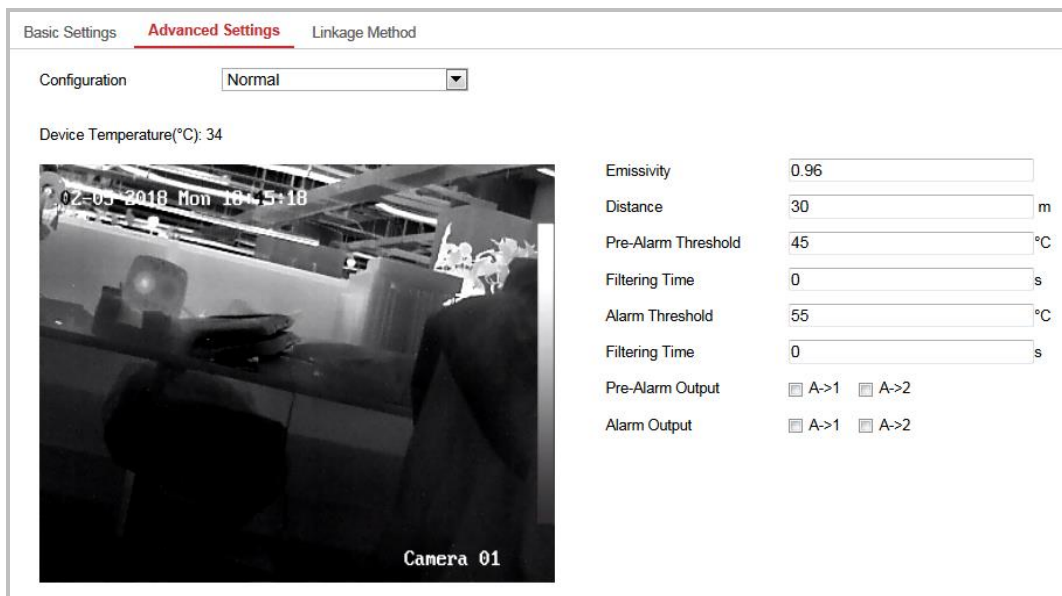

Figure 9-22 Temperature Measurement Configuration

(For Expert Mode)

1. Enter **Configuration > Temperature Measurement > Advanced Settings**.
2. Select the configuration mode as **Expert**.
3. Configure the parameters.

Name: You can customize the rule name.

Type: Select **Point, Line, or Area** as rule type.

Emissivity: Set the emissivity of your target. The emissivity of each object is different, you can refer to the Appendix for details.

Distance (m): The straight-line distance between the target and the device.

Reflective Temperature: If there is any object reflecting to the target, e.g., a mirror, enter the background temperature value/the reflecting object's temperature value. If not, uncheck the checkbox.

Tolerance Temperature: The triggered alarm does NOT stop until the temperature/temperature difference is lower/higher than rule temperature by tolerance temperature.

Example: set tolerance temperature as 3°C, set alarm temperature as 55°C. It alarms when its temperature reaches 55°C and only when the temperature is below 52°C will the alarm be cancelled.

Basic Settings **Advanced Settings** Linkage Method

Configuration

Device Temperature(°C): 30

02-26-2018 Mon 11:00:12

49.9°C

16.7°C

50.1°C

Camera 01

Clear All

Area's Temperature Comparison

Enable	ID	Name	Type	Emissivity	Distance(...)	Reflective Temp...	Alarm Rule
<input type="checkbox"/>	1		Point	0.96	30	<input type="checkbox"/> 20	<input checked="" type="checkbox"/>
<input type="checkbox"/>	2		Point	0.96	30	<input type="checkbox"/> 20	<input checked="" type="checkbox"/>
<input type="checkbox"/>	3		Point	0.96	30	<input type="checkbox"/> 20	<input checked="" type="checkbox"/>
<input type="checkbox"/>	4		Point	0.96	30	<input type="checkbox"/> 20	<input checked="" type="checkbox"/>
<input type="checkbox"/>	5		Point	0.96	30	<input type="checkbox"/> 20	<input checked="" type="checkbox"/>
<input type="checkbox"/>	6		Point	0.96	30	<input type="checkbox"/> 20	<input checked="" type="checkbox"/>

Figure 9-23 Temperature Measurement Configuration

4. Check the Enable checkbox to enable the alarm rule.

For Point Rule:

- a) Click  to show the Alarm Rule setting interface.

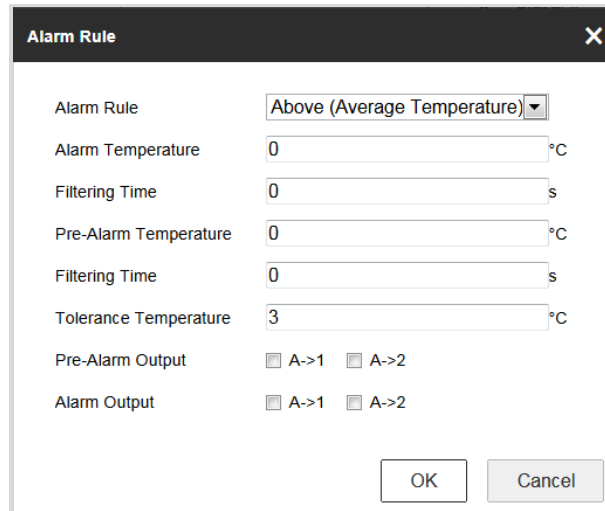

Figure 9-24 Alarm Rule Settings (Point)

- b) Set the **Alarm Rule**.
- c) Set the **Alarm Temperature**, **Pre-Alarm Temperature**, and **Tolerance Temperature**.
- d) Set the **Filtering Time**.
- e) Set the **Pre-Alarm Output** and **Alarm Output** with the connected alarm sensor and alarm device.

Example: select **Alarm Rule** as **Above (Average Temperature)**, set the **Alarm Temperature** to 50 °C and **Filtering Time** as 5 s, and then the device alarms when its average temperature keeps being above 50 °C for over 5 s.

For Line and Area Rule:

- a) Click  to show the Alarm Rule setting interface.

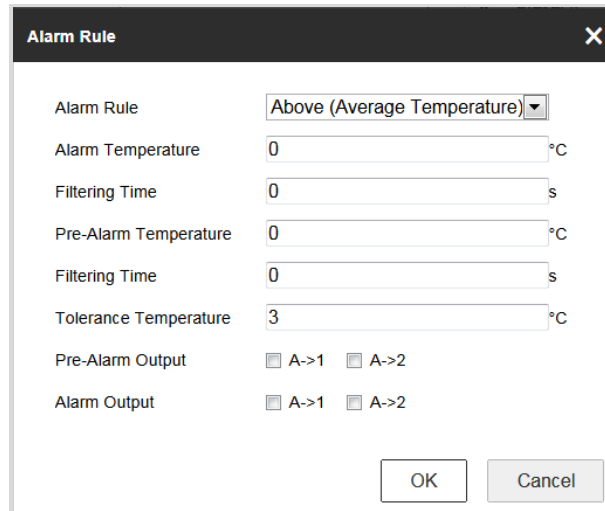

Figure 9-25 Alarm Rule Settings (Line)

- b) Set the **Alarm Rule**.
- c) Set the **Alarm Temperature**, **Pre-Alarm Temperature**, and **Tolerance Temperature**.
- d) Set the **Filtering Time**.
- e) Set the **Pre-Alarm Output** and **Alarm Output** with the connected alarm sensor and alarm device.

Example: select Alarm Rule as Min. Temperature is Lower than, and set the Alarm Temperature to 40 °C, and the device alarms when the minimum temperature is lower than 40 °C.

For Area Temperature Comparison:

Make sure you have enabled the areas for comparison.

- a) Click **Area's Temperature Comparison** to enter the area temperature comparison interface.

- b) Select the areas.

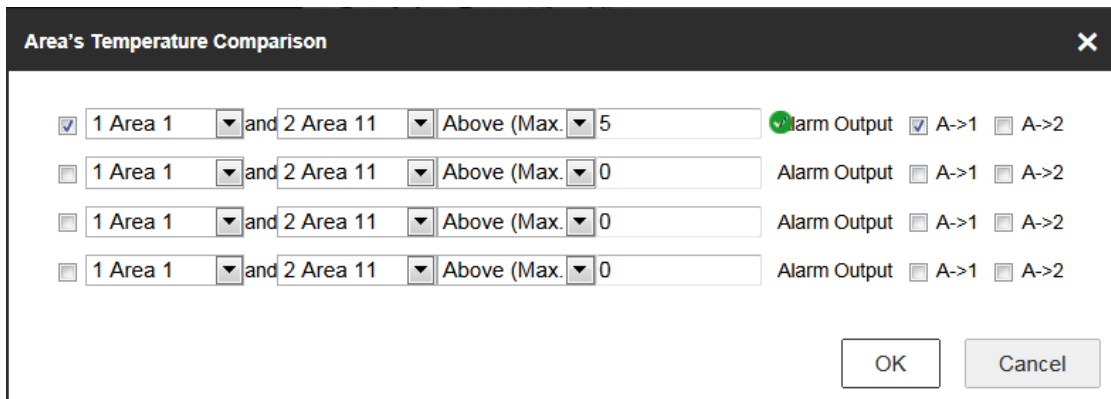

Figure 9-26 Area Temperature Comparison Alarm

- c) Select the comparison rule.
 d) Set the temperature difference threshold value.

Example: select **Area 1** and **Area 11**, and set the comparison rule as **Above (Max. Temperature)**, and set the temperature difference threshold to 5 °C. The device alarms when the difference of two areas' maximum temperature is above 5 °C.

9.4.3 Linkage Method

Purpose:

Set the linkage method of the alarm.

Steps:

1. Enter **Configuration > Temperature Measurement > Linkage Method**.
2. Set the arming schedule and linkage method.

Arming Schedule: Click on the time bar and drag the mouse to select

the time period.

Linkage Method: Click Linkage Method and check the checkbox to select the linkage method. Audible warning, notify surveillance center, send email, upload to FTP, trigger channel and trigger alarm output are selectable. You can specify the linkage method when an event occurs.

3. Click **Save** to save the settings.

After the settings, you can view the current temperature and humidity on the top of this interface.

Chapter 10 Storage Settings

Before you start:

To configure record settings, please make sure that you have the network storage device or local storage device configured.

10.1 Configuring Record Schedule

Purpose:

There are two kinds of recording for the cameras: manual recording and scheduled recording. In this section, you can follow the instructions to configure the scheduled recording. By default, the record files of scheduled recording are stored in the local storage or in the network disk.

Steps:

1. Enter the Record Schedule Settings interface: **Configuration > Storage > Schedule Settings > Record Schedule.**

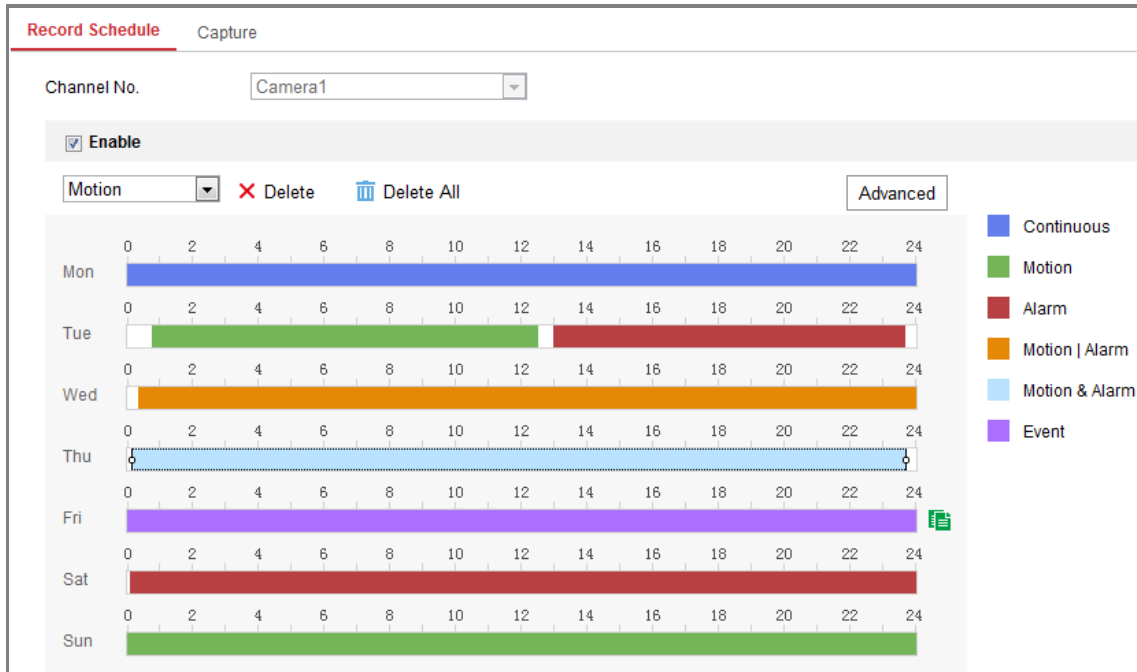

Figure 10-1 Recording Schedule Interface

2. Check the checkbox of **Enable** to enable scheduled recording.
3. Click **Advanced** to set the camera record parameters.

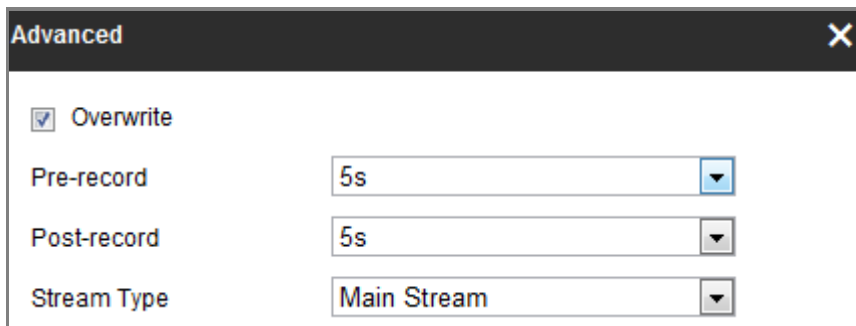

Figure 10-2 Record Parameters

Pre-record: The time you set to start recording before the scheduled time or the event. For example, if an alarm triggers recording at 10:00, and the pre-record time is set as 5 seconds, the camera starts to record at 9:59:55.

The Pre-record time can be configured as No Pre-record, 5s, 10s, 15s,

20s, 25s, 30s or not limited.

Post-record: The time you set to stop recording after the scheduled time or the event. For example, if an alarm triggered recording ends at 11:00, and the post-record time is set as 5 seconds, the camera records until 11:00:05.

The Post-record time can be configured as 5s, 10s, 30s, 1 min, 2 min, 5 min or 10 min.

Stream Type: Select the stream type for recording.

Note: The record parameter configurations vary depending on the camera model.

4. Select a **Record Type**. The record type can be Continuous, Motion Detection, Alarm, Motion | Alarm, Motion & Alarm, and Event.

Continuous

If you select **Continuous**, the video will be recorded automatically according to the time of the schedule.

Record Triggered by Motion Detection

If you select **Motion Detection**, the video will be recorded when the motion is detected.

Besides configuring the recording schedule, you have to set the motion detection area and check the checkbox of Trigger Channel in the Linkage Method of Motion Detection Settings interface. For detailed information, please refer to the *Task 1: Set the Motion Detection Area* in

the *Section 9.1.1*.

Record Triggered by Alarm

If you select **Alarm**, the video will be recorded when the alarm is triggered via the external alarm input channels.

Besides configuring the recording schedule, you have to set the **Alarm Type** and check the checkbox of **Trigger Channel** in the **Linkage Method of Alarm Input Settings** interface. For detailed information, please refer to *Section 9.1.3*.

Record Triggered by Motion & Alarm

If you select **Motion & Alarm**, the video will be recorded when the motion and alarm are triggered at the same time.

Besides configuring the recording schedule, you have to configure the settings on the **Motion Detection** and **Alarm Input Settings** interfaces. Please refer to *Section 9.1.1* and *Section 9.1.3* for detailed information.

Record Triggered by Motion | Alarm

If you select **Motion | Alarm**, the video will be recorded when the external alarm is triggered or the motion is detected.

Besides configuring the recording schedule, you have to configure the settings on the **Motion Detection** and **Alarm Input Settings** interfaces. Please refer to *Section 9.1.1* and *Section 9.1.3* for detailed information.

Record Triggered by Events

If you select **Event**, the video will be recorded if any of the events is

triggered. Besides configuring the recording schedule, you have to configure the event settings.

5. Select the record type, and click-and-drag the mouse on the time bar to set the record schedule.
6. Click **Save** to save the settings.

10.2 Configure Capture Schedule

Purpose:

You can configure the scheduled snapshot and event-triggered snapshot. The captured picture can be stored in the local storage or network storage.

Steps:

1. Enter the Capture Settings interface: **Configuration > Storage > Storage Settings > Capture.**

The screenshot shows the 'Record Schedule' interface with the 'Capture' tab selected. The interface includes a 'Capture Schedule' tab and a 'Capture Parameters' tab. A dropdown menu is set to 'Continuous', with 'Delete' and 'Delete All' buttons next to it. An 'Advanced' button is also present. The main area displays a grid for configuring the capture schedule for each day of the week (Mon-Sun). The grid shows a 24-hour time bar (0 to 24) for each day, with a blue bar indicating the 'Continuous' capture schedule. A legend on the right shows a blue square labeled 'Continuous'. At the bottom, there is a red 'Save' button.

Figure 10-3 Capture Configuration

2. Go to **Capture Schedule** tab to configure the capture schedule by click-and-drag the mouse on the time bar. You can copy the record schedule to other days by clicking the green copy icon on the right of each time bar.
3. Click **Advanced** to select stream type.

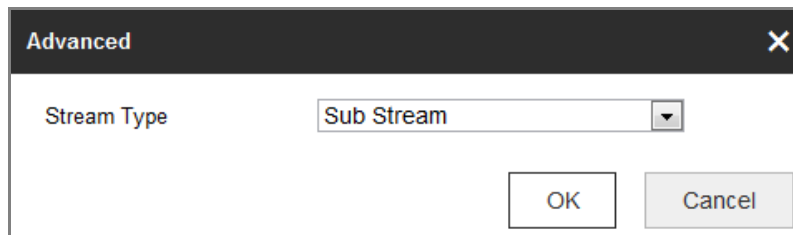
**Figure 10-4** Advanced Setting of Capture Schedule

4. Click **Save** to save the settings.
5. Go to **Capture Parameters** tab to configure the capture parameters.
 - (1) Check the **Enable Timing Snapshot** checkbox to enable continuous snapshot.
 - (2) Select the picture format, resolution, quality and capture interval.
 - (3) Check the **Enable Event-triggered Snapshot** checkbox to enable event-triggered snapshot.
 - (4) Select the picture format, resolution, quality, capture interval, and capture number.

Record Schedule **Capture**

Capture Schedule > Capture Parameters

Timing

Enable Timing Snapshot

Format: JPEG

Resolution: 704*576

Quality: High

Interval: 500 milliseconds

Event-Triggered

Enable Event-Triggered Snapshot

Format: JPEG

Resolution: 704*576

Quality: High

Interval: 500 milliseconds

Capture Number: 4

Save

Figure 10-5 Set Capture Parameters

6. Set the time interval between two snapshots.
7. Click **Save** to save the settings.

10.3 Configuring Net HDD

Before you start:

The network disk should be available within the network and properly configured to store the recorded files, log files, pictures, etc.

Steps:

1. Add Net HDD.
 - (1) Enter the Net HDD settings interface, **Configuration > Storage >**

Storage Management > Net HDD.

HDD Management Net HDD				
Net HDD				
HDD No.	Server Address	File Path	Type	Delete
1	10.10.36.61	/cxy_1	NAS	✘
Mounting Type: SMB/CIFS User Name: <input type="text" value="cxy1"/> Password: <input type="password" value="••••••"/> <input type="button" value="Test"/>				
2	10.10.36.252	/dvr/yanjian_1	NAS	✘
3			NAS	✘

Figure 10-6 Add Network Disk

- (2) Enter the IP address of the network disk, and enter the file path.
- (3) Select the mounting type. NFS and SMB/CIFS are selectable. And you can set the user name and password to guarantee the security if SMB/CIFS is selected.

Note: Please refer to the *NAS User Manual* for creating the file path.



For your privacy and to better protect your system against security risks, we strongly recommend the use of strong passwords for all functions and network devices. The password should be something of your own choosing (using a minimum of 8 characters, including at least three of the following categories: upper case letters, lower case letters, numbers and special characters) in order to increase the security of your product.

Proper configuration of all passwords and other security settings is the responsibility of the installer and/or end-user.

- (4) Click **Save** to add the network disk.

2. Initialize the added network disk.

- (1) Enter the HDD Settings interface, **Configuration > Storage > Storage Management > HDD Management**, in which you can view the capacity, free space, status, type and property of the disk.

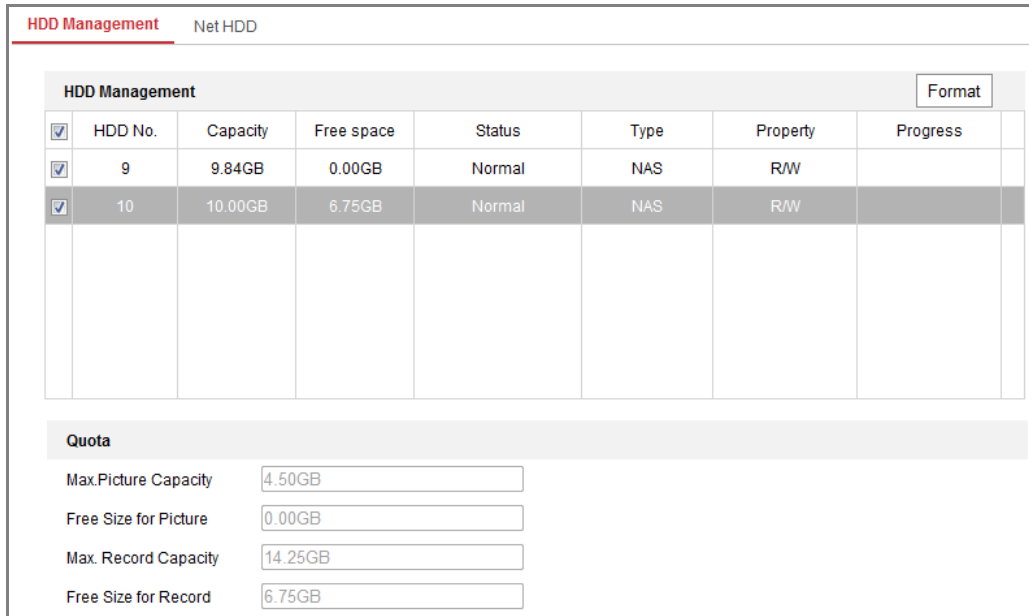

Figure 10-7 Storage Management Interface

- (2) If the status of the disk is **Uninitialized**, check the corresponding checkbox to select the disk and click **Format** to start initializing the disk.

When the initialization completed, the status of disk will become **Normal**.

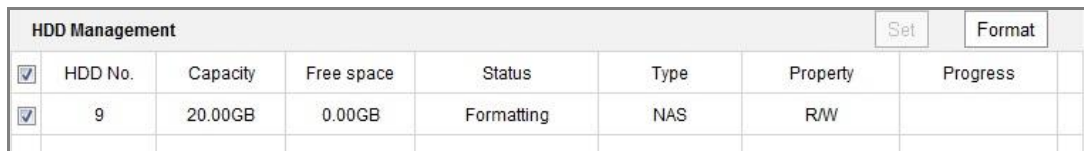
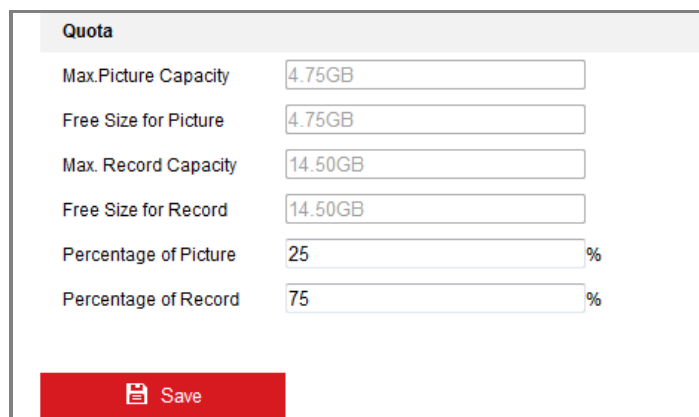

Figure 10-8 View Disk Status

3. Define the quota for record and pictures.

- (1) Input the quota percentage for picture and for record.
- (2) Click **Save** and refresh the browser page to activate the settings.



Quota	
Max. Picture Capacity	4.75GB
Free Size for Picture	4.75GB
Max. Record Capacity	14.50GB
Free Size for Record	14.50GB
Percentage of Picture	25%
Percentage of Record	75%

Save

Figure 10-9 Quota Settings

Note:

Up to 8 NAS disks can be connected to the camera.

10.4 Memory Card Detection

Purpose:

With memory card detection, you can view the memory card status, lock your memory card, and receive notification when your memory card is detected abnormal.

Note: Memory card detection function is only supported by certain types of memory cards and camera models. If this tab page doesn't show on your web page, it means either that your camera doesn't support the function, or your installed memory card is not supported for this function. You can contact the dealer or the retailer for the information of memory card that supports the function.

Steps:

1. Enter Memory Card Detection configuration interface:

Configuration > Storage > Storage Management > Memory Card Detection

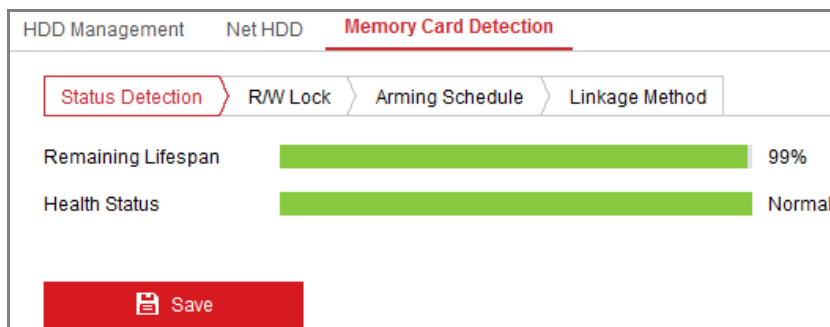

Figure 10-10 Memory Card Detection

2. View the memory card status on **Status Detection** tab.

Remaining Lifespan: It shows the percentage of the remaining lifespan. The lifespan of a memory card may be influenced by factors such as its capacity and the bitrate. You need to change the memory card if the remaining lifespan is not enough.

Health Status: It shows the condition of your memory card. There are three status descriptions, good, bad, and damaged. You will receive a notification if the health status is anything other than good when the **Arming Schedule** and **Linkage Method** are set.

Note: It is recommended that you change the memory card when the health status is not "good".

3. Click **R/W Lock** tab to add a lock to the memory card.

With the R/W lock added, the memory card can only be read and write when it is unlocked.

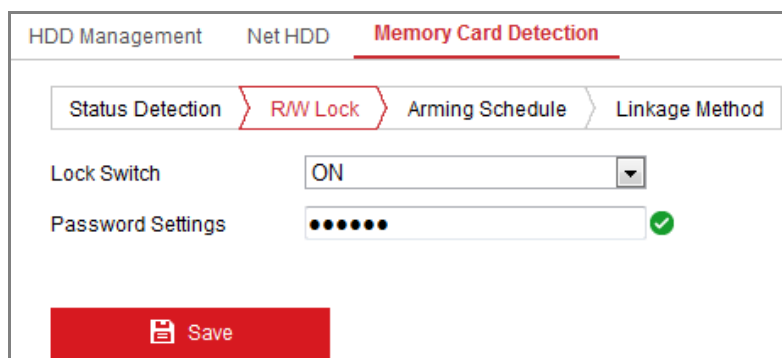

Figure 10-11 R/W Lock Setting

Add a Lock

- (1) Select the **Lock Switch** as ON.
- (2) Input the password.
- (3) Click **Save** to save the settings.

Unlock

- (1) If you use the memory card on the camera that locks it, unlocking will be done automatically and no unlocking procedures are required on the part of users.
- (2) If you use the memory card (with a lock) on a different camera, you can go to **HDD Management** interface to unlock the memory card manually. Select the memory card, and click the **Unlock** button shown next to the **Format** button. Then input the correct password to unlock it.

Notes:

- The memory card can only be read and written in when it is unlocked.
- If the camera, which adds a lock to a memory card, is restored to the factory settings, you can go to the HDD Management interface

to unlock the memory card.

Remove the Lock

- (1) Select the **Lock Switch** as **OFF**.
 - (2) Input the correct password in **Password Settings** text field.
 - (3) Click **Save** to save the settings.
4. Set the **Arming Schedule** and **Linkage Method**, if you want to receive a notification when the health status of the memory card is anything other than good. Refer to *Task 2: Set the Arming Schedule for Motion Detection* and *Task 3: Set the Linkage Method for Motion Detection* in Section 9.1.1.
5. Click **Save** to save the settings.

10.5 Configuring Lite Storage

Purpose:

When there is no moving object in the monitoring scenario, the frame rate and bitrate of the video stream can be reduced to lengthen the storage time of the memory card.

Notes:

Lite storage function varies according to different camera models.

The video files recorded in lite storage mode will be played back in full frame rate (25fps/30fps), and thus the playback process is speeded up to the eye.

1. Enter the Lite Storage interface:

Configuration > Storage > Storage Management > Lite Storage

2. Check the Checkbox of **Enable** to enable the lite storage function.
3. Input the storage time in the text field. You can view the available space of the SD card on the page.
4. Click **Save** to save the settings.

Chapter 11 Open Platform setting

Purpose:

The open platform helps users to import third-party application to device and create a variety of smart functions.

Note: This function is only available to certain camera models. And please contact supplier to get the third-party software first

Before you start:

1. Enter VCA Resource Type interface: **Configuration > System > Maintenance > VCA Resource Type.**
2. Check the checkbox to enable **Temperature Measurement + Open Platform**
3. Click **Save**. A reboot is required after setting the VCA Resource.

Steps:

1. Click Browse to choose the software.
2. Click Import, then you can check the statue of the software in status table.
3. Click Start or Stop to operate the software.
4. Click Delete if you want to delete the software.

If there is an upgrade version of third-party application, you can delete the former application first and then import new one, or just import the latest application to replace the old one.

5. Click Log to check the operation log.

Application

Import Application

Application Packages

Status

No.	Software name	Version	Company	Status
1	xxxxxx	2.3.0	xxxx	Start
2	xxxxxx	V1.1.0_Web3.0	xxxx	Start

Figure 11-1 Open Platform

Chapter 12 Playback

Purpose:

This section explains how to view the remotely recorded video files stored in the network disks or SD cards.

Steps:

1. Click **Playback** on the menu bar to enter playback interface.

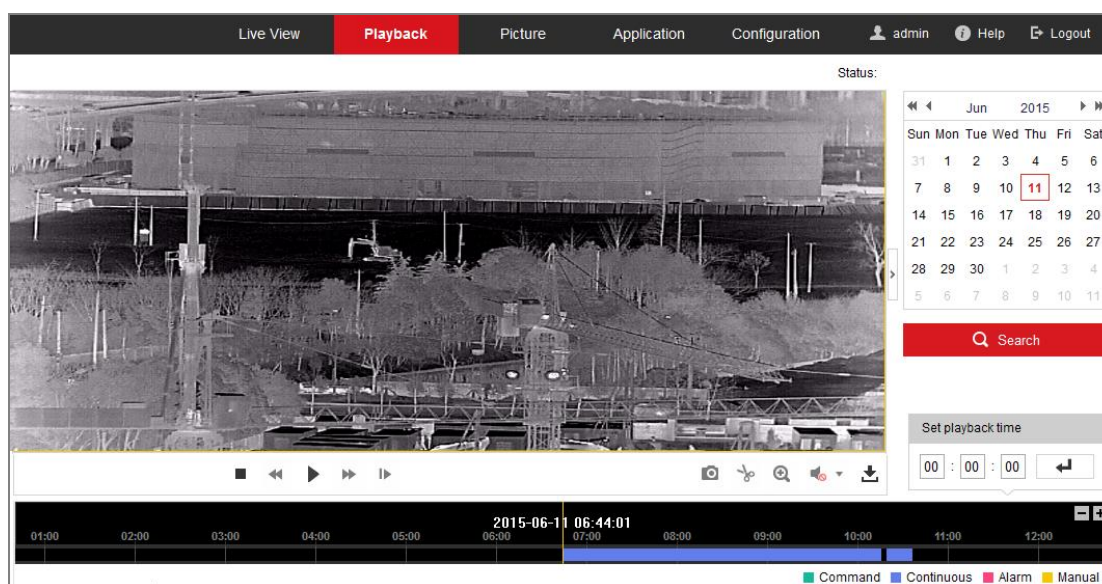

Figure 12-1 Playback Interface

2. Select the date and click **Search**.



Figure 12-2 Search Video















3. Click  to play the video files found on this date.

The toolbar on the bottom of Playback interface can be used to control playing process.





Figure 12-3 Playback Toolbar

Table 12-1 Description of the buttons

Button	Operation	Button	Operation
	Play		Capture a picture
	Pause	 / 	Start/Stop clipping video files
	Stop	  	Audio on and adjust volume/Mute
	Speed down		Download
	Speed up		Playback by frame
	Enable/Disable digital zoom		

Note: You can choose the file paths locally for downloaded playback video files and pictures in Local Configuration interface.

You can also input the time and click  to locate the playback point in the **Set playback time** field. You can also click  to zoom out/in the progress bar.

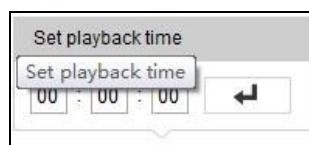

Figure 12-4 Set Playback Time

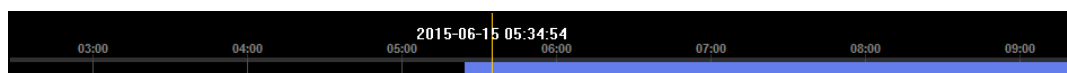

Figure 12-5 Progress Bar

The different colors of the video on the progress bar stand for the different video types.

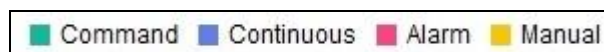

Figure 12-6 Video Types

Chapter 13 Picture

Click Picture to enter the picture searching interface. You can search, view, and download the pictures stored in the local storage or network storage.

Notes:

Make sure HDD, NAS or memory card are properly configured before you process the picture search.

Make sure the capture schedule is configured. Go to **Configuration > Storage > Schedule Settings > Capture** to set the capture schedule.

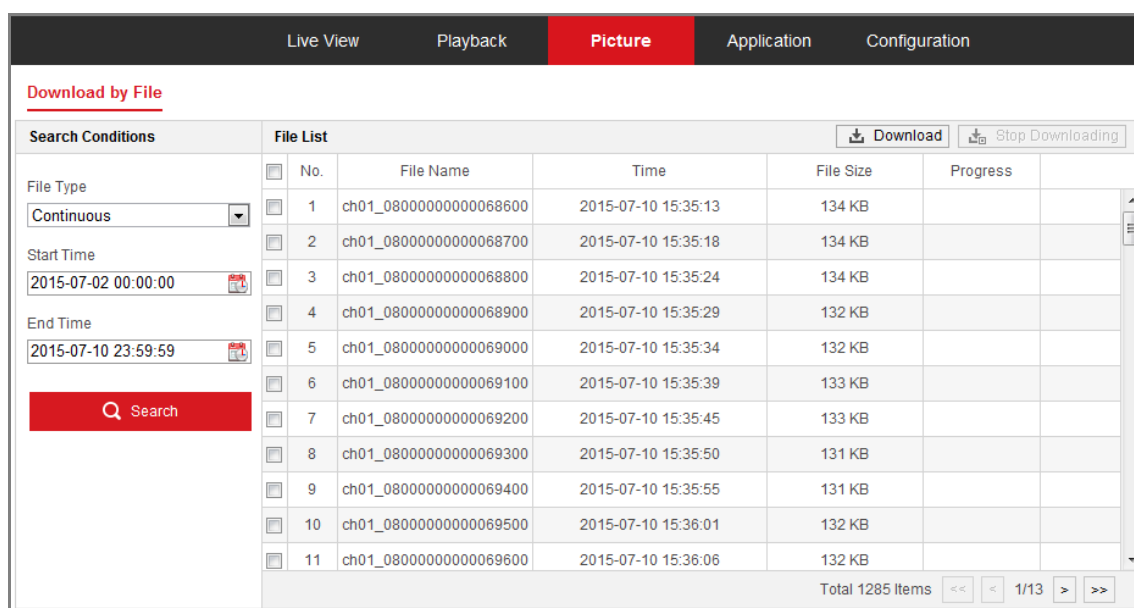

The screenshot displays the 'Picture' search interface. At the top, there are navigation tabs: 'Live View', 'Playback', 'Picture' (highlighted in red), 'Application', and 'Configuration'. Below the tabs, the interface is titled 'Download by File'. On the left, there are search conditions: 'File Type' (set to 'Continuous'), 'Start Time' (2015-07-02 00:00:00), and 'End Time' (2015-07-10 23:59:59). A red 'Search' button is located below these fields. On the right, a 'File List' table is shown with columns for 'No.', 'File Name', 'Time', 'File Size', and 'Progress'. The table contains 11 rows of data. At the bottom right, there are navigation controls for the file list, including 'Total 1285 Items' and page navigation buttons (1/13).

No.	File Name	Time	File Size	Progress
1	ch01_08000000000068600	2015-07-10 15:35:13	134 KB	
2	ch01_08000000000068700	2015-07-10 15:35:18	134 KB	
3	ch01_08000000000068800	2015-07-10 15:35:24	134 KB	
4	ch01_08000000000068900	2015-07-10 15:35:29	132 KB	
5	ch01_08000000000069000	2015-07-10 15:35:34	132 KB	
6	ch01_08000000000069100	2015-07-10 15:35:39	133 KB	
7	ch01_08000000000069200	2015-07-10 15:35:45	133 KB	
8	ch01_08000000000069300	2015-07-10 15:35:50	131 KB	
9	ch01_08000000000069400	2015-07-10 15:35:55	131 KB	
10	ch01_08000000000069500	2015-07-10 15:36:01	132 KB	
11	ch01_08000000000069600	2015-07-10 15:36:06	132 KB	

Figure 13-1 Picture Search Interface

Steps:

1. Select the file type from the dropdown list. Continuous, Motion, Alarm, Motion | Alarm, Motion & Alarm, Line Crossing, Intrusion Detection, and Scene Change Detection are selectable.
2. Select the start time and end time.

3. Click **Search** to search the matched pictures.
4. Check the checkbox of the pictures and then click **Download** to download the selected pictures.

Note:

Up to 4000 pictures can be displayed at one time.

Appendix

Appendix 1 SADP Software Introduction

Description of SADP

SADP (Search Active Devices Protocol) is a kind of user-friendly and installation-free online device search tool. It searches the active online devices within your subnet and displays the information of the devices. You can also modify the basic network information of the devices using this software.

Search active devices online

Search online devices automatically

After launch the SADP software, it automatically searches the online devices every 15 seconds from the subnet where your computer locates. It displays the total number and information of the searched devices in the Online Devices interface. Device information including the device type, IP address and port number, etc. will be displayed.

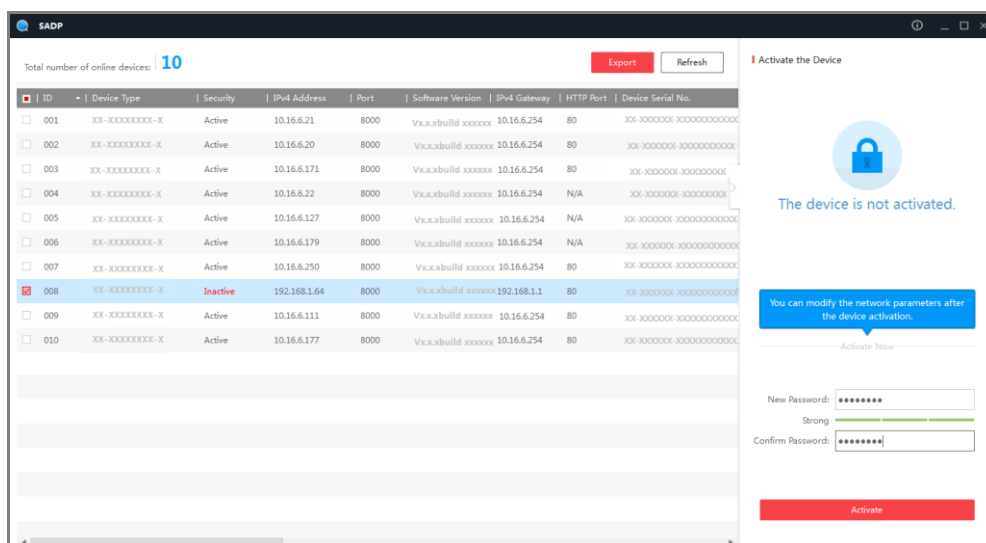

Figure A.1.1 Searching Online Devices

Note:





Device can be searched and displayed in the list in 15 seconds after it went online; it will be removed from the list in 45 seconds after it went offline.

Search online devices manually

You can also click  to refresh the online device list manually.

The newly searched devices will be added to the list.



You can click  or  on each column heading to order the information; you can click  to expand the device table and hide the network parameter panel on the right side, or click  to show the network parameter panel.

Modify network parameters**Steps:**

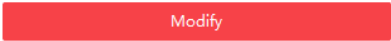
1. Select the device to be modified in the device list and the network parameters of the device will be displayed in the **Modify Network Parameters** panel on the right side.
2. Edit the modifiable network parameters, e.g. IP address and port number.
3. Enter the password of the admin account of the device in the **Admin Password** field and click  to save the changes.



For your privacy and to better protect your system against security risks, we strongly recommend the use of strong passwords for all functions and

network devices. The password should be something of your own choosing (using a minimum of 8 characters, including at least three of the following categories: upper case letters, lower case letters, numbers and special characters) in order to increase the security of your product.

Proper configuration of all passwords and other security settings is the responsibility of the installer and/or end-user.

Modify Network Parameters

Enable DHCP

Device Serial No.: XX-XXXXXX-XXXXXXXXXXXXXXXXXX

IP Address: 10.16.5.106

Port: 8003

Subnet Mask: 255.255.255.0

Gateway: 0.0.0.0

IPv6 Address:

IPv6 Gateway:

IPv6 Prefix Length:

HTTP Port: 0

Security Verification

Admin Password: ●●●●●●●●

Modify

[Forgot Password](#)

Figure A.1.2 Modify Network Parameters

Appendix 2 Port Mapping

The following settings are for TP-LINK router (TL-WR641G). The settings vary depending on different models of routers.

Steps:

1. Select the **WAN Connection Type**, as shown below:

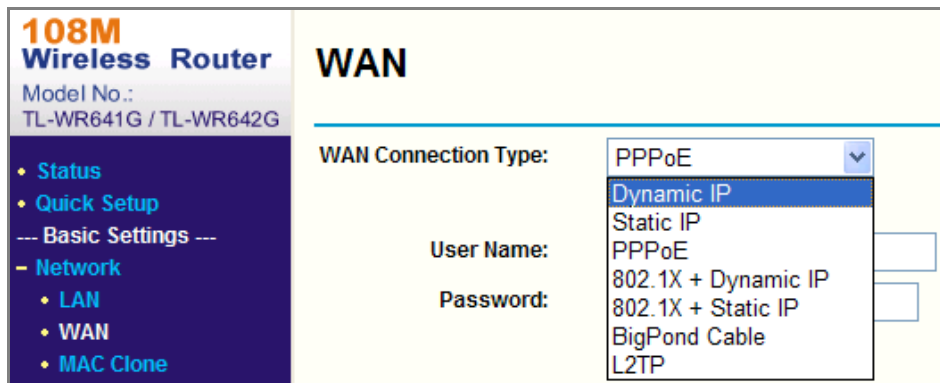

Figure A.2.1 Select the WAN Connection Type

2. Set the **LAN** parameters of the router as in the following figure, including IP address and subnet mask settings.

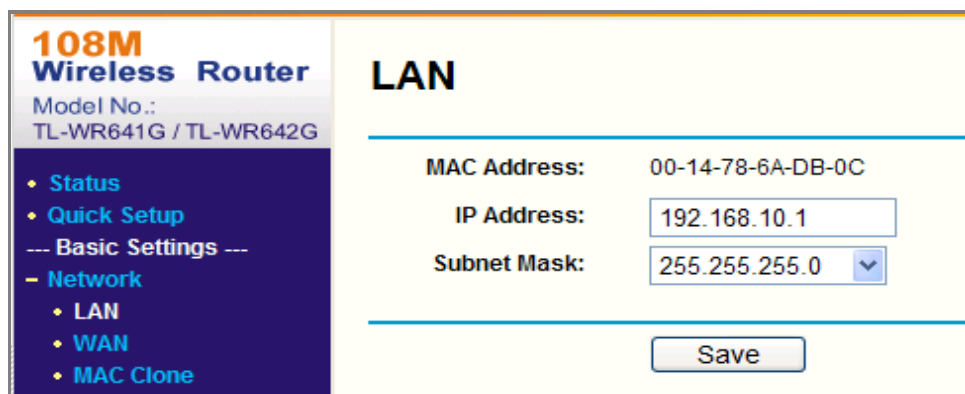

Figure A.2.2 Set the LAN parameters

3. Set the port mapping in the virtual servers of **Forwarding**. By default, camera

uses port 80, 8000 and 554. You can change these ports value with web browser or client software.

Example:

When the cameras are connected to the same router, you can configure the ports of a camera as 80, 8000, and 554 with IP address 192.168.1.23, and the ports of another camera as 81, 8001, 555, 8201 with IP 192.168.1.24.

Refer to the steps as below:

Steps:

1. As the settings mentioned above, map the port 80, 8000, 554 and 8200 for the network camera at 192.168.1.23
2. Map the port 81, 8001, 555 and 8201 for the network camera at 192.168.1.24.
3. Enable **ALL** or **TCP** protocols.
4. Check the **Enable** checkbox and click **Save** to save the settings.

108M Wireless Router
Model No.: TL-WR641G / TL-WR642G

Virtual Servers

ID	Service Port	IP Address	Protocol	Enable
1	80	192.168.10.23	ALL	<input checked="" type="checkbox"/>
2	8000	192.168.10.23	ALL	<input checked="" type="checkbox"/>
3	554	192.168.10.23	ALL	<input checked="" type="checkbox"/>
4	8200	192.168.10.23	ALL	<input checked="" type="checkbox"/>
5	81	192.168.10.24	ALL	<input checked="" type="checkbox"/>
6	8001	192.168.10.24	ALL	<input checked="" type="checkbox"/>
7	555	192.168.10.24	ALL	<input checked="" type="checkbox"/>
8	8201	192.168.10.24	ALL	<input checked="" type="checkbox"/>

Common Service Port: DNS(53) Copy to ID 1

Previous Next Clear All Save

Figure A.2.3 Port Mapping

Note: The port of the network camera cannot conflict with other ports. For example, some web management port of the router is 80. Change the camera port if it is the same as the management port.

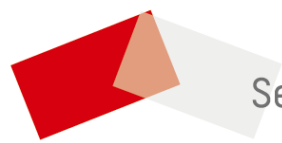

See Far, Go Further