

DS-2DF8C425MHS-DEL 4 MP 25 × Network Speed Dome

DarkFighterX

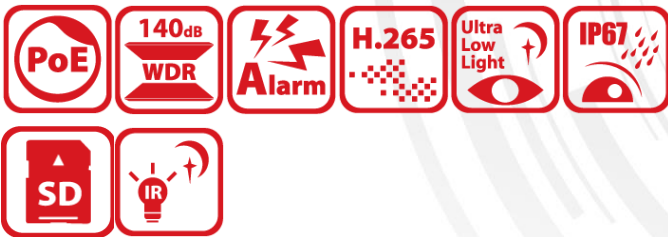

Hikvision DS-2DF8C425MHS-DEL(T5) 4MP 25 × Network Speed Dome adopts 1/1.8" progressive scan CMOS chip. With the 25 × optical zoom lens, the camera offers more details over expansive areas. This series of cameras can be widely used for wide ranges of high-definition, such as the rivers, forests, roads, railways, airports, ports, squares, parks, scenic spots, stations and large venues, etc.

- 1/1.8" progressive scan CMOS
- High quality imaging with 4 MP resolution
- Excellent low-light performance with DarkFighterX technology
- 25 × optical zoom and 16 × digital zoom provide close up views over expansive areas
- 300 m IR distance
- Water and dust resistant (IP67)
- Supports face capture to detect, capture, grade, and select faces in motion
- Efficient H.265+/H.265 compression technology
- 140 dB WDR, 3D DNR, HLC, BLC, EIS, defog
- Supports road traffic to detect vehicles



▪ DORI

The DORI (detect, observe, recognize, identify) distance gives the general idea of the camera ability to distinguish persons or objects within its field of view.

It is calculated based on the camera sensor specification and the criteria given by EN 62676-4: 2015.

| DORI | Detect | Observe | Recognize | Identify |
|-----------------|-----------------------|----------------------|--------------------|---------------------|
| Definition | 25 px/m | 63 px/m | 125 px/m | 250 px/m |
| Distance (Tele) | 2034.5 m (6674.9 ft.) | 807.3 m (2648.6 ft.) | 406.9 m (1335 ft.) | 203.5 m (667.3 ft.) |

▪ Specification

| Camera | |
|------------------------|---|
| Image Sensor | 1/1.8" Progressive Scan CMOS |
| Max. Resolution | 2560 × 1440 |
| Min. Illumination | Color: 0.0004 Lux @ (F1.6, AGC ON), B/W: 0.0001 Lux @ (F1.6, AGC ON), 0 Lux with IR |
| Shutter Speed | 1/1 s to 1/30000 s |
| Zoom | 25 × optical, 16 × digital |
| Slow Shutter | Yes |
| Lens | |
| Focal Length | 5.9 to 147.5 mm |
| FOV | Horizontal field of view: 59° to 3.05°, vertical field of view: 34.28° to 1.73°, diagonal field of view: 66.92° to 3.49° |
| Focus | Auto, semi-auto, manual, rapid focus |
| Aperture | F1.6 |
| Zoom Speed | Approx. 6.2 s |
| Illuminator | |
| Supplement Light Type | Hybrid |
| Supplement Light Range | IR distance: up to 300 m |
| Smart Supplement Light | Yes |
| PTZ | |
| Movement Range (Pan) | 0° to 360° |
| Movement Range (Tilt) | -20° to 90° |
| Pan Speed | Pan speed: configurable from 0.1° to 210°/s, preset speed: 280°/s |
| Tilt Speed | Tilt speed: configurable from 0.1° to 150°/s, preset speed 250°/s |
| Proportional Pan | Yes |
| Presets | 300 |
| Preset Freezing | Yes |
| Patrol Scan | 8 patrols, up to 32 presets for each patrol |
| Pattern Scan | 4 pattern scans, record time over 10 minutes for each scan |
| Park Action | Preset, pattern scan, patrol scan, auto scan, tilt scan, random scan, frame scan, panorama scan |
| 3D Positioning | Yes |
| PTZ Status Display | Yes |
| Scheduled Task | Preset, pattern scan, patrol scan, auto scan, tilt scan, random scan, frame scan, panorama scan, dome reboot, dome adjust, aux output |
| Power-off Memory | Yes |

| Video | |
|-----------------------------|--|
| Main Stream | 50 Hz: 25 fps (2560 × 1440, 1920 × 1080, 1280 × 960, 1280 × 720) 60 Hz: 30 fps (2560 × 1440, 1920 × 1080, 1280 × 960, 1280 × 720) |
| Sub-Stream | 50 Hz: 25 fps (704 × 576, 640 × 480, 352 × 288) 60 Hz: 30 fps (704 × 480, 640 × 480, 352 × 240) |
| Third Stream | 50 Hz: 25 fps (1920 × 1080, 1280 × 960, 1280 × 720, 704 × 576, 640 × 480, 352 × 288) 60 Hz: 30 fps (1920 × 1080, 1280 × 960, 1280 × 720, 704 × 480, 640 × 480, 352 × 240) |
| Video Compression | Main stream: H.265+/H.265/H.264+/H.264, Sub-stream: H.265/H.264/MJPEG, Third stream: H.265/H.264/MJPEG |
| Video Bit Rate | 32 Kbps to 16 Mbps |
| H.264 Type | Baseline profile, Main profile, High profile |
| H.265 Type | Main profile |
| Scalable Video Coding (SVC) | H.264 and H.265 encoding |
| Region of Interest (ROI) | 8 fixed regions for each stream |
| Audio | |
| Audio Compression | G.711, G.722.1, G.726, MP2L2, PCM, AAC-LC |
| Audio Bit Rate | 64 Kbps (G.711), 16 Kbps (G.722.1), 16 Kbps (G.726), 32 to 192 Kbps (MP2L2), 16 to 64Kbps (AAC-LC) |
| Network | |
| Protocols | IPv4/IPv6, HTTP, HTTPS, 802.1X, QoS, FTP, TCP/IP, ICMP, DHCP, DNS, DDNS, RTP, RTSP, RTCP, PPPoE, UPnP, SMTP, SNMP, IGMP, UDP, Bonjour, NTP |
| Simultaneous Live View | Up to 20 channels |
| API | Open Network Video Interface (Profile S, Profile G, Profile T), ISAPI, SDK, ISUP |
| User/Host | Up to 32 users. 3 user levels: administrator, operator, and user |
| Security | Password protection, complicated password, IP address filter, HTTPS encryption, 802.1X authentication (EAP-TLS, EAP-LEAP, EAP-MD5), host authentication (MAC address), watermark |
| Network Storage | NAS (NFS, SMB/CIFS), auto network replenishment (ANR) |
| Client | iVMS-4200, HikCentral Pro, Hik-Connect |
| Web Browser | IE 10+, Chrome 57+, Firefox 52+, Safari 12+ |
| Image | |
| Image Parameters Switch | Yes |
| Image Settings | Saturation, brightness, contrast, sharpness, gain, and white balance adjustable by client software or web browser |
| Day/Night Switch | Day, night, auto, schedule |
| Wide Dynamic Range (WDR) | 140 dB |
| SNR | ≥ 52 dB |
| Defog | Optical defog |
| Image Stabilization | EIS |
| Image Enhancement | BLC, HLC, 3D DNR |
| Privacy Mask | 24 programmable polygon privacy masks, mask color or mosaic configurable |
| Regional Focus | Yes |
| Regional Exposure | Yes |

| Interface | |
|---|---|
| Video Output | CVBS: 1.0 V[p-p]/75 Ω, PAL/NTSC, BNC connector |
| Ethernet Interface | 1 RJ45 10M/100M self-adaptive Ethernet port |
| On-board Storage | Built-in memory card slot, support microSD/microSDHC/microSDXC card, up to 256 GB |
| Audio | 1 input (line in), max. input amplitude: 2-2.4 vpp, input impedance: 1 KΩ ± 10%, 1 output (line out), line level, output impedance: 600 Ω |
| Alarm | 7 input(s), 2 output(s) |
| RS-485 | 1 RS-485 (Half duplex, HIKVISION, Pelco-P, Pelco-D, self-adaptive) |
| Reset | Yes |
| Event | |
| Basic Event | Motion detection, video tampering alarm, exception, alarm input and output |
| Smart Event | Line crossing detection, intrusion detection, region entrance detection, region exiting detection, audio exception detection, unattended baggage detection, object removal detection |
| Alarm Linkage | Upload to FTP/NAS/memory card, notify surveillance center, send email, trigger alarm output, trigger recording, and PTZ actions (such as preset, patrol scan, pattern scan) |
| Smart Tracking | Manual tracking, auto-tracking |
| Deep Learning Function | |
| Face Capture | Supports detecting, tracking, capturing, grading, selecting of face in motion, and outputs the best face picture |
| Face Comparison | Recognizes face identity via face modeling, grading and comparing to those in face library |
| Road Traffic and Vehicle Detection | |
| Road Traffic | Support vehicle detection (license plate number, vehicle model, and vehicle color recognition) |
| General | |
| Power | 36 VDC ± 25%, max. 62 W, Hi-PoE |
| Dimension | ∅267 mm × 430 mm (∅10.5" × 16.9") |
| Weight | Approx. 10 kg (22.05 lb.) |
| Material | ADC12 |
| Operating Condition | -40 °C to 70 °C (-40 °F to 158 °F). Humidity 95% or less (non-condensing) |
| Vandal-proof Alarm | Yes |
| Heater | Yes |
| Wiper | No |
| Demist | Yes |
| Language | 33 languages: English, Russian, Estonian, Bulgarian, Hungarian, Greek, German, Italian, Czech, Slovak, French, Polish, Dutch, Portuguese, Spanish, Romanian, Danish, Swedish, Norwegian, Finnish, Croatian, Slovenian, Serbian, Turkish, Korean, Traditional Chinese, Thai, Vietnamese, Japanese, Latvian, Lithuanian, Portuguese (Brazil), Ukrainian |
| Approval | |
| EMC | FCC (47 CFR Part 15, Subpart B), CE-EMC (EN 55032: 2015, EN 61000-3-2: 2019, EN 61000-3-3: 2013 + A1: 2019, EN 50130-4: 2011 + A1: 2014), RCM (AS/NZS CISPR 32: 2015), IC (ICES-003: Issue 7), KC (KN 32: 2015, KN 35: 2015) |

| | |
|-------------|---|
| Safety | CE-LVD (EN 62368-1: 2014/A11: 2017), CB (IEC 62368-1: 2014 + A11), UL (UL 62368-1), BIS (IS 13252 (Part 1): 2010/IEC 60950-1: 2005), LOA (IEC/EN 60950-1) |
| Environment | CE-RoHS (2011/65/EU), WEEE (2012/19/EU), Reach (Regulation (EC) No 1907/2006) |
| Protection | IP67 (IEC 60529-2013), IK10 (IEC 62262:2002), TVS 6K V lightning protection, surge protection and voltage transient protection |

▪ Available Model

DS-2DF8C425MHS-DEL

▪ Typical Application

Hikvision products are classified into three levels according to their anti-corrosion performance. Refer to the following description to choose for your using environment.

This model has NO SPECIFIC PROTECTION.





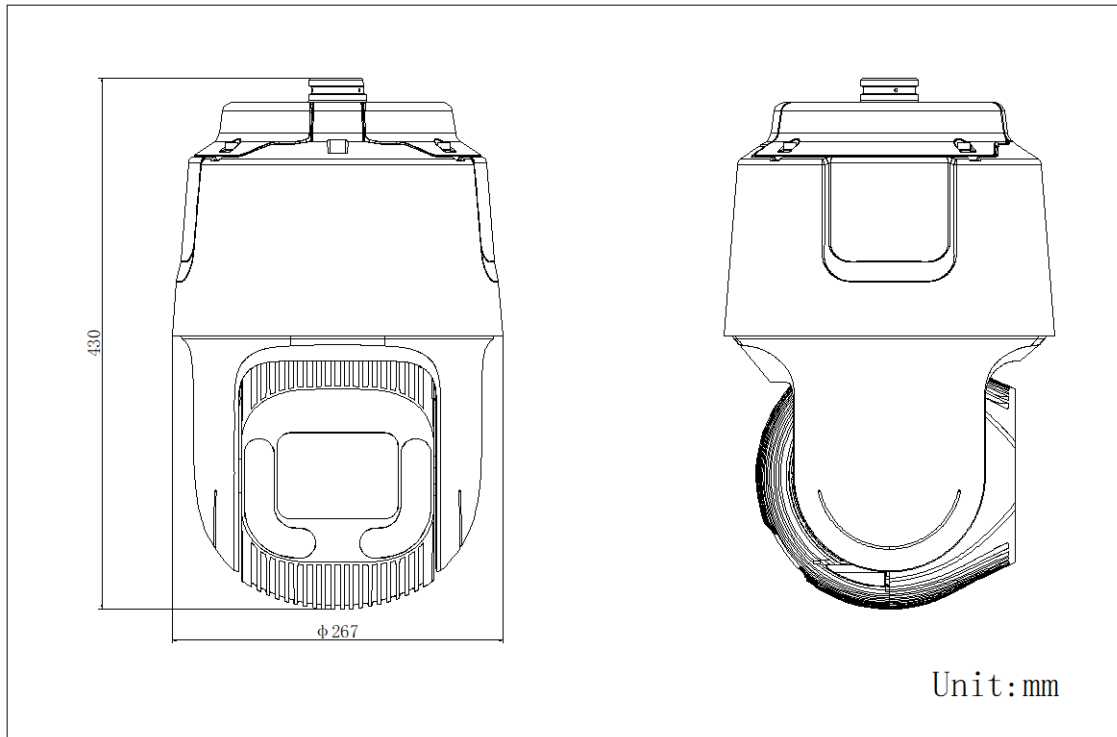

| Level | Description |
|------------------------|--|
| Top-level protection | Hikvision products at this level are equipped for use in areas where professional anti-corrosion protection is a must. Typical application scenarios include coastlines, docks, chemical plants, and more. |
| Moderate protection | Hikvision products at this level are equipped for use in areas with moderate anti-corrosion demands. Typical application scenarios include coastal areas about 2 kilometers (1.24 miles) away from coastlines, as well as areas affected by acid rain. |
| No specific protection | Hikvision products at this level are equipped for use in areas where no specific anti-corrosion protection is needed. |

▪ Dimension



▪ Accessory

▪ Optional

| DS-1603ZJ-Corner -P | DS-1668ZJ(20)-P | DS-1619ZJ-HP2 | DS-1673ZJ-P | DS-1668ZJ-P |
|---|---|---|---|---|
|  |  |  |  |  |
| DS-1603ZJ-P | DS-1603ZJ-Pole- P | | | |
|  |  | | | |

Distributed by

**HIKVISION®****Headquarters**

No.555 Qianmo Road, Binjiang District,
Hangzhou 310051, China
T +86-571-8807-5998
overseasbusiness@hikvision.com

Hikvision USA
T +1-909-895-0400
sales.usa@hikvision.com

Hikvision Australia
T +61-2-8599-4233
salesau@hikvision.com

Hikvision India
T +91-22-28469900
sales@pramahikvision.com

Hikvision Canada
T +1-866-200-6690
sales.canada@hikvision.com

Hikvision Thailand
T +662-275-9949
sales.thailand@hikvision.com

Hikvision Europe
T +31-23-5542770
sales.eu@hikvision.com

Hikvision Italy
T +39-0438-6902
info.it@hikvision.com

Hikvision Brazil
T +55 11 3318-0050
Latam.support@hikvision.com

Hikvision Turkey
T +90 (216)521 7070- 7074
sales.tr@hikvision.com

Hikvision Malaysia
T +601-7652-2413
sales.my@hikvision.com

Hikvision UK & Ireland
T +01628-902140
sales.uk@hikvision.com

Hikvision South Africa
Tel: +27 (10) 0351172
sale.africa@hikvision.com

Hikvision France
T +33(0)1-85-330-450
info.fr@hikvision.com

Hikvision Kazakhstan
T +7-727-9730667
nikia.panfilov@hikvision.ru

Hikvision Vietnam
T +84-974270888
sales.vt@hikvision.com

Hikvision UAE
T +971-4-4432090
salesme@hikvision.com

Hikvision Singapore
T +65-6684-4718
sg@hikvision.com

Hikvision Spain
T +34-91-737-16-55
info.es@hikvision.com

Hikvision Tashkent
T +99-87-1238-9438
uzb@hikvision.ru

Hikvision Hong Kong
T +852-2151-1761
info.hk@hikvision.com

Hikvision Russia
T +7-495-669-67-99
saleru@hikvision.com

Hikvision Korea
T +82-(0)31-731-8817
sales.korea@hikvision.com

Hikvision Poland
T +48-22-460-01-50
info.pl@hikvision.com

Hikvision Indonesia
T +62-21-2933759
Sales.Indonesia@hikvision.com

Hikvision Colombia
sales.colombia@hikvision.com