



2 MP Full Time Color Camera

User Manual

User Manual

Thank you for purchasing our product. If there are any questions, or requests, do not hesitate to contact the dealer.

This manual applies to the models below:

Type	Model
Type I Camera	DS-2CE12DF3T-LFS
Type II Camera	DS-2CE10DF3T-LPFS
	DS-2CE10DF3T-LFS
Type III Camera	DS-2CE72DF3T-LFS
Type IV Camera	DS-2CE70DF3T-LMFS
Type V Camera	DS-2CE70DF3T-LPFS

This manual may contain several technical mistakes or printing errors, and the content is subject to change without notice. The updates will be added to the new version of this manual. We will readily improve or update the products or procedures described in the manual.

01000020230713

Initiatives on the Use of Video Products

Thank you for choosing Hikvision products.

Technology affects every aspect of our life. As a high-tech company, we are increasingly aware of the role technology plays in improving business efficiency and quality of life, but at the same time, the potential harm of its improper usage. For example, video products are capable of recording real, complete and clear images. This provides a high value in retrospect and preserving real-time facts. However, it may also result in the infringement of a third party's legitimate rights and interests if improper distribution, use and/or processing of video data takes place. With the philosophy of "Technology for the Good", Hikvision requests that every end user of video technology and video products shall comply with all the applicable laws and regulations, as well as ethical customs, aiming to jointly create a better community.

Please read the following initiatives carefully:

1. Everyone has a reasonable expectation of privacy, and the installation of video products should not be in conflict with this reasonable expectation. Therefore, a warning notice shall be given in a reasonable and effective manner and clarify the monitoring range, when installing video products in public areas. For non-public areas, a third party's rights and interests shall be evaluated when installing video products, including but not limited to, installing video products only after obtaining the consent of the stakeholders, and not installing highly-invisible video products.
2. The purpose of video products is to record real activities within a specific time and space and under specific conditions. Therefore, every user shall first reasonably define his/her own rights in such specific scope, in order to avoid infringing on a third party's portraits, privacy or other legitimate rights.
3. During the use of video products, video image data derived from real scenes will continue to be generated, including a large amount of biological data (such as facial images), and the data could be further applied or reprocessed. Video products themselves could not distinguish good from bad regarding how to use the data based solely on the images captured by the video products. The result of data usage depends on the method and purpose of use of the data controllers. Therefore, data controllers shall not only comply with all the applicable laws and regulations and other normative requirements, but also respect international norms, social morality, good morals, common practices and other non-mandatory requirements, and respect individual privacy, portrait and other rights and interests.
4. The rights, values and other demands of various stakeholders should always be considered when processing video data that is continuously generated by video products. In this regard, product security and data security are extremely crucial. Therefore, every end user and data controller, shall undertake all reasonable and necessary measures to ensure data security and avoid data leakage, improper disclosure and improper use, including but not limited to, setting up access control, selecting a suitable network environment (the Internet or Intranet)

where video products are connected, establishing and constantly optimizing network security.

Video products have made great contributions to the improvement of social security around the world, and we believe that these products will also play an active role in more aspects of social life. Any abuse of video products in violation of human rights or leading to criminal activities are contrary to the original intent of technological innovation and product development. Therefore, each user shall establish an evaluation and tracking mechanism of their product application to ensure that every product is used in a proper and reasonable manner and with good faith.

About this Manual

The Manual includes instructions for using and managing the Product. Pictures, charts, images and all other information hereinafter are for description and explanation only. The information contained in the Manual is subject to change, without notice, due to firmware updates or other reasons. Please find the latest version of this Manual at the Hikvision website (<https://www.hikvision.com/>).

Please use this Manual with the guidance and assistance of professionals trained in supporting the Product.

Trademarks

HIKVISION and other Hikvision's trademarks and logos are the properties of Hikvision in various jurisdictions.

Other trademarks and logos mentioned are the properties of their respective owners.

Disclaimer

TO THE MAXIMUM EXTENT PERMITTED BY APPLICABLE LAW, THIS MANUAL AND THE PRODUCT DESCRIBED, WITH ITS HARDWARE, SOFTWARE AND FIRMWARE, ARE PROVIDED "AS IS" AND "WITH ALL FAULTS AND ERRORS". HIKVISION MAKES NO WARRANTIES, EXPRESS OR IMPLIED, INCLUDING WITHOUT LIMITATION, MERCHANTABILITY, SATISFACTORY QUALITY, OR FITNESS FOR A PARTICULAR PURPOSE. THE USE OF THE PRODUCT BY YOU IS AT YOUR OWN RISK. IN NO EVENT WILL HIKVISION BE LIABLE TO YOU FOR ANY SPECIAL, CONSEQUENTIAL, INCIDENTAL, OR INDIRECT DAMAGES, INCLUDING, AMONG OTHERS, DAMAGES FOR LOSS OF BUSINESS PROFITS, BUSINESS INTERRUPTION, OR LOSS OF DATA, CORRUPTION OF SYSTEMS, OR LOSS OF DOCUMENTATION, WHETHER BASED ON BREACH OF CONTRACT, TORT (INCLUDING NEGLIGENCE), PRODUCT LIABILITY, OR OTHERWISE, IN CONNECTION WITH THE USE OF THE PRODUCT, EVEN IF HIKVISION HAS BEEN ADVISED OF THE POSSIBILITY OF SUCH DAMAGES OR LOSS.

YOU ACKNOWLEDGE THAT THE NATURE OF THE INTERNET PROVIDES FOR INHERENT SECURITY RISKS, AND HIKVISION SHALL NOT TAKE ANY RESPONSIBILITIES FOR ABNORMAL OPERATION, PRIVACY LEAKAGE OR OTHER DAMAGES RESULTING FROM CYBER-ATTACK, HACKER ATTACK, VIRUS INFECTION, OR OTHER INTERNET SECURITY RISKS; HOWEVER, HIKVISION WILL PROVIDE TIMELY TECHNICAL SUPPORT IF REQUIRED.

YOU AGREE TO USE THIS PRODUCT IN COMPLIANCE WITH ALL APPLICABLE LAWS, AND YOU ARE SOLELY RESPONSIBLE FOR ENSURING THAT YOUR USE CONFORMS TO THE APPLICABLE LAW. ESPECIALLY, YOU ARE RESPONSIBLE, FOR USING THIS PRODUCT IN A MANNER THAT DOES NOT INFRINGE ON THE RIGHTS OF THIRD PARTIES, INCLUDING WITHOUT LIMITATION, RIGHTS OF PUBLICITY, INTELLECTUAL PROPERTY RIGHTS, OR DATA PROTECTION AND OTHER PRIVACY RIGHTS. YOU SHALL NOT USE THIS PRODUCT FOR ANY PROHIBITED END-USES, INCLUDING THE DEVELOPMENT OR PRODUCTION OF WEAPONS OF MASS DESTRUCTION, THE DEVELOPMENT OR PRODUCTION OF CHEMICAL OR BIOLOGICAL WEAPONS, ANY ACTIVITIES IN THE CONTEXT RELATED TO ANY NUCLEAR EXPLOSIVE OR

UNSAFE NUCLEAR FUEL-CYCLE, OR IN SUPPORT OF HUMAN RIGHTS ABUSES.

IN THE EVENT OF ANY CONFLICTS BETWEEN THIS MANUAL AND THE APPLICABLE LAW, THE LATTER PREVAILS.

Regulatory Information

EU Compliance Statement



This product and - if applicable - the supplied accessories too are marked with "CE" and comply therefore with the applicable harmonized European

standards listed under the Directive 2014/30/EU (EMCD) and Directive 2011/65/EU (RoHS).

Note: The products with the input voltage of within 50 to 1000 VAC or 75 to 1500 VDC comply with Directive 2014/35/EU (LVD), and the rest products comply with Directive 2001/95/EC (GPSD). Please check the specific power supply information for reference.



Directive 2012/19/EU (WEEE Directive):

Products marked with this symbol cannot be disposed of as unsorted municipal waste in the European Union. For proper recycling, return this product to your local supplier upon the purchase of equivalent

new equipment, or dispose of it at designated collection points. For more information see: www.recyclethis.info.



Directive 2006/66/EC and its amendment 2013/56/EU (Battery Directive): This product contains a battery that cannot be disposed of as unsorted municipal waste in the European Union. See the product

documentation for specific battery information. The battery is marked with this symbol, which may include lettering to indicate cadmium (Cd), lead (Pb), or mercury (Hg). For proper recycling, return the battery to your supplier or to a designated collection point. For more information see: www.recyclethis.info.

Industry Canada ICES-003 Compliance

This device meets the CAN ICES-3 (A)/NMB-3(A) standards requirements.

KC

A 급 기기: 이 기기는 업무용(A 급) 전자파적합기기로서 판매자 또는 사용자는 이 점을 주의하시기바라며, 가정 외의 지역에서 사용하는 것을 목적으로 합니다.

Warning

This is a class A product. In a domestic environment this product may cause radio interference in which case the user may be required to take adequate measures.



Safety Instruction

These instructions are intended to ensure that user can use the product correctly to avoid danger or property loss.

The precaution measure is divided into "Warnings" and "Cautions".

Warnings: Serious injury or death may occur if any of the warnings are neglected.

Cautions: Injury or equipment damage may occur if any of the cautions are neglected.

	
Warnings Follow these safeguards to prevent serious injury or death.	Cautions Follow these precautions to prevent potential injury or material damage.



Warnings

- In the use of the product, you must be in strict compliance with the electrical safety regulations of the nation and region.
- Input voltage should meet both the SELV (Safety Extra Low Voltage) and the Limited Power Source with 12 VDC according to the IEC60950-1 and IEC62368-1 standard. Refer to technical specifications for detailed information.
- The socket-outlet shall be installed near the equipment and shall be easily accessible.
- An all-pole mains switch shall be incorporated in the electrical installation of the building.
- Do not connect multiple devices to one power adapter to avoid over-heating or a fire hazard caused by overload.
- Make sure that the plug is firmly connected to the power socket.
- If smoke, odor or noise rise from the device, turn off the power at once and unplug the power cord, and then contact the service center.
- Never attempt to disassemble the camera by unprofessional personal.



Cautions

- No naked flame sources, such as lighted candles, should be placed on the equipment.
- Install the equipment according to the instructions in this manual.
- To prevent injury, this equipment must be securely attached to the floor/wall in accordance with the installation instructions.
- Do not drop the camera or subject it to physical shock.
- Do not touch sensor modules with fingers.
- Do not place the camera in extremely hot, cold (the operating temperature shall be -40°C to 60°C), dusty or damp locations, and do not expose it to high electromagnetic radiation.
- If cleaning is necessary, use clean cloth with a bit of ethanol and wipe it gently.
- Do not aim the camera at the sun or extra bright places.
- The sensor may be burned out by a laser beam, so when any laser equipment is in using, make sure that the surface of sensor will not be exposed to the laser beam.
- Do not expose the device to high electromagnetic radiation or extremely hot, cold, dusty or damp environment.

- To avoid heat accumulation, good ventilation is required for the operating environment.
- Keep the camera away from liquid while in use for non-water-proof device.
- While in delivery, the camera shall be packed in its original packing, or packing of the same texture.
- The beam of the light at the distance of 200 mm is classified as Risk Group 1 (RG1). Possible hazardous optical radiation emitted from this product.
- DO NOT stare at operating light source. May be harmful to the eyes.
- Wear appropriate eye protection or turn on the supplement light only at a safe distance (0.3 m) or in the area that is not directly exposed to the light when installing or maintaining the device.

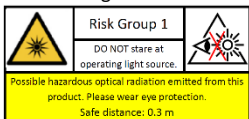

1 Introduction

1.1 Product Features

The main features are as follows:

- High performance CMOS sensor
- OSD menu with configurable parameters
- 24-hour color image
- Smart light
- 3-axis adjustment
- High quality audio with audio over coaxial cable, built-in mic

1.2 Overview

1.2.1 Overview of Type I Camera

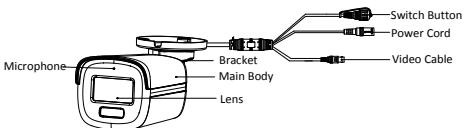

Figure 1-1 Overview of Type I Camera

Notes:

Press and hold the switch button for 5 seconds to switch the video output. Four kinds of video outputs are available: TVI, AHD, CVI, and CVBS.

1.2.2 Overview of Type II Camera

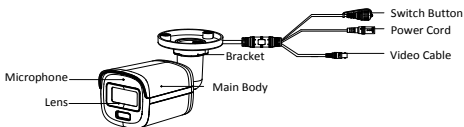

Figure 1-2 Overview of Type II Camera

Notes:

Press and hold the switch button for 5 seconds to switch the video output. Four kinds of video outputs are available: TVI, AHD, CVI, and CVBS.

1.2.3 Overview of Type III Camera

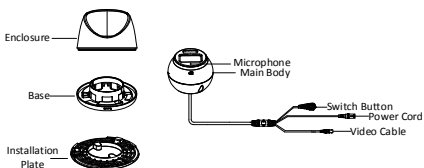

Figure 1-3 Overview of Type III Camera

Notes:

Press and hold the switch button for 5 seconds to switch the video output. Four kinds of video outputs are available: TVI, AHD, CVI, and CVBS

1.2.4 Overview of Type IV Camera

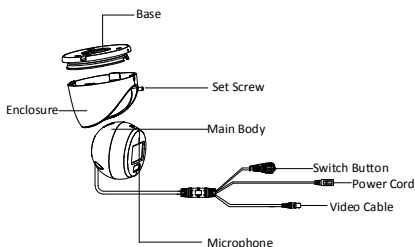

Figure 1-4 Overview of Type IV Camera

Notes:

Press and hold the switch button for 5 seconds to switch the video output. Four kinds of video outputs are available: TVI, AHD, CVI, and CVBS

1.2.5 Overview of Type V Camera

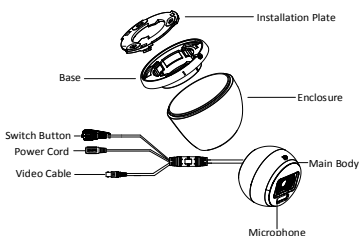

Figure 1-5 Overview of Type V Camera

Notes:

Press and hold the switch button for 5 seconds to switch the video output. Four kinds of video outputs are available: TVI, AHD, CVI, and CVBS

2 Installation

Before you start

- Make sure that the device in the package is in good condition and all the assembly parts are included.
- Make sure that all the related equipment is power-off during the installation.
- Check the specification of the products for the installation environment.
- Check whether the power supply is matched with your power output to avoid damage.
- Make sure the wall is strong enough to withstand three times the weight of the camera and the mount.

- If the product does not function properly, contact your dealer or the nearest service center. DO NOT disassemble the camera for repair or maintenance by yourself.

2.1 Installation of Type I and Type II Camera

Before you start:

The installation of type I and type II camera are similar. Following guide takes type I as example.

2.1.1 Ceiling/Wall Mounting without Junction Box

Steps:

1. Paste the drill template (supplied) to the installation location.
2. (Optional) For cement ceiling, drill the screw holes with a 5.5 mm drill and insert the supplied wall plugs.
3. (Optional) Drill the cable hole, when the cables are routed through the ceiling.
4. Secure the camera to ceiling with three PA4 × 25 screws (supplied).

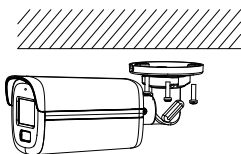

Figure 2-1 Secure the Camera to the Ceiling

5. Connect the power cord and video cable.
6. Power on the camera to adjust the view angle according to the figure below.

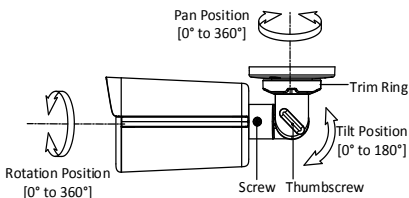

Figure 2-2 3-Axis Adjustment

2.1.2 Ceiling/Wall Mounting with Junction Box

Before you start:

- You need to purchase a junction box in advance.
 - Ceiling mounting and wall mounting are similar.
- Following steps take wall mounting as an example.

Steps:

1. Paste the drill template for junction box to the installation location.
2. (Optional) For cement wall, drill the screw holes with a 5.5 mm drill and insert the supplied wall plugs.
3. (Optional) Drill the cable hole, when the cables are routed through the wall.
4. Take apart the junction box.
5. Fix the camera to the junction box cover with three PM4 × 10 screws.

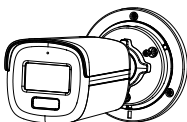

Figure 2-3 Fix the Camera to the Junction Box Cover

- Secure the junction box body on the wall with three PA4 × 25 screws (supplied).

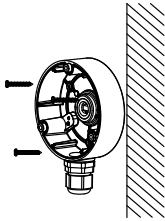

Figure 2-4 Secure the Junction Box on the Wall

- Route the cables through the bottom cable hole or side cable hole of the junction box and connect the cables.
- Fix the junction box cover on its body with three PM3 × 16 L6 screws.

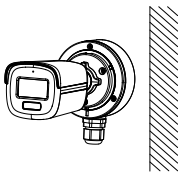

Figure 2-5 Fix the Cover to Its Body

- Refer **Step 6** of **Section 2.1.1** to finish installation.

2.2 Installation of Type III, Type IV and Type V Camera

Before you start:

The installation of type III, type IV and type V camera are similar. Following pictures are only for reference. Take the actual object as standard.

2.2.1 Ceiling Mounting without Junction Box

Steps:

- Paste the drill template (supplied) to the installation location.
- (Optional) For cement ceiling, drill the screw holes with a 5.5 mm drill and insert the supplied wall plugs.
- Install the camera to ceiling.
 - **For Type III and Type V camera:**
 - Secure the installation plate to the ceiling with three PA4 × 25 screws (supplied).
 - Fit the camera onto the installation plate.
 - Turn the camera as the figure below until it snaps into the installation plate.

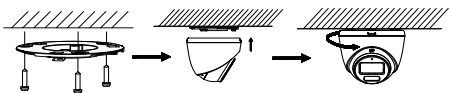

Figure 2-6 Install the Camera to Ceiling

- **For Type IV camera:**
 - Loosen the set screw.
 - Rotate the camera to align the triangle mark with the screw hole, and disassemble the camera.

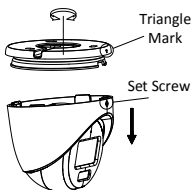

Figure 2-7 Disassemble the Camera

- iii. Secure the base to the ceiling with three PA4 × 25 screws (supplied).
- iv. Align the screw hole with the triangle mark to install the camera back to the base and secure it.

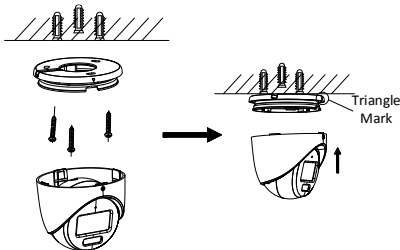

Figure 2-8 Install the Camera to Ceiling

4. Connect the power cord and video cable.
5. Power on the camera to adjust the view angle according to the figure below.

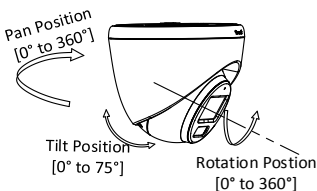

Figure 2-9 3-Axis Adjustment

- 1). Rotate the enclosure to adjust the pan position [0° to 360°].
- 2). Move the main body up and down to adjust the tilt position [0° to 75°].
- 3). Rotate the main body to adjust the rotation position [0° to 360°].

2.2.2 Ceiling Mounting with Junction Box

Before you start:

- You need to purchase a junction box in advance.
- Ceiling mounting with junction box and inclined ceiling mount are similar. Following steps take junction box as an example.

Steps:

1. Loosen screws to take apart the junction box.
2. Paste the drill template for junction box to the installation location.
3. (Optional) For cement ceiling, drill the screw holes with a 5.5 mm drill and insert the supplied wall plugs.
4. (Optional) Drill the cable hole, when the cables are routed through the ceiling.
5. Secure the junction box body on the ceiling with three or four PA4 × 25 screws according to the actual object.
6. Fix the camera to the junction box.
 - **For Type III camera:**

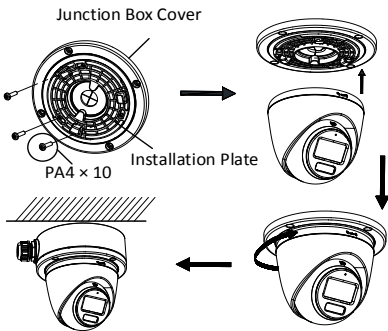

Figure 2-10 Fix the Camera to the Junction Box

● **For Type IV and Type V camera:**

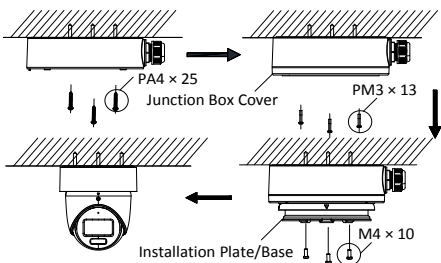

Figure 2-11 Fix the Camera to the Junction Box

7. Route the cables through the bottom cable hole or the side cable hole of the junction box.
8. Refer to **Step 5** of **Section 2.2.1** to adjust the angle and finish the installation.

2.2.3 Wall Mounting

Before you start:

You need to purchase a wall mount in advance.

Steps:

1. Drill $\varnothing 10$ mm screw holes in the wall where you want to install the wall mount.
2. Use four M6 expansion bolts to fix the wall mount onto the wall.

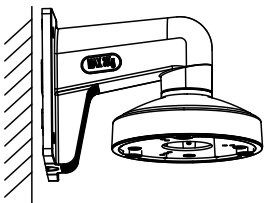

Figure 2-12 Fix the Wall Mount

3. Fix the base/installation plate to the wall mount.

● **For Type III and Type V camera:**

- i. Use three PM4 screws to fix the installation plate onto the wall mount.

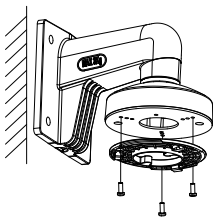

Figure 2-13 Fix the Installation Plate

● **For Type IV camera:**

- i. Refer to **Step 3** of Section **2.2.1** to disassemble the camera
- ii. Use M4 × 10 screws to fix the base onto the wall mount.

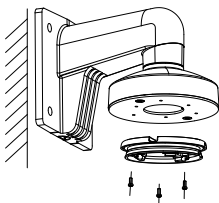

Figure 2-14 Fix the Base

4. Refer to **Steps 3 to 5** of Section **2.2.1** to finish installation.

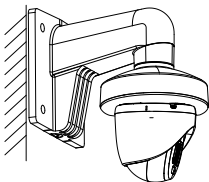

Figure 2-15 Finish Installation

3 Menu Description

Please follow the steps below to call the menu.

Note:

The actual display may vary with your camera model.

Steps:

1. Connect the camera with the TVI DVR and the monitor, as shown in figure 3-1.

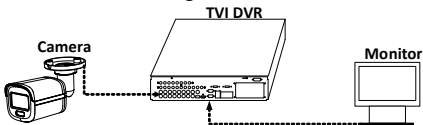



Figure 3-1 Connection

2. Power on the camera, TVI DVR, and monitor to view the image on the monitor.
3. Click PTZ Control to enter the PTZ Control interface.
4. Call the camera menu by clicking  button or calling preset No. 95.

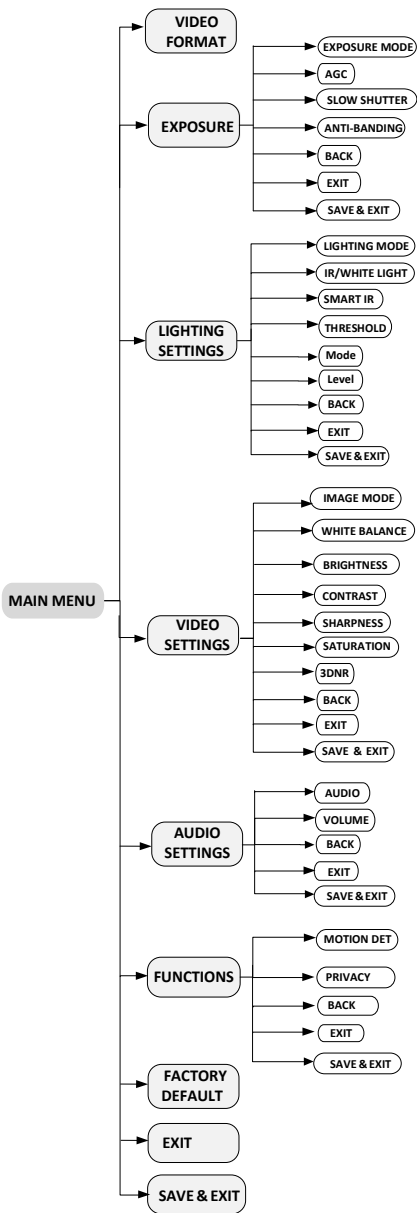

Figure 3-2 Main Menu Overview

5. Click the direction buttons to control the camera.
 - 1). Click up/down direction buttons to select menu options.
 - 2). Click Iris + to confirm the selection.
 - 3). Click left/right direction buttons to adjust the value of the selected option.

3.1 VIDEO FORMAT

Video formats are available as below.

Video Output	Video Format
TVI	2 MP@25 fps
AHD	2 MP@30 fps
CVI	PAL NTSC
CVBS	PAL NTSC

3.2 EXPOSURE

EXPOSURE MODE

You can set the **EXPOSURE MODE** to **GLOBAL**, **BLC**, **HLC**, **WDR**, or **HLS**.

- **GLOBAL**

GLOBAL refers to the normal exposure mode which adjusts lighting distribution, variations, and non-standard processing.

- **BLC (Backlight Compensation)**

BLC (Backlight Compensation) compensates light to the object in the front to make it clear, but this may cause over-exposure of the background where the light is strong.

- **HLC (Highlight Compensation)**

HLC stands for highlight compensation. The camera detects strong spots (over-exposure portion of image) and reduces the brightness of strong spots to improve the overall images.

- **WDR (Wide Dynamic Range)**

The wide dynamic range (**WDR**) function helps the camera provide clear images even under back light circumstances. When there are both very bright and very dark areas simultaneously in the field of view, **WDR** balances the brightness level of the whole image and provides clear detailed images.

- **HLS (Highlight Suppression)**

It is the same visual effect as the solar eclipse. If the brightness of a part in the image exceeds the threshold, this part will become black. Then whole image can be clear.

AGC (Auto Gain Control)

It optimizes the clarity of the image in poor light conditions. The **AGC** level can be set to **HIGH**, **MEDIUM**, or **LOW**.

Note:

The noise will be amplified when setting the **AGC** level.

SLOW SHUTTER

SLOW SHUTTER increases the exposure time on a single frame, which makes a camera more sensitive to the light so it can produce images even in low lux conditions.

ANTI-BANDING

ANTI-BANDING is to prevent the phenomenon of horizontal lines (banding) when photographing images in low frequency light or high brightness environments.

3.3 LIGHTING SETTINGS

LIGHTING MODE

IR and WHITE LIGHT are available.

- **IR**

- **IR LIGHT**

You can turn on/off the **IR LIGHT** to meet the requirements of different circumstances.

- **SMART IR**

The **Smart IR** function is used to adjust the light to its most suitable intensity, and prevent the image from over exposure.

- **D→N Threshold (Day to Night Threshold)**

Day to Night Threshold is used to control the sensitivity of switching the day mode to the night mode. You can set the value from 1 to 9. The larger the value is, the more sensitive the camera is.

- **N→D Threshold (Night to Day Threshold)**

Night to Day Threshold is used to control the sensitivity of switching the night mode to the day mode. You can set the value from 1 to 9. The larger the value is, the more sensitive the camera is.

➤ **WHITE LIGHT**

Under the **WHITE LIGHT** sub-menu, you can set the mode to **OFF** or **AUTO**.

- **OFF**

Set it to **OFF** to give up this function.

- **AUTO**

You can set **THRESHOLD** and **LEVEL** in this section.

THRESHOLD

The higher the threshold is, the more sensitive the device is to dark environment.

LEVEL

You can adjust the maximum brightness of supplement light.

MODE

The function is to reduce frame rate in low-light environment in order to increase SNR and enhance the brightness of the image.

- **MODE1:** Turn on the function.

- **MODE2:** Turn off the function.

3.4 VIDEO SETTINGS

Move the cursor to **VIDEO SETTINGS** and click Iris+ to enter the submenu. **IMAGE MODE**, **WHITE BALANCE**, **BRIGHTNESS**, **CONTRAST**, **SHARPNESS**, **SATURATION** and **3DNR** are adjustable.

VIDEO SETTINGS	
IMAGE MODE	◀ STD ▶
WHITE BALANCE	↵
BRIGHTNESS	◀ 5 ▶
CONTRAST	◀ 5 ▶
SHARPNESS	◀ 5 ▶
SATURATION	◀ 5 ▶
3DNR	◀ 5 ▶
BACK	↵
EXIT	↵
SAVE & EXIT	↵

Figure 3-3 VIDEO SETTINGS

IMAGE MODE

IMAGE MODE is used to adjust the image saturation, and you can set it to **STD** (Standard), **HIGH-SAT** (High Saturation), or **HIGHLIGHT** (better indoor facial details).

WHITE BALANCE

White balance, the white rendition function of the camera, is to adjust the color temperature according to the environment. It can remove unrealistic color casts in the image. You can set **WHITE BALANCE** mode to **AUTO**, or **MANUAL**.

- **AUTO**

Under **AUTO** mode, white balance is being adjusted automatically according to the color temperature of the scene illumination.

- **MANUAL**

You can set the **R-GAIN/B-GAIN** value to adjust the shades of red/blue color of the image.

WHITE BALANCE	
MODE	◀ MANUAL ▶
R-GAIN	◀ 5 ▶
B-GAIN	◀ 5 ▶
BACK	⏪
EXIT	⏪
SAVE&EXIT	⏪

Figure 3-4 WHITE BALANCE

BRIGHTNESS

Brightness refers to the brightness of the image. You can set the brightness value from 1 to 9 to darken or brighten the image. The greater the value is, the brighter the image is.

CONTRAST

This feature enhances the difference in color and light between parts of an image.

SHARPNESS

Sharpness determines the amount of detail an imaging system can reproduce.

SATURATION

Saturation is the proportion of pure chromatic color in the total color sensation. Adjust this feature to change the saturation of the color.

3DNR (3D DNR)

3DNR refers to 3D digital noise reduction. Comparing with the general 2D digital noise reduction, the 3D digital noise reduction function processes the noise between two frames besides processing the noise in one frame. The noise will be much less and the video will be clearer.

3.5 AUDIO SETTINGS

Note:

The function is only supported in TVI mode.

AUDIO

You can turn on or off the function under this sub-menu.

VOLUME

You can adjust the volume level under this sub-menu.

3.6 FUNCTIONS

MOTION DET

MOTION DET refers to motion detection. With motion detection feature, motion can be detected in any part of a camera's view. You can configure full screen or a number of zones in a camera's view where motion is to be detected.

PRIVACY

This function allows you to block or mask certain area of a scene to protect personal privacy from being recorded or live viewed. You can turn on/off the **PRIVACY** to meet your needs.

3.7 FACTORY DEFAULT

Reset all the settings to factory defaults.

3.8 EXIT

Move the cursor to **EXIT** and click Iris+ to exit the menu.

3.9 SAVE & EXIT

Move the cursor to **SAVE & EXIT** and click Iris+ to save the settings and exit the menu.

UD34216B