



Mobile Video Recorder

User Manual

Legal Information

©2023 Hangzhou Hikvision Digital Technology Co., Ltd. All rights reserved.

About this Manual

The Manual includes instructions for using and managing the Product. Pictures, charts, images and all other information hereinafter are for description and explanation only. The information contained in the Manual is subject to change, without notice, due to firmware updates or other reasons. Please find the latest version of this Manual at the Hikvision website (<https://www.hikvision.com/>).

Please use this Manual with the guidance and assistance of professionals trained in supporting the Product.

Trademarks

HIKVISION and other Hikvision's trademarks and logos are the properties of Hikvision in various jurisdictions. Other trademarks and logos mentioned are the properties of their respective owners.

Disclaimer

TO THE MAXIMUM EXTENT PERMITTED BY APPLICABLE LAW, THIS MANUAL AND THE PRODUCT DESCRIBED, WITH ITS HARDWARE, SOFTWARE AND FIRMWARE, ARE PROVIDED "AS IS" AND "WITH ALL FAULTS AND ERRORS". HIKVISION MAKES NO WARRANTIES, EXPRESS OR IMPLIED, INCLUDING WITHOUT LIMITATION, MERCHANTABILITY, SATISFACTORY QUALITY, OR FITNESS FOR A PARTICULAR PURPOSE. THE USE OF THE PRODUCT BY YOU IS AT YOUR OWN RISK. IN NO EVENT WILL HIKVISION BE LIABLE TO YOU FOR ANY SPECIAL, CONSEQUENTIAL, INCIDENTAL, OR INDIRECT DAMAGES, INCLUDING, AMONG OTHERS, DAMAGES FOR LOSS OF BUSINESS PROFITS, BUSINESS INTERRUPTION, OR LOSS OF DATA, CORRUPTION OF SYSTEMS, OR LOSS OF DOCUMENTATION, WHETHER BASED ON BREACH OF CONTRACT, TORT (INCLUDING NEGLIGENCE), PRODUCT LIABILITY, OR OTHERWISE, IN CONNECTION WITH THE USE OF THE PRODUCT, EVEN IF HIKVISION HAS BEEN ADVISED OF THE POSSIBILITY OF SUCH DAMAGES OR LOSS.

YOU ACKNOWLEDGE THAT THE NATURE OF THE INTERNET PROVIDES FOR INHERENT SECURITY RISKS, AND HIKVISION SHALL NOT TAKE ANY RESPONSIBILITIES FOR ABNORMAL OPERATION, PRIVACY LEAKAGE OR OTHER DAMAGES RESULTING FROM CYBER-ATTACK, HACKER ATTACK, VIRUS INFECTION, OR OTHER INTERNET SECURITY RISKS; HOWEVER, HIKVISION WILL PROVIDE TIMELY TECHNICAL SUPPORT IF REQUIRED.

YOU AGREE TO USE THIS PRODUCT IN COMPLIANCE WITH ALL APPLICABLE LAWS, AND YOU ARE SOLELY RESPONSIBLE FOR ENSURING THAT YOUR USE CONFORMS TO THE APPLICABLE LAW. ESPECIALLY, YOU ARE RESPONSIBLE, FOR USING THIS PRODUCT IN A MANNER THAT DOES NOT INFRINGE ON THE RIGHTS OF THIRD PARTIES, INCLUDING WITHOUT LIMITATION, RIGHTS OF PUBLICITY, INTELLECTUAL PROPERTY RIGHTS, OR DATA PROTECTION AND OTHER PRIVACY RIGHTS. YOU SHALL NOT USE THIS PRODUCT FOR ANY PROHIBITED END-USES, INCLUDING THE DEVELOPMENT OR PRODUCTION OF WEAPONS OF MASS DESTRUCTION, THE DEVELOPMENT OR PRODUCTION OF CHEMICAL OR BIOLOGICAL WEAPONS, ANY ACTIVITIES IN THE CONTEXT RELATED TO ANY NUCLEAR EXPLOSIVE OR UNSAFE NUCLEAR FUEL-CYCLE, OR IN SUPPORT OF HUMAN RIGHTS ABUSES.

IN THE EVENT OF ANY CONFLICTS BETWEEN THIS MANUAL AND THE APPLICABLE LAW, THE LATTER PREVAILS.

Regulatory Information

FCC Information

Please take attention that changes or modification not expressly approved by the party responsible for compliance could void the user's authority to operate the equipment.

FCC Compliance

This equipment has been tested and found to comply with the limits for a Class A digital device, pursuant to part 15 of the FCC Rules. These limits are designed to provide reasonable protection against harmful interference when the equipment is operated in a commercial environment. This equipment generates, uses, and can radiate radio frequency energy and, if not installed and used in accordance with the instruction manual, may cause harmful interference to radio communications. Operation of this equipment in a residential area is likely to cause harmful interference in which case the user will be required to correct the interference at his own expense.

FCC Conditions

This device complies with part 15 of the FCC Rules. Operation is subject to the following two conditions:

1. This device may not cause harmful interference.
2. This device must accept any interference received, including interference that may cause undesired operation.

EU Conformity Statement

 This product and - if applicable - the supplied accessories too are marked with "CE" and comply therefore with the applicable harmonized European standards listed under the EMC Directive 2014/30/EU, the LVD Directive 2014/35/EU, the RoHS Directive 2011/65/EU, RE Directive 2014/53/EU.

 2012/19/EU (WEEE directive): Products marked with this symbol cannot be disposed of as unsorted municipal waste in the European Union. For proper recycling, return this product to your local supplier upon the purchase of equivalent new equipment, or dispose of it at designated collection points. For more information see: www.recyclethis.info



 2006/66/EC (battery directive): This product contains a battery that cannot be disposed of as unsorted municipal waste in the European Union. See the product documentation for specific battery information. The battery is marked with this symbol, which may include lettering to indicate cadmium (Cd), lead (Pb), or mercury (Hg). For proper recycling, return the battery to your supplier or to a designated collection point. For more information see: www.recyclethis.info

Industry Canada ICES-003 Compliance

This device meets the CAN ICES-3 (A)/NMB-3(A) standards requirements.

Symbol Conventions

The symbols that may be found in this document are defined as follows.

Symbol	Description
 Note	Provides additional information to emphasize or supplement important points of the main text.
 Caution	Indicates a potentially hazardous situation, which if not avoided, could result in equipment damage, data loss, performance degradation, or unexpected results.
 Danger	Indicates a hazard with a high level of risk, which if not avoided, will result in death or serious injury.

Safety Instructions

- Proper configuration of all passwords and other security settings is the responsibility of the installer and/or end-user.
- In the use of the product, you must be in strict compliance with the electrical safety regulations of the nation and region. Please refer to technical specifications for detailed information.
- Input voltage should meet both the SELV (Safety Extra Low Voltage) and the Limited Power Source with 9 to 36 VDC according to the IEC60950-1 standard. Please refer to technical specifications for detailed information.

Note

It is recommended to use either 12 V or 24 V adapter when testing the device.

- Do not connect several devices to one power adapter as adapter overload may cause overheating or a fire hazard.
- Please make sure that the plug is firmly connected to the power socket.
- If smoke, odor or noise rise from the device, turn off the power at once and unplug the power cable, and then please contact the service center.

Preventive and Cautionary Tips

- Before connecting and operating your device, please be advised of the following tips:
- Ensure unit is installed in a well-ventilated, dust-free environment.
- Keep all liquids away from the device.
- Ensure environmental conditions meet factory specifications.

- Ensure unit is properly secured to a rack or shelf. Major shocks or jolts to the unit as a result of dropping it may cause damage to the sensitive electronics within the unit.
- Use the device in conjunction with an UPS if possible.
- Power down the unit before connecting and disconnecting accessories and peripherals.
- A factory recommended HDD should be used for this device.
- Improper use or replacement of the battery may result in hazard of explosion. Replace with the same or equivalent type only. Dispose of used batteries according to the instructions provided by the battery manufacturer.

TABLE OF CONTENTS

Chapter 1 Product Introduction.....	1
1.1 Introduction.....	1
1.2 Key Features.....	1
Chapter 2 Start Up Device	2
2.1 Activation	2
2.1.1 Default Information.....	2
2.1.2 Activate via Local Menu.....	2
2.1.3 Activate via SADP	2
2.1.4 Activate via Web Browser.....	3
2.2 Access Device via Web Browser.....	3
Chapter 3 Basic Operation.....	4
3.1 Configure Date & Time.....	4
3.2 Manage IP Camera.....	4
3.2.1 Activate IP Camera	4
3.2.2 Add IP Camera.....	5
3.2.3 Edit IP Camera.....	5
3.3 Record and Capture	5
3.3.1 Format Storage Media.....	5
3.3.2 Configure Continuous Recording.....	6
3.3.3 Configure Event Triggered Recording.....	6
3.3.4 Configure Disaster Storage	7
3.4 Playback	7
3.5 Back up.....	8
3.5.1 Back up Videos	8
3.5.2 Back Up Clipped Videos	8
3.5.3 Back up Pictures	9
Chapter 4 Network.....	10
4.1 Network Connection	10
4.1.1 Dial	10
4.1.2 Connect to Wi-Fi.....	11
4.1.3 Set Local Network.....	12
4.1.4 Configure Port.....	14
4.1.5 DDNS Configuration.....	14
4.1.6 Configure Priority	14
4.2 Platform Connection	14
4.2.1 Connect to Mobile Monitoring Platform	14
4.2.2 Connect to Guarding Vision	15
4.3 Network Sharing.....	16
4.3.1 Share Network via Wi-Fi AP	16
4.3.2 Share Network via Cable.....	16
Chapter 5 Live View and Configuration	17
5.1 Live View	17
5.1.1 Start/Stop Live View	17
5.1.2 Split Screen	17
5.1.3 Select Live View Stream.....	17

5.1.4 Manual Capture.....	17
5.1.5 Manual Recording	18
5.1.6 Start/Stop Two-Way Audio	18
5.1.7 Set Live View Volume	18
5.1.8 Full-Screen Live View	18
5.1.9 Channel-Zero.....	18
5.2 PTZ Operation.....	19
5.2.1 Configure PTZ.....	19
5.2.2 PTZ Control Panel	19
5.3 Local Configuration	20
Chapter 6 Mobile Device Features	22
6.1 Timed Shutdown.....	22
6.2 Delayed Shutdown.....	22
6.3 Configure Satellite Positioning.....	22
6.4 Configure G-Sensor Alarm	24
6.5 Configure Sensor-in.....	25
6.6 Configure Storage for Calamity.....	26
6.7 Configure Video Encryption.....	26
6.8 Configure Algorithm Mode.....	27
Chapter 7 Camera Management	28
7.1 Configure Encoding Parameters	28
7.2 Configure Audio Parameters	29
7.3 Image Settings	29
7.3.1 Set Image Parameters.....	29
7.3.2 Set Mirror Type	30
7.3.3 Restore Default Parameters.....	30
7.4 Set OSD Parameters	30
7.5 Set Privacy Mask.....	31
Chapter 8 Storage Settings	34
8.1 Record Schedule	34
8.2 Storage Management.....	36
8.2.1 HDD Management.....	36
8.2.2 HDD Detection	36
8.3 Advanced Settings.....	38
Chapter 9 Smart Functions	40
9.1 Driving Behavior Configuration.....	40
9.1.1 Configuration	40
9.1.2 Play Videos and Pictures.....	41
9.2 ADAS Setting.....	42
9.2.1 Calibrate ADAS	42
9.2.2 ADAS Eevent	44
9.3 BSD Setting.....	47
9.3.1 Calibrate BSD Area	47
9.3.2 Blind Spot Detection.....	48
Chapter 10 Events and Alarms.....	50
10.1 Configure Motion Detection Alarm.....	50
10.2 Configure Video Tampering Alarm.....	50

10.3 Configure Video Loss Alarm.....	51
10.4 Configure Alarm Input.....	51
10.5 Configure Alarm Output.....	52
10.6 Configure Exception Alarm.....	53
10.7 Configure Driving Behaviors Alarm.....	53
10.8 Configure ADAS Alarm.....	54
10.9 Configure Blind Spot Detection Alarm.....	55
10.10 Configure Arming Schedule.....	55
10.11 Configure Linkage Actions.....	55
Chapter 11 User Management.....	57
11.1 Manage User Account.....	57
11.2 Configure Security Question.....	57
Chapter 12 Security.....	58
12.1 Configure Allowlist.....	58
12.2 Configure SSH.....	58
Chapter 13 Maintenance.....	59
13.1 View System Information.....	59
13.2 Search Log File.....	59
13.3 Upgrade the System.....	59
13.4 Configure Image Partition.....	59
13.5 Configure Overwritten Recording.....	60
13.6 Print Log.....	60
13.7 Rebooting.....	60
13.8 Restore Default Settings.....	60
13.9 Export Configuration File.....	60
13.10 Import Configuration File.....	61
13.11 Configure DST Settings.....	61
13.12 Synchronize Time.....	61
13.13 Configure Menu Output.....	61
13.14 Configure RS-232.....	62
Chapter 14 Local Menu Operation.....	63
14.1 Manage IP Camera.....	63
14.1.1 Activate IP Camera.....	63
14.1.2 Add IP Camera.....	63
14.1.3 Edit IP Camera.....	64
14.2 Recording.....	64
14.2.1 Format Storage Media.....	64
14.2.2 Configure Recording Schedule.....	64
14.3 Playback.....	65
14.4 Back up.....	65
14.5 Preview Settings.....	66
Chapter 15 Configure Smart Functions on ADAS APP.....	67
15.1 Install the ADAS APP.....	67
15.2 Configure Wi-Fi AP.....	67
15.3 Configure Smart Settings.....	68
15.4 ADAS Settings.....	70
15.4.1 ADAS Parameter Settings.....	70

15.4.2 Camera Settings	72
15.4.3 Video Settings	76
15.4.4 Recording Schedule Settings.....	76
15.5 DBA Settings	78
15.5.1 DBA Parameter Settings.....	78
15.5.2 Video and Recording Schedule Settings.....	80
15.6 BSD Settings.....	80
15.6.1 BSD Parameter Settings	80
15.6.2 Advanced Settings	81
15.6.3 Calibration Detection Area.....	82
15.6.4 Video and Recording Schedule Settings.....	84

Chapter 1 Product Introduction

1.1 Introduction

Adopting embedded Linux operating system, mobile video recorder (hereinafter referred to as the recorder) provides powerful monitoring functions. It can both work alone as a recorder and cooperate with other devices to build a comprehensive monitoring system. The recorder is widely applied to the monitoring projects of public transportation, school bus, etc.

1.2 Key Features

- User-friendly GUI providing easy and flexible operations.
- Pluggable 3G/4G module and built-in Wi-Fi module providing flexible data transmission solutions.
- Information collection interfaces collecting driving information such as left/right turn, braking, reversing, etc.
- Specialized aviation connectors ensuring signal stability.
- Ignition startup and delay (0 to 6h) shutdown.
- Battery protection avoids vehicle from running out of battery.
- Wide-range power input (+ 9 to + 32 VDC).
- Power-off protection avoids key data from loss.
- Tensile aluminum chassis with no fan design well adaptable to working environment.
- Software-based firewall supported.
- GNSS (Global Navigation Satellite System) module precisely positioning the vehicle via the satellite and recording the location information in the stream.

Chapter 2 Start Up Device

2.1 Activation

You can activate the recorder via the SADP software, the Web, the client software or the local menu.

If you want to activate the device via the SADP software or the Web, make sure that the device and your computer are in the same network segment.

If you want to activate the recorder via the local menu, you must connect the device to an external monitor.

For the first-time access, you need to activate the recorder by setting an admin password. No operation is allowed before activation.

2.1.1 Default Information

The default setting of the recorder is as follows:

- Default IP: 192.168.1.64.
- Default user name: admin.

2.1.2 Activate via Local Menu

You can activate the recorder via the local menu when it's connected to an external monitor.

Step 1 Enter the same password in **Password** and **Confirm Password**.

Note

We highly recommend you to create a strong password of your own choosing (using a minimum of 8 characters, including at least three kinds of following categories: upper case letters, lower case letters, numbers, and special characters) in order to increase the security of your product. And we recommend you reset your password regularly, especially in the high security system, resetting the password monthly or weekly can better protect your product.

Step 2 Click **OK**.

2.1.3 Activate via SADP

SADP software is used for detecting the online device, activating the device, and resetting the password. Get the SADP software from the supplied disk or the official website, and install the SADP according to the prompts. Follow the steps to activate the camera.

Before You Start

- Ensure your computer and the recorder are in the same network segment.
- Install the SADP software in your computer.

Step 1 Run the SADP software.

Step 2 Check the recorder status from the device list, and select the inactive recorder.

 **Note**

We highly recommend you to create a strong password of your own choosing (using a minimum of 8 characters, including at least three kinds of following categories: upper case letters, lower case letters, numbers, and special characters) in order to increase the security of your product. And we recommend you reset your password regularly, especially in the high security system, resetting the password monthly or weekly can better protect your product.

Step 3 Enter the same password in **Password** and **Confirm Password**.

Step 4 Click **Activate**.

2.1.4 Activate via Web Browser

You can activate the device via a web browser.

Before You Start

Ensure your computer and the recorder are in the same network segment.

Step 1 Open web browser, input the IP address of the device and then press Enter.

 **Note**

We highly recommend you to create a strong password of your own choosing (using a minimum of 8 characters, including at least three kinds of following categories: upper case letters, lower case letters, numbers, and special characters) in order to increase the security of your product. And we recommend you reset your password regularly, especially in the high security system, resetting the password monthly or weekly can better protect your product.

Step 2 Enter the same password in **Password** and **Confirm**.

Step 3 Click **OK**.

2.2 Access Device via Web Browser

Login without plug-in only supports configuration, not preview and playback.

Step 1 Visit the IP address of the device via web browser.

Step 2 Enter the user name and password.

Step 3 Click **Login**.

 **Note**

Follow the installation prompts to install the plug-in before other operations.

What to do next

Click **Logout** in top right corner to log out the recorder.

Chapter 3 Basic Operation

You can perform the basic operations once the recorder is connected to an IP camera.

3.1 Configure Date & Time

Configure time zone and time synchronization mode.

Step 1 Go to **Configuration > System > System Settings > Time Settings**.

Step 2 Select Time Zone according to the recorder location.

Step 3 Select time synchronization mode as NTP or Manual Time Sync.

- 1) If an NTP server is available, select **NTP** and enter NTP server information to synchronize NTP server time to your recorder.
- 2) Select **Manual Time Sync.** and set time to customize the recorder time.
- 3) Select **Manual Time Sync.** and check **Sync. with computer time** to synchronize the computer time to your recorder.

Step 4 Click **Save**.

3.2 Manage IP Camera

The section is only available for the recorder that supports network camera.

3.2.1 Activate IP Camera

Before adding an IP camera, activate it by setting a password for it.

Step 1 Go to **Configuration > System > Camera Management > IP Camera**.

Step 2 Select an inactivated IP camera.

Note

We highly recommend you to create a strong password of your own choosing (using a minimum of 8 characters, including at least three kinds of following categories: upper case letters, lower case letters, numbers, and special characters) in order to increase the security of your product. And we recommend you reset your password regularly, especially in the high security system, resetting the password monthly or weekly can better protect your product.

Step 3 Click **Activation**.

Step 4 Enter the same password in **New Password** and **Confirm**.

Step 5 Click **OK**.

3.2.2 Add IP Camera

You can add the activated IP cameras. Ensure the device and IP cameras are in the same network segment.

Before You Start

The recorder and the camera to add must be in the same network segment.

Step 1 Go to **Configuration > System > Camera Management > IP Camera**.

Step 2 Optional: If the recorder and the camera are in different network segment, modify IP camera address.

- 1) Check the IP camera and click **Modify**.
- 2) Enter **IP Address** and **Password**.
- 3) Click **OK**.

Step 3 Select a camera and click **Add**.



If the recorder password is the same with the camera's, click **Quick Add** to add the camera.

Step 4 Enter IP camera information.

Step 5 Click **OK**.

3.2.3 Edit IP Camera

You can visit, delete, and modify the added IP cameras.

Before You Start

If the recorder contains only one network card, you can visit IP camera via the recorder. If the recorder contains dual network card, you need to enable virtual host function before visiting IP camera via the recorder. Go to **Configuration > Network > Advanced Settings > Other** and check **Enable Virtual Host**.

Step 1 Go to **Configuration > System > Camera Management > IP Camera**.

Step 2 Optional: Click address of IP camera to visit.

Step 3 Optional: Check IP cameras and click **Delete** to delete added IP cameras.

3.3 Record and Capture

To record the videos for connected cameras, you need to install a storage media and format it, and configure the recording schedule.

3.3.1 Format Storage Media

A newly installed storage media must be initialized before it can be used.

Before You Start

Install a storage media.

Step 1 Go to **Configuration > Storage > Storage Management**.

Step 2 Check the storage media and click **Format**.

Result

After format, the storage media status should be **Normal**.

3.3.2 Configure Continuous Recording

The recorder is configured with all-day continuous recording by default.

Before You Start

Install and format a storage media.

Step 1 Go to **Configuration > Storage > Schedule Settings**.

Step 2 Select **Channel No.**

Step 3 Check **Enable**.

Step 4 Select recording type as **Continuous**.

Step 5 Optional: Click **Advanced** to configure Pre-record and Post-record.

Pre-record

The time you set to start recording before the scheduled time or the event. For example, if an alarm triggers recording at 10:00, and the pre-record time is set as 5 seconds, the device starts to record at 9:59:55.

Post-record

The time you set to stop recording after the scheduled time or the event. For example, if an alarm triggered recording ends at 11:00, and the post-record time is set as 5 seconds, the device records until 11:00:05.

Step 6 Set recording schedule. For detailed steps, refer to *Configure Arming Schedule*.

Step 7 **Optional**: Click **Copy to** to copy upper settings to other channel.

Step 8 Click **Save**.

3.3.3 Configure Event Triggered Recording

Trigger recording when an event is triggered.

Before You Start

- Install and format the storage media.
- Configure event parameters. For details, refer to *Events and Alarms*.

Step 1 **Go to Configuration > Storage > Schedule Settings**.

Step 2 Select **Channel No.**

Step 3 Check **Enable**.

Step 4 Select recording type as Motion | Alarm, Alarm, Motion, or Motion & Alarm.

Motion | Alarm

Trigger recording when either motion detection or alarm input is detected.

Alarm

Trigger recording when alarm input is detected.

Motion

Trigger recording when either motion detection detected.

Motion & Alarm

Trigger recording when both motion detection and alarm input are detected.

Step 5 Optional: Click Advanced to configure Pre-record and Post-record.

Pre-record

The time you set to start recording before the scheduled time or the event. For example, if an alarm triggers recording at 10:00, and the pre-record time is set as 5 seconds, the device starts to record at 9:59:55.

Post-record

The time you set to stop recording after the scheduled time or the event. For example, if an alarm triggered recording ends at 11:00, and the post-record time is set as 5 seconds, the device records until 11:00:05.

Step 6 Set recording schedule. For detailed steps, refer to *Configure Arming Schedule*.

Step 7 **Optional:** Click **Copy to** to copy upper settings to other channel.

Step 8 Click **Save**.

3.3.4 Configure Disaster Storage

The function is only available for recorder supporting mobile fireproof storage box. The recorder will save videos in both HDD and mobile fireproof storage box to ensure data security.

Before You Start

- Connect a mobile fireproof storage box to your recorder.
- Configure the recording schedule.

Step 1 Go to **Configuration > Vehicle > Storage For Calamity**.

Step 2 Check **Enable**.

Step 3 Check **Redundant Channel**. The recorder will save the videos of the selected channels in both HDD and mobile fireproof storage box.

Step 4 Click **Save**.

3.4 Playback

Play videos saved in storage media.

Step 1 Go to **Playback**.

Step 2 Select a channel in channel list.

Step 3 Select playback type.

- To search all the videos, select **Ordinary Search**.
- To search event videos, select **Event Search**.

Step 4 Set search conditions.

Step 5 Click **Search**.











Step 6 Click  to start playback.

Table 3-1 Playback Options

Icon	Description	Icon	Description
	Pause.		Single frame playback.
	Fast forward.		Slow forward.
	Stop all playbacks.		Capture a picture.
			 Note For picture saving path, refer to Configuration > Local > Save snapshots when playback to.
	Turn on audio.		Full screen.

3.5 Back up

3.5.1 Back up Videos

Download videos to a local path.

Step 1 Go to **Playback**.

Step 2 Click .

Step 3 Set search conditions.

Step 4 Click **Search**.

Step 5 Check videos to download and click **Download**.

Step 6 For the video saving path, refer to **Configuration > Local > Save Downloaded Files to**.

3.5.2 Back Up Clipped Videos

Clip videos and save them to a local path.

Step 1 Go to **Playback**.

Step 2 Start playback.

Step 3 Click  to start clipping.

Step 4 Click  to stop clipping.

Step 5 For clipped video saving path, refer to **Configuration > Local > Save clips to**.

3.5.3 Back up Pictures

Back up pictures to a local path.

Step 1 Go to **Picture**.

Step 2 Set search conditions.

Step 3 Click **Search**.

Step 4 Check pictures to download.

Step 5 Click **Download**.

 **Note**

For picture saving path, refer to Configuration > Local > Picture and Clip Settings.

Chapter 4 Network

4.1 Network Connection

4.1.1 Dial

Set the dialing parameters if you want to connect the device to the network via dialing.

Before You Start

Install SIM card and connect 3G/4G antenna to your device.

Step 1 Go to **Configuration > Network > Basic Settings > 3G/4G**.

Step 2 Check **Enable**.

Step 3 Click **Dial Parameters**.

Step 4 Select **Network Mode**.

- Automatic:

The recorder will automatically switch to the strongest network.

- Auto-Search and Auto-Switch:

Network priority: 4G > 3G > 2G. The recorder will automatically connect the network of high priority.

- 3G

The recorder only connects 3G network.

- 4G

The recorder only connects 4G network.

Step 5 **Optional**: To connect private network, enter **Access Number, User Name, Password, and APN**.

TCP/IP DDNS Port **3G/4G** Priority

Modules Choise ▾

Enable

Wireless Dial-up Status **Dial Parameters**

Dial Mode ▾

Network Mode ▾

Access Number

User Name 

Password

APN

MTU

Verification Protocol ▾

[The default load](#)



Figure 4-1 Set Dial Parameters

Step 6 Click **Save**.

Step 7 **Optional:** Click **Wireless Dial-up Status** to view dialing status.

4.1.2 Connect to Wi-Fi

Configure Wi-Fi parameters to connect the device to the network via Wi-Fi.

Step 1 Go to **Configuration > Network > Basic Settings > TCP/IP**.

Step 2 Set WLAN parameters.

- 1) Click **WLAN 1**.
- 2) **Optional:** Check **DHCP**. Use SADP tool to obtain the recorder IP address when DHCP is enabled.

 **Note**

If you want to enable DHCP, the network that the device is connected to should support DHCP (Dynamic Host Configuration Protocol).

- 3) Enter wireless network **IPv4 Address, IPv4 Subnet Mask, IPv4 Default Gateway, and DNS Server.**
- 4) Click **Save.**

Step 3 Go to **Configuration > Network > Advanced Settings > Wi-Fi.**

- 1) Click **Wi-Fi Configuration.**
- 2) Check **Enable Wi-Fi.**
- 3) Click **Search** to search available wireless networks.
- 4) Select a wireless network in **Wireless List.**
- 5) Enter **SSID.**
- 6) Select **Network Mode** as **Managed.**
- 7) Select **Security Mode** and enter Wi-Fi key.

Step 4 Click **Save.**

Step 5 Optional: Go to **Configuration > Network > Advanced Settings > Wi-Fi > Wi-Fi Status** to view Wi-Fi status.

4.1.3 Set Local Network

Configure local network parameters.

Step 1 Go to **Configuration > Network > Basic Settings > TCP/IP.**

Step 2 Click **Lan.**

TCP/IP DDNS Port 3G/4G Priority

Lan WLan1

Lan Choice Debug Interface ▾

NIC Type Auto ▾

IPv4 Address 10.67.193.206

IPv4 Subnet Mask 255.255.255.0

IPv4 Default Gateway 10.67.193.254

MAC Address 00:00:00:00:00:00

MTU 1500

DNS Server

Preferred DNS Server 0.0.0.0

Alternate DNS Server 0.0.0.0

Network Share

Enable Network Share

 Save

Figure 4-2 Configure Local Network

Step 3 Select LAN Choice.

- Debug Interface: Used to debug the recorder.
- Front Interface: Used to connect network cameras.

 **Note**

Do not set the debug and rear net to the same network segment. Otherwise, it will lead to conflict.

Step 4 Enter network parameters: IPv4 Address, IPv4 Subnet Mask, and IPv4 Default Gateway.

Step 5 Optional: To access the recorder via internet, configure DNS server.

Step 6 Click **Save**.

4.1.4 Configure Port

Go to **Configuration > Network > Basic Settings > Port** to set the following parameters.

HTTP Port

To access the recorder via web browser.

RTSP Port

To get stream.

HTTPS Port

To secure communication over a network.

Server Port

To access the recorder via client software.

4.1.5 DDNS Configuration

If your recorder external network is a dynamic IP address, you can use the Dynamic DNS (DDNS) for network access.

Before You Start

- Register your recorder on the DDNS server.
- Configure local network IP address, subnet mask, gateway, and DNS server.
- Create port mapping, default port: 80, 8000, and 554.

Step 1 Go to **Configuration > Network > Basic Settings > DDNS**.

Step 2 Select DDNS Type.

Step 3 Enter server information.

Step 4 Click **Save**.

What to do next

Open the web browser and enter the recorder domain name to visit it.

4.1.6 Configure Priority

The device will automatically connect network of high priority.

Step 1 Go to **Configuration > Network > Basic Settings > Priority**.

Step 2 Check **Enable NetPriority**.

Step 3 Set the priority of the network.

4.2 Platform Connection

4.2.1 Connect to Mobile Monitoring Platform

The device can be remotely accessed via mobile monitoring platform.

Before You Start

Create the device ID on mobile monitoring platform.

Step 1 Go to **Configuration > Network > Advanced Settings > Platform Access**.

Step 2 Check **Enable**.

Step 3 Select **Platform Access Mode** as Ehome Platform.

Step 4 Select **Platform Version**.

Step 5 Select **Server Address Type**, and enter Server Address, Server Port, and Device ID.

Server Address

Enter the static IP address of mobile monitoring platform.

Server Port

The default value is 7660.

Device ID

The ID of the device registered on the mobile monitoring platform. If you leave it empty, device logs in to the platform with serial No.

Step 6 Click **OK**.

4.2.2 Connect to Guarding Vision

The device can be remotely accessed via guarding vision platform.

Before You Start

- Connect your recorder to internet.
- Configure IP address, sub-netmask, gateway, and DNS server of LAN port.

Step 1 Go to **Configuration > Network > Advanced Settings > Platform Access**.

Step 2 Check **Enable**.

Step 3 Select **Platform Access Mode** as **Guarding Vision**.

Step 4 Enter a customized **Security Code**. You need to enter the security code when adding the device in **Guarding Vision**.

Valid security code range [6-12]. You can use a combination of numbers, lowercase, and uppercase.

Step 5 Click **Save**.

Step 6 Visit guarding vision platform.

- For computer user: Visit dev.Quardingvision.com.
- For mobile phone user: Download Guarding Vision application in App Store (iOS system) or Google Play(TM) (Android system).

Step 7 Register an account.

Step 8 Add the recorder by its serial number (a 9-bit character printed in device label) and security code.

Step 9 Start live view of your camera.

4.3 Network Sharing

4.3.1 Share Network via Wi-Fi AP

The recorder can work as a wireless router, via which -other devices can access via the network.

 **Note**

You can only turn on one function between Wi-Fi AP and Wi-Fi. Turning on one of them will turn off the other.

Step 1 Go to **Configuration > Network > Advanced Settings > Wi-Fi AP**.

Step 2 Check **Enable Wi-Fi AP**, **Enable AP Broadcast**, and **Enable WLAN HotSpot**.

Step 3 Configure hotspot parameters.

- 1) Enter **SSID** (hotspot name).
- 2) Select **Security Mode**.
- 3) Enter **IP Address** and **Sub-net Mask**.

 **Note**

The IP address must be in different network segment with TCP/IP address.

Step 4 Check **Enable DHCP** and enter Start IP Address and End IP Address.

Step 5 Click **Save**.

4.3.2 Share Network via Cable

Connect a peripheral device to your recorder with a network cable. The peripheral device can access internet after the recorder successfully dialed to internet.

Before You Start

Configure the IP address, gateway, etc. of the peripheral device.

Step 1 Go to **Configuration > Network > Basic Settings > TCP/IP > Lan**.

Step 2 Check **Enable Network Share**.

Step 3 Configure the network parameters for the peripheral device.

- 1) Set its IP address in the same network segment with your recorder.
- 2) Set its network gateway IP as the recorder IP address.

Step 4 Click **Save**.

The peripheral device can access internet after the recorder successfully dialed to internet.

Chapter 5 Live View and Configuration

5.1 Live View

5.1.1 Start/Stop Live View

Start/stop the live view of cameras.

Step 1 Go to **Live View**.

Step 2 Click  to select window division and click to select a window to display the live view image.

Step 3 Double click a camera in the camera list to display its live image in selected window. Or click  to start the live view of all cameras.

Step 4 Double click the camera again to stop its live view. Or click  to stop the live view of all cameras.



5.1.2 Split Screen

Live view window division is selectable.

Window Division

Click  to select live view window division.

Paging

Click  /  to turn to previous/next window.

5.1.3 Select Live View Stream

The recorder supports main stream and sub-stream. Main stream is used for continuous recording and sub-stream is used for network transmission.

Click  in camera list to select live view stream.

5.1.4 Manual Capture

Capture live view pictures and save them to your computer.

Step 1 Go to **Live View**.

Step 2 Start live view of a camera.

Step 3 Click .

Step 4 View captured pictures.

- Enter the path popped up in the lower right corner.
- Go to **Configuration > Local > Picture and Clip Settings** for the saving path of captured pictures.

5.1.5 Manual Recording

Record videos in live view and save them to your computer.

Step 1 Go to **Live View**.

Step 2 Start live view of a camera.

Step 3 Click  to start recording.

Step 4 Click  to stop recording.

Step 5 Go to the set saving path to view recorded videos.

- Enter the path popped up in the lower right corner of the interface.
- Go to **Configuration > Local > Record File Settings** for the saving path of record files.

5.1.6 Start/Stop Two-Way Audio

You can have real-time two-way audio between your computer and the recorder.

Before You Start

Connect the audio input and output devices to the recorder and computer.

Step 1 Start the live view of a camera.

Step 2 Click .

Result

- At computer end, you can hear the audio from recorder.
- At recorder end, you can hear the audio from computer.

5.1.7 Set Live View Volume

Turn on audio and adjust audio volume.

Click  to turn on audio.

Drag the slider to adjust volume.

5.1.8 Full-Screen Live View

Display the live view image in full screen.

Start the live view and click  to display the live view image in full screen.

Press **Esc** to exit from the full-screen mode.

5.1.9 Channel-Zero

Channel-zero, known as virtual channel, can show the videos from all channels of the recorder, reducing the bandwidth while simultaneously previewing from multi-channel.

Step 1 Go to **Configuration > Video/Audio > Channel-zero**.

Step 2 Check **Enable Channel-zero Encoding**.

Step 3 Select **Max. Bitrate** and **Max. Frame Rate**.

Step 4 Click **Save**.

Step 5 Go to **Live View**.

Step 6 Double click **Zero Channel 01** in the camera list to start live view of channel-zero.

5.2 PTZ Operation

Configure PTZ parameters and control PTZ.

5.2.1 Configure PTZ

Follow the steps to set PTZ parameters. The configuration of the PTZ parameters should be done before you control the PTZ camera.

Before You Start

Connect the RS-485 cables of the PTZ camera to EXT.DEV interface of the device.

Step 1 Go to **Configuration > System > System Settings > PTZ Config**.

Step 2 Select **Channel No.** of PTZ camera.

Step 3 Configure the parameters of the PTZ camera.

Note

All the parameters should be exactly the same with those of the PTZ camera.

Step 4 Click **Save**.











5.2.2 PTZ Control Panel

Go to **Live View**. Control PTZ camera via PTZ panel.

Note

PTZ control panel may vary with recorder model.

Table 5-1 PTZ Icon and Description

Icon	Description	Icon	Description
	Direction buttons.		Auto-scan button.
	Zoom -.		Zoom +.
	Focus +.		Focus -.
	Iris +.		Iris -.
	Turn on /off light.		Start/stop wiper.

5.3 Local Configuration

Go to **Configuration > Local** to configure the parameters of live view, record files, pictures, and clips.

Table 5-2 Local Configurations

Options	Descriptions
Stream Type	<p>Main Stream: The stream stands for the best stream performance the device supports. It usually offers the best resolution and frame rate the device can do. But high resolution and frame rate usually means larger storage space and higher bandwidth requirements in transmission.</p> <p>Sub Stream: The stream usually offers comparatively low resolution options, which consumes less bandwidth and storage space.</p>
Play Performance	<p>Shortest Delay: The recorder ensures real-time capacity in priority.</p> <p>Auto: Automatically adjust the live view stream to balance real-time capacity and fluency.</p>
Rules	If you enable the function, after the connected camera has been set motion detection alarm and enabled VCA function, the rule information will be displayed on the live view image (e.g., marked with a green rectangle).
Image Size	Select the image aspect ratio.
Auto Start Live View	Select Yes if you want to enable live view automatically after login.
Image Format	Select the captured picture format in live view.
Record File Size	Select the packed size of the manually recorded and downloaded video files. After the selection, the maximum record file size is the value you selected.
Save record files to	Set the saving path for the manually recorded video files. You can click Browse to change the saving path.

Save downloaded files to	Set the saving path for the downloaded video files. You can click Browse to change the saving path.
Save snapshots in live view to	Set the saving path for the manually captured pictures in live view mode. You can click Browse to change the saving path.
Save snapshots when playback to	Set the saving path for the manually captured pictures in playback mode. You can click Browse to change the saving path.
Save clips to	Set the saving path for the clipped video files in playback mode. You can click Browse to change the saving path.

Chapter 6 Mobile Device Features

6.1 Timed Shutdown

The recorder will automatically start up/shut down according the schedule.

Before You Start

Wire power cord. For details, refer to the Quick Start Guide.

Step 1 Go to **Configuration > Vehicle > Startup**.

Step 2 Select **Auto Work Type** as Scheduled Startup/shutdown.

Step 3 Set the shutdown schedule. For detailed steps, refer to *Configure Arming Schedule*.

Step 4 Optional: Check Low Power Protect and select Low Power Protect Limit. If the voltage of the recorder reaches the selected threshold, the recorder will shut down automatically.

Step 5 Click **Save**.

6.2 Delayed Shutdown

You can set the shutdown delay time (Vehicle Ignition Startup and Shutdown) for the recorder.

Before You Start

Wire power cord. For details, refer to quick start guide.

Step 1 Go to **Configuration > Vehicle > Startup**.

Step 2 Select **Auto Work Type** as **Halt Delay**.

Step 3 Select **Delay Time**.

Step 4 Click **Save**.

Step 5 Optional: Check Low Power Protect and select Low Power Protect Limit. If the voltage of the recorder reaches the selected percentage, the recorder will shut down automatically.

6.3 Configure Satellite Positioning

The built-in GNSS module supports GPS (Global Positioning System), enabling device positioning and speed limit alarm.

Before You Start

Install the positioning antenna.

Step 1 Go to **Configuration > Vehicle > Position Settings > Location Configuration**.

Step 2 Select **Position Module**.

The screenshot shows the 'Location Configuration' menu with the following settings:

- Position Module: Built-in
- Locating Module: GPS
- Satellite Time Sync: Enable
- Speed Units: Kilometers Per Hour, Miles Per Hour
- Speed Limit of Alarm: 100
- Overspeed Duration (sec...): 0
- Blind Replacement (day): 2
- GPS Upload Interval (Se...): 10
- Display OSD on:
 - Analog Camera: Select All, A1, A2, A3, A4
 - IP Camera: Select All, D1, D2, D3, D4, D5, D6, D7, D8

<input type="checkbox"/> Normal Linkage	<input type="checkbox"/> Trigger Alarm Output
<input checked="" type="checkbox"/> Audible Warning	<input type="checkbox"/> A->1
<input type="checkbox"/> Send Email	<input type="checkbox"/> A->2

Figure 6-1 Configure Satellite Positioning

Built-in

Obtain data from the satellite positioning module built in the recorder.

Intelligent Display Terminal

Obtain data from display terminal.

Step 3 Select **Locating Module**.

Step 4 **Optional:** Check **Enable** of **Satellite Timing** to synchronize recorder time with satellite time.

Step 5 Configure speed limit.

- 1) Select **Speed Units**.
- 2) Enter **Speed Limit of Alarm**.
- 3) Enter **Overspeed Duration (seconds)**.

If vehicle speed exceeds the set value, the recorder will alarm.

Step 6 Check the channels you want the positioning information to be displayed.

Step 7 Enter **Blind Replacement** and **GPS Upload Interval**.

Blind Replacement

In the area without network signal, after the signal restores, the positioning information from the start time without network signal to the current time will be uploaded. For example, if you enter 3, after the network signal restores, the data from 3 days ago to now will be uploaded.

GPS Upload Interval

The positioning information will be uploaded according to the set interval.

Step 8 The positioning information will be displayed in the live view and playback mode of the selected channel.

Step 9 Configure linkage actions.

- If you want the speeding vehicle to trigger the speed alarm, check **Trigger Alarm Output**.
- If you want the speeding vehicle to trigger the system to beep, check **Audible Warning**.

Step 10 Click **Save**.

6.4 Configure G-Sensor Alarm

G-Sensor detects and records acceleration information in 3-axial (X, Y, Z) directions.

Before You Start

Connect a G-sensor to the recorder.

Step 1 Go to **Configuration > Vehicle > G-Sensor**.

Module Choice	<input checked="" type="radio"/> Built-in	<input type="radio"/> External
X Acc Alarm	± <input type="text" value="1"/> . <input type="text" value="0"/>	
Y Acc Alarm	± <input type="text" value="1"/> . <input type="text" value="0"/>	
Z Acc Alarm	± <input type="text" value="1"/> . <input type="text" value="0"/>	
<input checked="" type="checkbox"/> Normal Linkage	<input type="checkbox"/> Trigger Alarm Output	
<input checked="" type="checkbox"/> Audible Warning	<input type="checkbox"/> A->1	
	<input type="checkbox"/> A->2	

Figure 6-2 Configure G-Sensor

Step 2 Select module according to actual situation.

- **External:** The G-sensor is connected to the device through RS-232/RS-485 interface.
- **Built-in:** The G-sensor is a built-in module of the device.

Step 3 Set the limit value for acceleration alarm in X, Y and Z directions.

Note

X, Y and Z represent the direction of acceleration and the unit of alarm value is G ($G=9.8 \text{ m/s}^2$). During driving, the recorder will alarm when acceleration of any direction exceeds the set value.

Step 4 Set the linkage actions for acceleration alarm, including **Audible Warning** and **Alarm Output**.

Step 5 Click **Save**.

6.5 Configure Sensor-in

Sensor-in detects and records the vehicle's driving information, including pedal braking, turning left/right, reversing, etc.

Before You Start

Connect the recorder sensor-in interface and vehicle corresponding interface. For details, refer to quick user guide.

Note

If sensor-in is disabled, you can configure it via alarm input. For example, for the recorder with 4-ch alarm inputs, according to the sequence of the parameters on the interface, braking corresponds to No. 5 alarm input (A<-5), turning left corresponds to No. 6 alarm input (A<-6), and so on. Refer to "Configure Alarm Input" for details.

Step 1 Go to **Configuration > Vehicle > Sensor-In**.

Sensor-In

Enable	<input checked="" type="checkbox"/>	
	Trigger Level	Pop Channel
Brake	High Level ▼	None ▼
Turn Left	High Level ▼	None ▼
Turn Right	High Level ▼	None ▼
Reverse	High Level ▼	None ▼

Figure 6-3 Sensor-In

Step 2 Check **Enable**.

Step 3 Select Trigger Level and Pop Channel according to actual situation.

The image of selected channel will be displayed in full screen when sensor-in is triggered.

Step 4 Click **Save**.

6.6 Configure Storage for Calamity

Step 1 Go to **Configuration > Vehicle >Storage for Calamity**.

Step 2 Check **Enable**.

Step 3 Select Redundant Channel.

The screenshot shows a configuration page titled "Storage For Calamity Config". It contains the following elements:

- Enable:** A checked checkbox.
- Status:** A text field containing "Not Exist".
- Forecast Lifetime:** A text field containing "0 Hour".
- Redundant Channel:** A row of radio buttons labeled A1, A2, A3, A4, D1, D2, D3, D4, D5, D6, D7, and D8. The A1 and A2 buttons are checked.
- Save Button:** A red button with a white floppy disk icon and the text "Save".

Figure 6-4 Storage for Calamity

Step 4 Click **Save**.

6.7 Configure Video Encryption

Step 1 Go to **Configuration > Vehicle >Video Encryption**.

Step 2 Check **Enable**.

Step 3 Set the Encryption and Decryption Key.

The screenshot shows a configuration page for video encryption. It contains the following elements:

- Encryption Key:** A text input field with a masked key (represented by seven dots) and a toggle icon on the right.
- Decryption Key:** A text input field with a masked key (represented by seven dots) and a toggle icon on the right.
- Save Button:** A red button with a white floppy disk icon and the text "Save".

Figure 6-5 Encryption and Decryption Key

Step 4 Click **Save**.

6.8 Configure Algorithm Mode

Only selected algorithm(s) will appear in the VCA and Events.

Step 1 Go to **Configuration > Vehicle > Algorithm Mode**.

Step 2 Check **Enable**.

Step 3 Select one algorithm or the combination of algorithms.

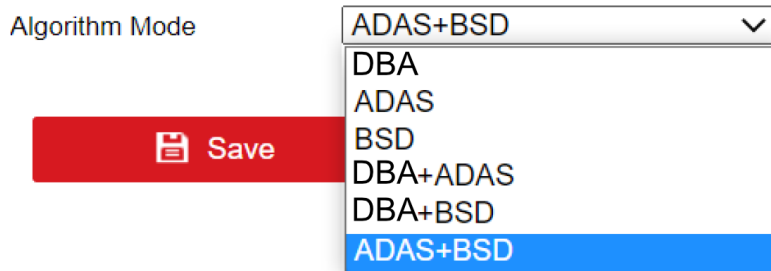

Figure 6-6 Algorithm Mode

Step 4 Click **Save**.

Chapter 7 Camera Management

7.1 Configure Encoding Parameters

Configure encoding parameters to adjust live view image and video parameters.

Go to **Configuration > Video/Audio > Video**.

In good network situation, you can set high resolution and bitrate to improve image quality.

In bad network situation, you can set low resolution, bitrate, and frame rate to get fluent image.

- In good network situation, you can set high resolution and bitrate to improve image quality.
- In bad network situation, you can set low resolution, bitrate, and frame rate to get fluent image.
- In bad network situation, if you want to guarantee the resolution, you can set low bitrate and frame rate to get fluent image.

Table 7-1 Encoding Parameters

Options	Descriptions
Stream Type	<p>Main Stream: The stream stands for the best stream performance the device supports. It usually offers the best resolution and frame rate the device can do. But high resolution and frame rate usually means larger storage space and higher bandwidth requirements in transmission.</p> <p>Sub Stream: The stream usually offers comparatively low resolution options, which consumes less bandwidth and storage space.</p>
Video Type	If you want to record both video and audio, select Video&Audio . If you just want to record video, select Video Stream .
Resolution	The higher the resolution, the clearer the image, and the higher the requirement of network bandwidth.
Bitrate Type	You can select Variable or Constant .
Video Quality	If the bitrate is variable, you can select video quality according to your needs. The higher the video quality, the higher the requirement of network bandwidth.
Frame Rate	The higher the frame rate, the higher the requirement of network bandwidth, and the higher the needed storage capacity.

Max. Bitrate	If the bitrate is variable, enter the max. bitrate. The bitrate will change automatically below the max. value.
Video Encoding	Select H.265 (only supported by some models) or H.264 according to the actual needs.



7.2 Configure Audio Parameters

You can configure the audio encoding format.

The device supports embedded audio or peripheral audio device has been connected

Step 1 Go to **Configuration > Video/Audio > Audio**.

Step 2 Select **Analog Channel Audio Coding** and **Intercom Audio Coding**.



Note

The selected encoding format should be the same with that of the embedded audio or peripheral audio device.

Step 3 Click **Save**.

7.3 Image Settings

7.3.1 Set Image Parameters

You can adjust image parameters including brightness, contrast, etc.

Step 1 Go to **Configuration > Image > Display Settings**.

Step 2 Select **Channel No**.

Step 3 Set image parameters.

Table 7-2 Image Parameters

Options	Descriptions
Scene	Select Standard, Indoor, Outdoor or DimLight according to the actual situation.
Brightness	It refers to the max. brightness of the image.
Contrast	It refers to the contrast of the image. Set it to adjust the levels and permeability of the image.

Saturation	It refers to the colorfulness of the image color.
Hue	It refers to the hue of the image.
Sharpness	It refers to the edge contrast of the image.
Denoising	If refers to reduce video noise reduction of the image.
Mirror Type	When the visual angle of the live view image deviates with that of the actual covered area, you can set the mirror type to adjust the image to the normal visual angle.

 **Note**

The supported parameters may vary with different models. The actual device prevails.

Step 4 Optional: When the image color is imbalanced, or the lens cannot be controlled, click **Default** to improve the image.

7.3.2 Set Mirror Type

You can enable mirror image and set mirror type to get suitable image.

Step 1 Go to **Configuration > Image > Display Settings**.

Step 2 Select **Mirror Type** as desired.

 **Note**

The function varies with recorder model.

7.3.3 Restore Default Parameters

You can restore image parameters to defaults.

Go to **Configuration > Image > Display Settings**, select **Channel No.**, and click **Default**.

7.4 Set OSD Parameters

Configure the camera name, OSD (On Screen Display) settings, etc.

Step 1 Go to **Configuration > Image > OSD Settings**.

Step 2 Select **Channel No.**

Step 3 Select **Display Mode** and **OSD Size**.

Step 4 Set the display content.

- Check Display Name and enter Camera Name, and enter Time Format and Date Format.
- Check Display Date, and enter Time Format and Date Format.
- Check Display Week.

Step 5 Set **OSD Display Mode**.

Step 6 Optional: To display text on OSD, check one of the **Text Overlay** and enter text.

Step 7 Drag the red frame on live view window to adjust OSD position.

Step 8 Click **Save**.

Result

The check display contents will be overlaid on the live view image and videos.

7.5 Set Privacy Mask

The privacy mask can be used to protect personal privacy by concealing parts of the image from view or recording with a masked area.

Step 1 Go to **Configuration > Image > Privacy Mask**.

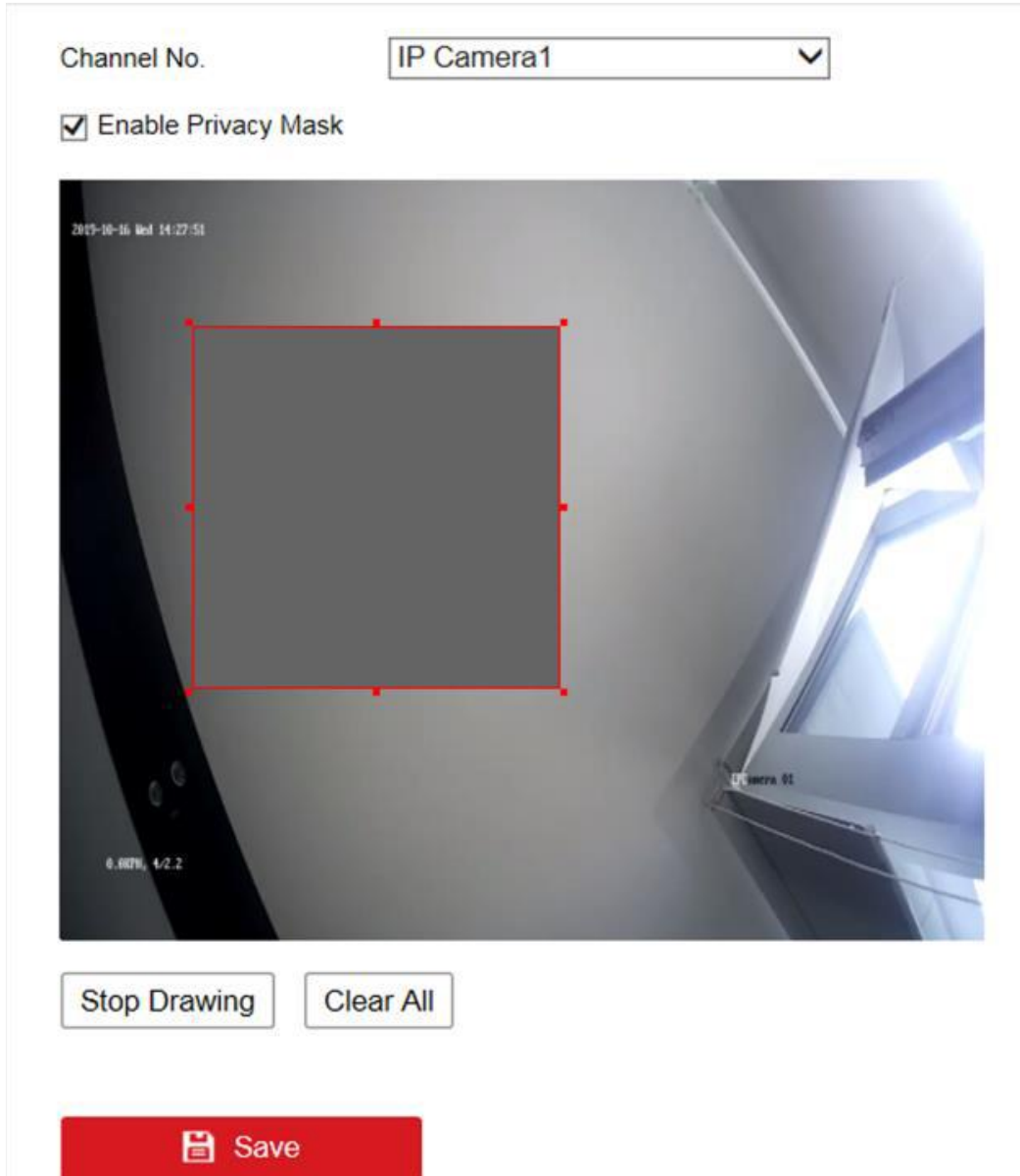

Figure 7-1 Configure Privacy Mask

Step 2 Select **Channel No.**

Step 3 Check **Enable Privacy Mask.**

Step 4 Draw detection area.

- 1) Click Draw Area.
- 2) In preview area, drag to draw the detection area.
- 3) Click Stop Drawing.

 **Note**

Up to four privacy mask areas are supported for each channel.

Step 5 Optional: Click **Clear All** to clear all the drawn areas.

Step 6 Click **Save**.

Result

The image of drawn area will be shield in the live view and videos.

Chapter 8 Storage Settings

Before you start:

To configure record settings, make sure that you have the network storage device or local storage device configured.

8.1 Record Schedule

Purpose:

There are two kinds of recording for the cameras: manual recording and scheduled recording. In this section, you can follow the instructions to configure the scheduled recording. By default, the record files of scheduled recording are stored in the local storage or in the network disk.

Step 1 Go to **Configuration > Storage > Schedule Settings > Record Schedule.**

Record Schedule

Channel No. ▼
 Record Status ▼

Enable Record Plan

▼ ✕ Delete 🗑️ Delete All Advanced

Mon	0	2	4	6	8	10	12	14	16	18	20	22	24
Tue	0	2	4	6	8	10	12	14	16	18	20	22	24
Wed	0	2	4	6	8	10	12	14	16	18	20	22	24
Thu	0	2	4	6	8	10	12	14	16	18	20	22	24
Fri	0	2	4	6	8	10	12	14	16	18	20	22	24
Sat	0	2	4	6	8	10	12	14	16	18	20	22	24
Sun	0	2	4	6	8	10	12	14	16	18	20	22	24

- Continuous
- Alarm
- Motion
- Motion | Alarm
- Motion & Alarm

Figure 8-1 Recording Schedule Interface

Step 2 Check the checkbox of **Enable** to enable scheduled recording.

Step 3 Click **Advanced** to set the camera record parameters.

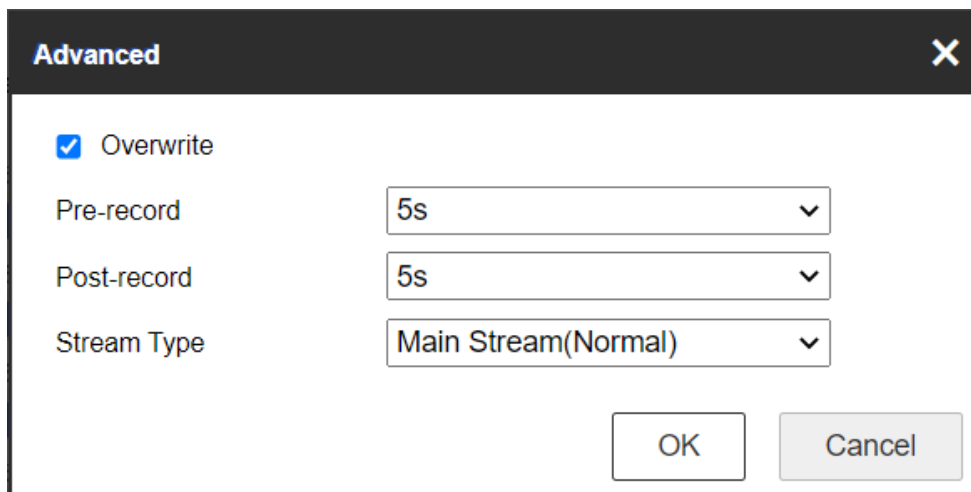

Figure 8-2 Record Parameters

- **Pre-record:** The time you set to start recording before the scheduled time or the event. For example, if an alarm triggers recording at 10:00, and the pre-record time is set as 5 seconds, the camera starts to record at 9:59:55.

The Pre-record time can be configured as No Pre-record, 5s, 10s, 15s, 20s, 25s, 30s or not limited.

- **Post-record:** The time you set to stop recording after the scheduled time or the event. For example, if an alarm triggered recording ends at 11:00, and the post-record time is set as 5 seconds, the camera records until 11:00:05.

The Post-record time can be configured as 5s, 10s, 30s, 1 min, 2 min, 5 min or 10 min.

- **Stream Type:** Select the stream type for recording.

Note

The record parameter configurations vary depending on the camera model.

Step 4 Select a **Record Type**. The record type can be either Continuous or Event.

- **Continuous**

If you select **Continuous**, the video will be recorded automatically according to the time of the schedule.

- **Record Triggered by Events**

If you select **Event**, the video will be recorded if any of the events is triggered. Besides configuring the recording schedule, you have to configure the event settings.

Step 5 Select the record type, and click-and-drag the mouse on the time bar to set the record schedule.

Step 6 Click **Save** to save the settings.

8.2 Storage Management

You can manage the storage by configuring the support for recording backup on redundant HDD/SSDs, formatting the storage, and checking the condition of storage media.

8.2.1 HDD Management

Step 1 Go to **Configuration > Storage > Storage Management > HDD Management**, in which you can view the capacity, free space, status, type and property of the disk.

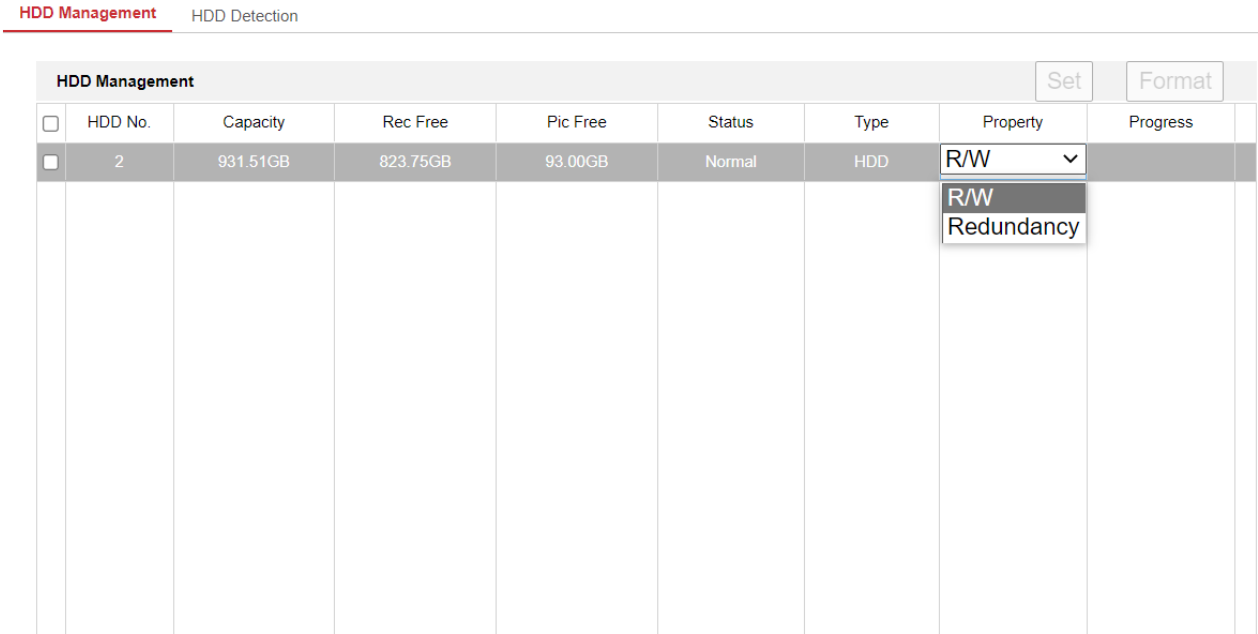

Figure 8-3 Storage Management Interface

Step 2 If the status of the disk is **Uninitialized**, check the corresponding checkbox to select the disk and click **Format** to start initializing the disk.

Step 3 When the initialization completed, the status of disk will become **Normal**.

Step 4 To configure the recording backup on the redundant HDD/SSD, you need to set its property. Choose R/W for main storage and Redundancy for redundant storage.

8.2.2 HDD Detection

Go to HDD Detection to configure S.M.A.R.T. Detection and Bad Sector Detection.

HDD Management **HDD Detection**

S.M.A.R.T. Detection > Bad Sector Detection

Continue to use this disk when self-evaluation is failed.

HDD No.

Self-test Status Interrupted

Self-test Type

S.M.A.R.T.

Temperature 42°C

Power On 0Day(s)

Self-evaluation Pass

All-evaluation Functional

Figure 8-4 Configure S.M.A.R.T.

The S.M.A.R.T. information can be found below.

S.M.A.R.T. Information							
ID	Attribute Name	Flags	Thresh...	Value	Worst	Raw Value	Status
1	Raw Read Error Rate	15	6	74	67	27914804	ok
3	Spin Up Time	3	0	99	99	0	ok
4	Start/Stop Count	50	20	100	100	26	ok
5	Reallocated Sector Count	51	10	100	100	0	ok
7	Seek Error Rate	15	45	100	253	180295	ok
9	Power-on Hours Count	50	0	100	100	5	ok
10	Spin Up Retry Count	19	97	100	100	0	ok
12	Power Cycle Count	50	20	100	100	26	ok
184	Reported IOEDC errors	50	99	100	100	0	ok
187	Reported Uncorrectables	50	0	100	100	0	ok
188	Command Timeout Count	50	0	100	100	0	ok
189	High Fly Writes	58	0	100	100	0	ok
190	Airflow Temperature	34	40	58	18	73721774122	ok

Figure 8-5 S.M.A.R.T. information

To check the condition of the HDD, you can run a test for bad sector at Bad Sector Detection.

Other

Enable Overwriting

Enable Print Log

Image Partition(%)

 **Save**

Figure 8-7 Advanced Settings

Chapter 9 Smart Functions

9.1 Driving Behavior Configuration

The function analyzes driver's behavior, including distraction, fatigue driving, phone call, smoking, seatbelt unbuckled etc. The recorder will trigger warning when these behaviors are detected.

9.1.1 Configuration

Calibrate Camera Position

Calibrate network camera position before enabling driving behavior detection.

Before You Start

Add the network camera in your recorder.

Step 1 Go to **Configuration > VCA > Driving Behaviors > Camera Position Calibration**.

Step 2 Select **Channel No.**

Step 3 Adjust the network camera position to make the driver face image appear in the red frame and his chin is above the yellow line.

Configure Driving Behavior Analysis

Set the driving behavior analysis parameters according to actual situation to lower false detection rate.

Step 1 Go to **Configuration > VCA > Driving Behaviors > Driving Behaviors**.

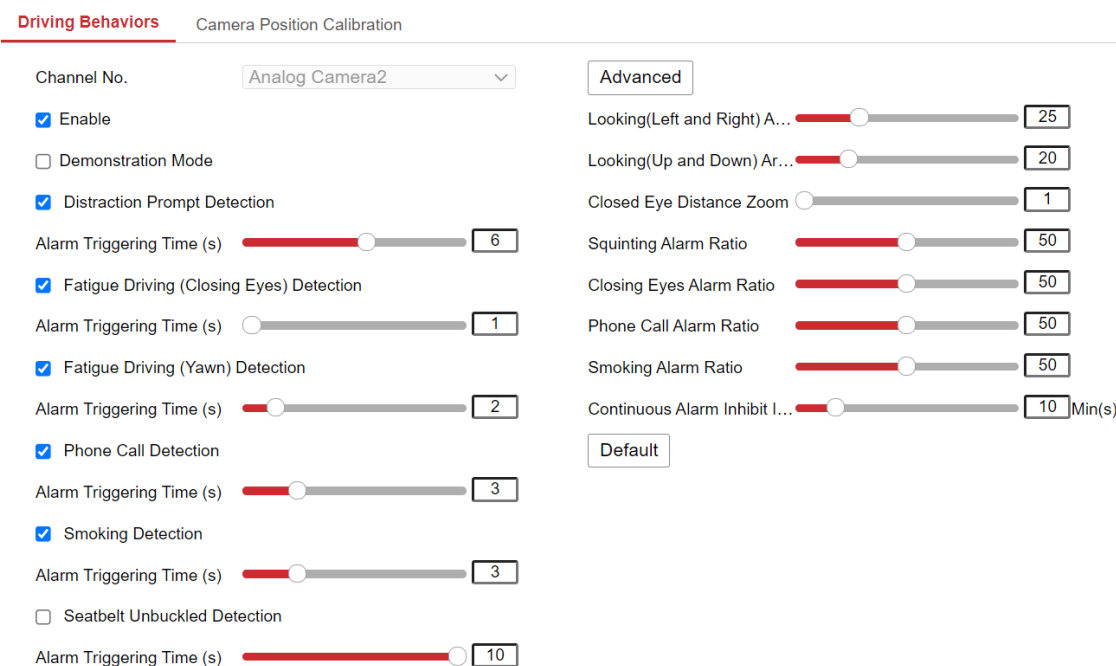

Figure 9-1 Driving Behaviors

Step 2 Select **Camera No.**

Step 3 Check **Enable.**

Step 4 Check behaviors to analyze and configure their parameters.

- Alarm Time

Device alarms when the corresponding driving behavior lasts for the set time.

- Constant Alarm Filter Interval

Available for on-the-phone detection and smoking detection. The higher the value is, the lower the false detection rate. You are recommended to use the default value.

- Stop Detections when Driving in Low-Speed

The feature is valid when GPS positioning succeeded. When the vehicle speed is lower than the set value, all the driving behavior analyses will stop.

- Voice Alarm

When it is checked, device will send out voice alarm when a checked behavior is detected.

- Enable Capture Image

When it is checked, device will make a capture when a checked behavior is detected.



One recorder supports analyze driving behavior for one channel at a time. Enabling the driving behavior analysis will disable driving behavior analysis of other channels.

Step 5 Click **Save.**

Result

When a concerned driving behavior is detected, the connected intercom will automatically send out audio broadcast.

9.1.2 Play Videos and Pictures

We take the example of playing videos to describe the steps.

Step 1 Go to **Playback.**

Step 2 Select a channel in channel list.

Step 3 Click Event **Search.**

Step 4 Select **Event Type** as **Driver Behavior.**

Step 5 Set search conditions.

Step 6 Click **Search.**

Step 7 Select videos to play.

9.2 ADAS Setting

9.2.1 Calibrate ADAS

The ADAS camera needs calibration to function normally. To configure calibration configuration, type in the parameters of the camera installation and the vanishing point line.

Step 1 Go to **Configuration > VCA > ADAS > ADAS Event**.

ADAS Event **Install ADAS**

Channel No.

Enable

Camera Param

Installation Height(m)

Distance to the Front Bu...

Distance to the Left Whe...

Distance to the Right Wh...

Vanishing Point Line

Proportion of vehicle head

Vanishing Point - X Coor...

Vanishing Point - Y Coor...

Figure 9-2 ADAS Calibration

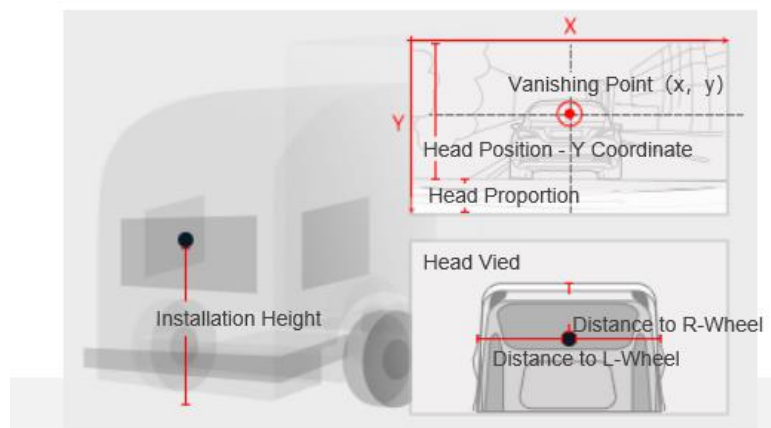

Figure 9-3 Parameters

Step 2 Fill in the following installation parameters accurate to 2 digits:

- Installation Height (m): distance between the camera and the ground.
- Distance to the Front Bumper (m): distance between the camera and the bumper.

- Distance to the Left Wheel (m): distance between the camera and the left wheel.
- Distance to the Right Wheel (m): distance between the camera and the right wheel.

Step 3 Calibrate the Vanishing Point Line. Type in the value of Proportion of vehicle head. The default value is 0.940.

Step 4 Drag the center of the red line to the line where the ground meets the sky and locate the point the road. The Vanishing Point - X Coordinate and Vanishing Point - Y Coordinate will be automatically filled.



Step 5 Click **Save** to save the configuration.

9.2.2 ADAS Event

To configure ADAS Events for the device, go the VCA section of the setting where you can set up parameters for ADAS alarms and calibrate the ADAS camera installation.

Step 1 Go to **Configuration > VCA > ADAS > ADAS Event**.

Step 2 Choose which channel to configure and then enable the ADAS Event function.

Step 3 Set the Constant Alarm Filter Interval, range 1 to 60 minutes, default at 10. If a type of event has been detected, then within a given range of minutes, the same type of event will be filtered.

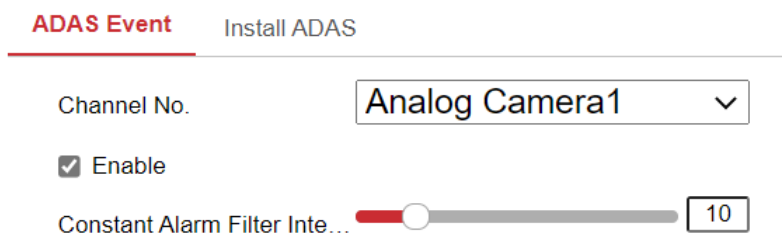

Figure 9-4 Enable ADAS

Step 4 Choose the Event Type.

- Forward Collision Warning

Alarm if the vehicle's time to collide with the front vehicle is lower than a threshold. The threshold is calculated by relative speed and the distance between vehicles.

- Lane Departure Warning

Alarm if the vehicle is leaving the lane.

- Pedestrian Collision Warning

Alarm if the vehicle is going to collide with the pedestrian.

- Traffic Sign Recognition

Alarm if the vehicle's speed is higher than the speed limit of the traffic sign captured by the device.

- Headway Monitoring Warning

Alarm if the vehicle's time to collide with the front vehicle is lower than a threshold. The threshold is calculated by the absolute speed and the distance between vehicles.

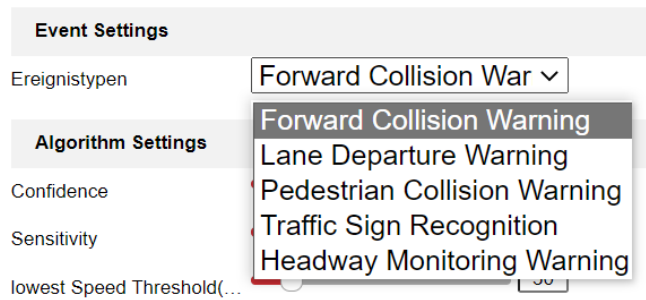

Figure 9-5 Event Type

Step 5 Configure Algorithm Settings and Alarm Settings for the chosen event type.

- Confidence: range from 0 to 100, default at 50. Confidence means the credibility of the alarm. The higher the confidence, the more reliable the alarm.
- Sensitivity: range from 1 to 3, default at 2. Sensitivity means the time interval between the detection of event and the alarm signal.
- Lowest Speed Threshold: the device will only trigger alarm when the vehicle speed is between the value of the set speed and the Max speed.
- Highest Speed Threshold: the device will only trigger alarm when the vehicle speed is between the value of the Lowest Speed Threshold and the set speed.

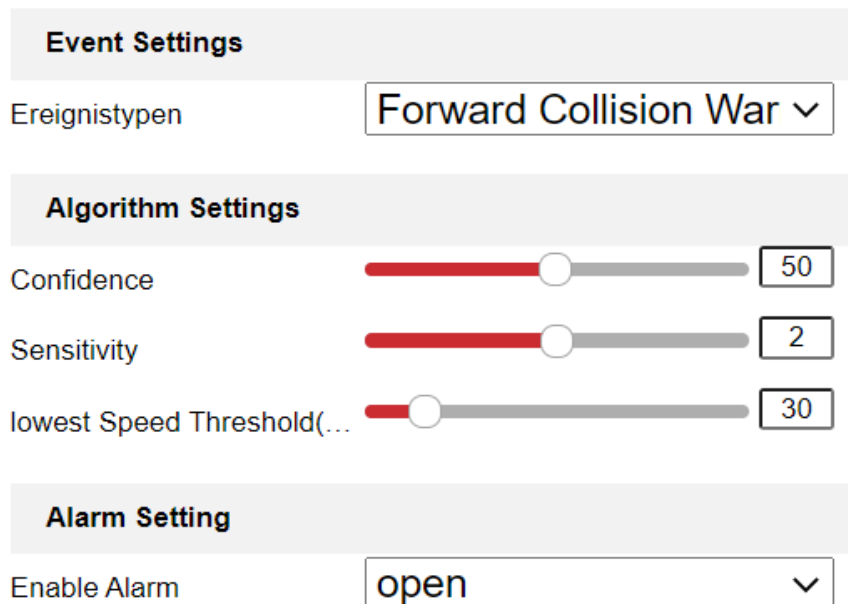

Figure 9-6 Forward Collision Warning

Event Settings

Ereignistypen

Algorithm Settings

Confidence

Sensitivity

lowest Speed Threshold(...)

Alarm Setting

alarm Event Enable (Left)

alarm Event Enable (Rig...)

Figure 9-7 Lane Departure Warning

Event Settings

Ereignistypen

Algorithm Settings

Confidence

Sensitivity

highest Speed Threshold(...)

remark : PCW function could be available when vehicle speed is below the highest threshold

Alarm Setting

Enable Alarm

Figure 9-8 Pedestrian Collision Warning

Event Settings

Ereignistypen

Algorithm Settings

Confidence 50

Sensitivity 2

lowest Speed Threshold(...) 30

Alarm Setting

Enable Alarm

Figure 9-9 Traffic Sign Recognition

Event Settings

Ereignistypen

Algorithm Settings

Confidence 50

Safety Time Threshold

lowest Speed Threshold(...) 30

Alarm Setting

Enable Alarm

Figure 9-10 Headway Monitoring Warning

Step 6 Choose whether to enable the alarm.

Step 7 Click **Save** to save the configuration.

9.3 BSD Setting

9.3.1 Calibrate BSD Area

The BSD camera needs calibration to function normally. To configure calibration configuration, type in the parameters of the camera installation.

Step 1 Go to **Configuration > VCA > Blind Spot Detection > Area Settings.**

Blind Spot Detection **Area Settings**

Channel No.
 Set Area

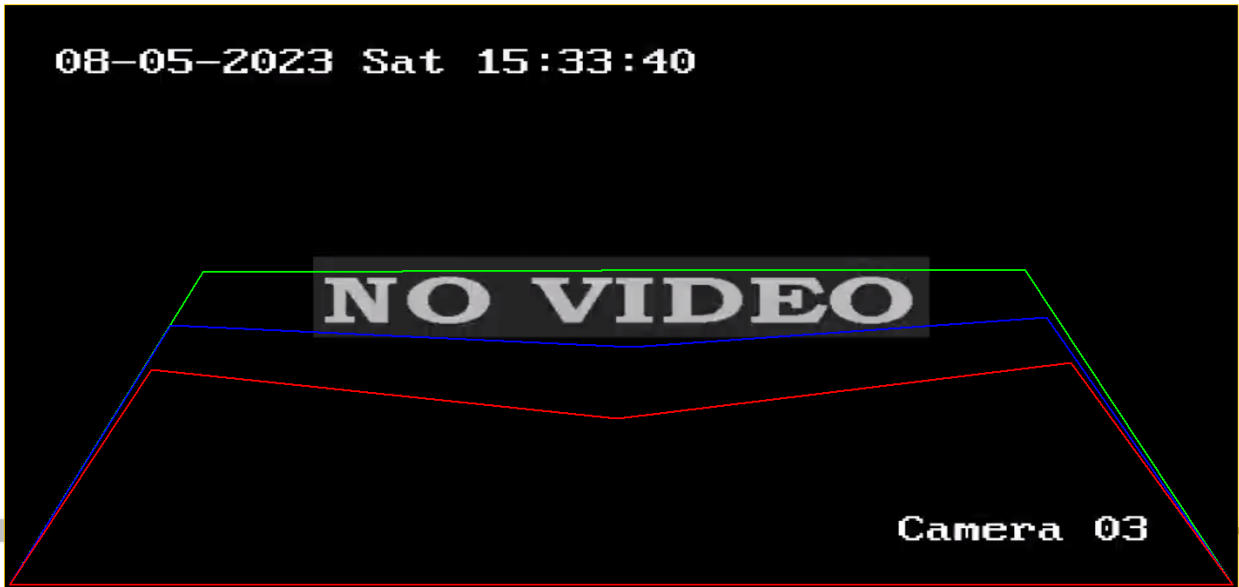

Figure 9-11 Area Settings

Step 2 Choose and set the level area, drag and set the area.

Note

When moving the position point, do not change the relative position of the different levels.

Step 3 Optional: choose the default settings.

Step 4 Click **Save**.

9.3.2 Blind Spot Detection

Step 1 Go to **Configuration > VCA > Blind Spot Detection > Blind Spot Detection.**

Blind Spot Detection Area Settings

Channel No. Analog Camera3 ▼

Enable

Enable Associated Turn Signal Lamps

Enable Algorithm Detection(person)

Enable Algorithm Detection(non motor vehicles)

Enable Algorithm Detection(motor vehicles)

Vehicle Speed Alarm Thr... 30

Suppression Time (s) 1

Installation Position Right front 1 meter ▼

Sensitivity 2

Enable Capture Image

 Save

Figure 9-12 Blind Spot Detection

Step 2 Check Enable.

- Enable Associated Turn Signal Lamps: BSD will only function when the right turn signal is on.
- Vehicle Speed Alarm Threshold: BSD will only function when the speed is lower than the value.
- Sensitivity: the higher, the easier to trigger alarm.

Step 3 Click **Save**.

Chapter 10 Events and Alarms

10.1 Configure Motion Detection Alarm

When motion detection alarm is configured, once a motion event is detected, the device starts to record and multiple linkage actions will be triggered.

Step 1 Go to **Configuration > Event > Basic Event > Motion Detection**.

Step 2 Select **Channel No.**

Step 3 Draw detection area.

- 1) Click **Draw Area**.
- 2) In preview area, drag to draw the detection area.
- 3) Click **Stop Drawing**.

Step 4 Set **Sensitivity**.

Step 5 Configure arming schedule. For detailed steps, refer to *Configure Arming Schedule*.

Step 6 Configure linkage method. For detailed steps, refer to *Configure Linkage Actions*.

Step 7 Click **Save**.

10.2 Configure Video Tampering Alarm

A tampering alarm is triggered when the camera is covered and the monitoring area cannot be viewed. Linkage actions, including audible warning, alarm output, can be set to respond.

Step 1 Go to **Configuration > Event > Basic Event > Video Tampering**.

Step 2 Select **Channel No.**

Step 3 Draw detection area.

- 1) Click Draw Area.
- 2) In preview area, drag to draw the detection area.
- 3) Click Stop Drawing.

Step 4 Configure arming schedule. For detailed steps, refer to *Configure Arming Schedule*.

Step 5 Configure linkage method. For detailed steps, refer to *Configure Linkage Actions*.

Step 6 Set **Sensitivity**.

Step 7 Click **Save**.

10.3 Configure Video Loss Alarm

When the recorder cannot receive video signal from the analog cameras, the video loss alarm will be triggered. Linkage actions, including audible warning and alarm output, can be set to respond.

Step 1 Go to **Configuration > Event > Basic Event > Video Loss**.

Step 2 Check **Enable Video Loss Detection**.

Step 3 Configure arming schedule. For detailed steps, refer to *Configure Arming Schedule*.

Step 4 Configure linkage method. For detailed steps, refer to *Configure Linkage Actions*.

Step 5 Click **Save**.

10.4 Configure Alarm Input

Configure the settings for alarm input, including trigger level, arming schedule and alarm linkage actions, etc.

Before You Start

Connect an alarm device to your recorder.

Step 1 Go to **Configuration > Event > Basic Event > Alarm Input**.

Alarm Input No. IP Address

Trigger Level Alarm Name (Cannot Copy) ✓

Alarm Type Alarm Status (Cannot Copy)

Enable Alarm Input Handling

Arming Schedule Linkage Method

Day	0	2	4	6	8	10	12	14	16	18	20	22	24
Mon	[Active]												
Tue	[Active]												
Wed	[Active]												
Thu	[Active]												
Fri	[Active]												
Sat	[Active]												
Sun	[Active]												

Figure 10-1 Configure Alarm Input

Step 2 Select Alarm Input No. and enter Alarm Name.

Step 3 Select Alarm Type according to alarm device type.

Step 4 Check **Enable Alarm Input Handling**.

Step 5 Configure arming schedule. For detailed steps, refer to *Configure Arming Schedule*.

Step 6 Configure linkage method. For detailed steps, refer to *Configure Linkage Actions*.

Step 7 Optional: Click **Copy to** and select desired channels to copy the above settings to other alarm inputs.

Step 8 Click **Save**.

10.5 Configure Alarm Output

Configure the arming schedule, alarm duration time and alarm name for alarm output.

Before You Start

Connect alarm output device to your recorder. For details, refer to installation guide.

Step 1 Go to **Configuration > Event > Basic Event > Alarm Output**.

Alarm Output No. IP Address

Default Status Triggering Status

Delay Alarm Name (Cannot Copy) ✓

Alarm Status (Cannot Copy)

Arming Schedule

✗ Delete 🗑️ Delete All

	0	2	4	6	8	10	12	14	16	18	20	22	24
Mon	[Blue bar]												
Tue	[Blue bar]												
Wed	[Blue bar]												
Thu	[Blue bar]												
Fri	[Blue bar]												
Sat	[Blue bar]												
Sun	[Blue bar]												

Figure 10-2 Configure Alarm Output

Step 2 Select **Alarm Output No.** and enter **Alarm Name**.

Step 3 Select **Delay** to set dwell time.

Alarm output will continue for the set time.

Step 4 Configure arming schedule. For detailed steps, refer to *Configure Arming Schedule*.

Step 5 **Optional:** Click **Manual Alarm** to trigger alarm manually. Click **Stop Alarm** to stop manual alarm.

Step 6 **Optional:** Click **Copy to** and select desired channels to copy the above settings to other alarm outputs.

Step 7 Click **Save**.

10.6 Configure Exception Alarm

Configure alarms which are triggered by exceptions to take necessary actions in time.

Step 1 Go to **Configuration > Event > Basic Event > Exception**.

Step 2 Select Exception Type.

Step 3 Configure linkage method. For detailed steps, refer to *Configure Linkage Actions*.

Step 4 Click **Save**.

10.7 Configure Driving Behaviors Alarm



To enable intelligent alarm, go to **Configuration > Vehicle > Algorithm Mode**.

Step 1 Go to **Configuration > Event > Basic Event > Driving Behaviors**.

Step 2 Check **Enable**.

Step 3 Choose the specific alarm for each channel.

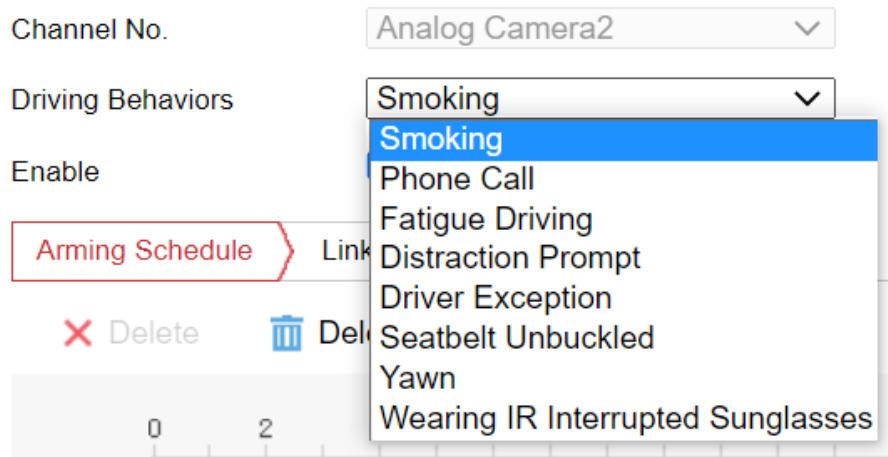

Figure 10-3 Choose Alarm

Step 4 Configure linkage method. For detailed steps, refer to *Configure Linkage Actions*.

Step 5 Click **Save**.

10.8 Configure ADAS Alarm

Note

To enable intelligent alarm, go to **Configuration > Vehicle > Algorithm Mode**.

Step 1 Go to **Configuration > Event > Basic Event > ADAS**.

Step 2 Check **Enable**.

Step 3 Choose the specific alarm for each channel.

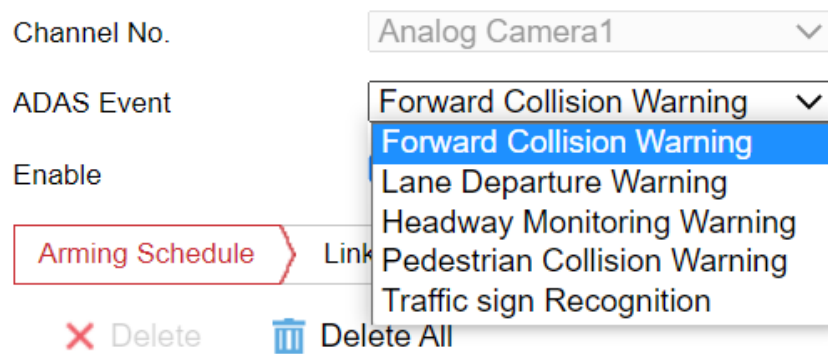

Figure 10-4

Step 4 Configure linkage method. For detailed steps, refer to *Configure Linkage Actions*.

Step 5 Click **Save**.

10.9 Configure Blind Spot Detection Alarm

Note

To enable intelligent alarm, go to **Configuration > Vehicle > Algorithm Mode**.

Step 1 Go to **Configuration > Event > Basic Event > Blind Spot Detection**.

Step 2 Check **Enable**.

Step 3 Choose the specific alarm for each channel.

Channel No.	Analog Camera3	▼
Blind Spot Detection	Right blind area	▼
Enable	<input checked="" type="checkbox"/>	

Figure 10-5 Choose Alarm

Step 4 Configure linkage method. For detailed steps, refer to *Configure Linkage Actions*.

Step 5 Click **Save**.

10.10 Configure Arming Schedule

Step 1 Drag in time line to draw an arming period.

Step 2 Adjust the set arming period.

- 1) Click a period and adjust its length.
- 2) Click a period, enter start time and end time, and click **Save**.
- 3) Click **Delete All** to delete all periods.

Note

Up to 8 time periods can be set for each day and each of the time periods cannot be overlapped.

Step 3 **Optional:** Click **Copy to** and select desired days to copy the above settings to other days.

Step 4 Click **Save**.

10.11 Configure Linkage Actions

Check the linkage action(s) when events occur, and click **Save**.

 **Note**

Linkage actions vary with event type.

Table 10-1 Linkage Actions

Options	Descriptions
Audible Warning	The device will trigger an audible beep when events occur.
Send Email	The device will send an Email alarm host when events occur.
Notify Monitoring Center	<p>The device will send an exception or alarm signal to the remote alarm host when events occur.</p> <p>The alarm host refers to the computer installed with the remote client.</p>
Full Screen Monitoring	The image of the alarm channel will pop up on the connected external monitor when events occur, and be displayed in full screen.
Trigger Alarm Output	Check the alarm output channel(s) to trigger the alarm of the connected alarm output device(s).

Chapter 11 User Management

11.1 Manage User Account

You can add and delete users, and modify the password and permission of users.

Step 1 Go to **Configuration > System > User Management**.

Step 2 Click **Add**.

Step 3 Edit new user parameters and click **OK** to create the user.

Note

We highly recommend you to create a strong password of your own choosing (using a minimum of 8 characters, including at least three kinds of following categories: upper case letters, lower case letters, numbers, and special characters) in order to increase the security of your product. And we recommend you reset your password regularly, especially in the high security system, resetting the password monthly or weekly can better protect your product.

- **Delete**
Select a user and click **Delete** to delete the user.
- **Modify**
Select a user and click **Modify** to modify the user information.

11.2 Configure Security Question

If you forgot the admin password, you can reset password by answering security questions. Follow the steps to set security questions.

Before You Start

Your computer and recorder must be in the same network segment.

Step 1 Go to **Configuration > System > User Management**.

Step 2 Click **Security Question**.

Step 3 Enter **Admin Password**.

Step 4 Set security questions.

Step 5 Click **OK**.

Result

If you forgot admin password, you can visit the recorder via computer in the same network segment with your recorder and click **Forgot Password** to reset password.

Chapter 12 Security

12.1 Configure Allowlist

Only the trusted IP addresses on the allowlist can access the device via the network.

Step 1 Go to **Configuration > System > Security > Allowlist**.

Step 2 Check **Enable Allowlist**.

Step 3 Click **Add** and enter desired IP Address, and click **OK**.

Step 4 Optional: Edit or delete the IP address.

- 1) Select an IP address and click **Modify** to edit the IP address.
- 2) Select an IP address and click **Delete** to delete the IP address.

Step 5 Click **Save**.

12.2 Configure SSH

SSH is disabled by default for security reasons. This setting is reserved for professional maintenance personnel only.

Step 1 Go to **Configuration > System > Security > Security Service**.

Step 2 Uncheck **Enable SSH**.

Step 3 Click **Save**.

Chapter 13 Maintenance

13.1 View System Information

You can view your recorder system information and edit recorder name and record number.

Go to **Configuration > System > System Settings > Basic Information** to view the recorder information. You can edit **Device Name** and **Device No.**

13.2 Search Log File

You can view and export logs saved in the recorder storage media.

Go to **Configuration > System > Maintenance > Log** to search or export logs.

13.3 Upgrade the System

You are recommended to upgrade the recorder with the help of professional technical support.

Before You Start

Save the upgrade file in computer.

Step 1 Go to **Configuration > System > Maintenance > Upgrade & Maintenance**.

Step 2 Click **Browse** and select upgrade file.

Step 3 Click **Upgrade** and click **OK** in popup message box to start upgrading.

The upgrading process will be 1 to 10 minutes, please don't disconnect power to the recorder during the process. The recorder reboots automatically after upgrading.

13.4 Configure Image Partition

Configure image partition value if you want to change the reserved image storage capacity.

Before You Start

The storage media has been formatted.

Step 1 Go to **Configuration > Storage > Advanced Settings**.

Step 2 Enter **Image Partition**.

Step 3 Click **Save**.

13.5 Configure Overwritten Recording

You can enable overwritten recording if you want to overwrite the former record files when the storage media is full. Or disable overwritten record if you want to stop recording when the storage media is full.

Step 1 Go to **Configuration > Storage > Advanced Settings**.

Step 2 Check or uncheck Enable Overwriting according to your needs.

Step 3 Click **Save**.

13.6 Print Log

If you need to debug the device, you can enable printing log.

Step 1 Go to **Configuration > Storage > Advanced Settings**.

Step 2 Check Enable Print Log.

Step 3 Click **Save**.

13.7 Rebooting

Reboot your recorder via menu instead of disconnecting power from the recorder.

Go to **Configuration > System > Maintenance > Upgrade & Maintenance**. Click **Reboot** and click **OK** in popup message box to start rebooting.

13.8 Restore Default Settings

If your recorder is abnormal, you can restore recorder to defaults settings.

Go to **Configuration > System > Maintenance > Upgrade & Maintenance**.

Restore

Restore all parameters, except the network (including IP address, subnet mask, gateway, MTU, NIC working mode, default route, server port, etc.) and user account parameters, to the factory default settings.

Default

Restore all parameters to the factory default settings.

13.9 Export Configuration File

The configuration files of the recorder can be exported to your computer for backup.

Step 1 Go to **Configuration > System > Maintenance > Upgrade & Maintenance**.

Step 2 Click Device Parameters and select the configuration file saving path.

13.10 Import Configuration File

The configuration file of one device can be imported to multiple devices if they are to be configured with the same parameters.

Only devices of the same model can share configuration file.

Step 1 Go to **Configuration > System > Maintenance > Upgrade & Maintenance**.

Step 2 Click Browse of Import Config. File and select configuration file.

Step 3 Click Import and click **OK** in popup message box to start importing.

13.11 Configure DST Settings

Configure DST (Daylight Saving Time) settings for the system.

Step 1 Go to **Configuration > System > System Settings > Time Settings**.

Step 2 Check **Enable DST**.

Step 3 Set **Start Time** and **End Time** for DST.

Step 4 Select **DST Bias**.

Step 5 Click **Save**.

13.12 Synchronize Time

Synchronize the device time when it is inconsistent with the actual time.

Step 1 Go to **Configuration > System > System Settings > Time Settings**.

Step 2 Select Time Zone according to the device location.

Step 3 Select the time synchronization mode.

– If an NTP server is available, select **NTP** and enter NTP server information to synchronize the device time with that of the NTP server.

– Select **Manual Time Sync.** and set time to customize the device time.

– Select **Manual Time Sync.** and check **Sync. with computer time** to synchronize the device time with that of the computer.

Step 4 Click **Save**.

13.13 Configure Menu Output

You can configure local output and resolution remotely.

Go to **Configuration > System > System Settings > Menu Output** to configure **Menu Output** and

Resolution.



The function varies with model.

13.14 Configure RS-232

To debug recorder via serial port or connect serial device, you can configure RS-232 parameters.

Before You Start

Connect a serial device to your recorder RS-232 interface.

Step 1 Go to **Configuration > System > System Settings > Serial Config.**

Step 2 Select COM port the serial device connects to.

Step 3 Edit Bit rate, Data Bit, Stop Bit, Parity, and Flow Control.

Step 4 Select **Usage.**

Console

Connect a computer to the recorder through the computer serial port. Recorder parameters can be configured by using software such as HyperTerminal. The serial port parameters must be the same as of the recorder when connecting with the computer serial port.

Transparent Channel

Connect a serial device directly to the recorder. The serial device will be controlled remotely by the computer through the network and the protocol of the serial device. If alarm button is connected, select RS-232 usage as Transparent Channel.

Step 5 Click **Save.**

Chapter 14 Local Menu Operation

Connect a display and a mouse to recorder, and you can operate the recorder locally.

14.1 Manage IP Camera

The section is only available for the recorder that supports network camera.

14.1.1 Activate IP Camera

Before adding an IP camera, activate it by setting a password for it.

Before You Start

Connect the IP camera to IP camera interface in the recorder rear panel.

Step 1 Go to **Menu > Other Settings > IPC Settings**.

Step 2 Click **Manual Management**.

Step 3 Select an inactivated IP camera.

Step 4 Activate the selected IP camera.

- Click **Quick Active**. The IP camera password will be set as the same with the device password.
- Click **Manu Active** and enter the same password in **New Password** and **Confirm**.

 **Note**

We highly recommend you to create a strong password of your own choosing (using a minimum of 8 characters, including at least three kinds of following categories: upper case letters, lower case letters, numbers, and special characters) in order to increase the security of your product. And we recommend you reset your password regularly, especially in the high security system, resetting the password monthly or weekly can better protect your product.

14.1.2 Add IP Camera

Before You Start

The IP camera is active.

Step 1 Go to **Menu > Other Settings > IPC Settings**

Step 2 Uncheck Auto Add and click Manage IP Camera.

Step 3 Edit camera IP address.

- 1) Select an IP camera and click **Edit**.
- 2) Enter an IP address that is in the same network segment with the recorder.

Step 4 Add the IP camera.

Step 5 Click Manual Add.

Step 6 Select IP channel No. for the IP camera.

Step 7 Edit the required information.

Step 8 Click **OK**.

14.1.3 Edit IP Camera

You can edit or delete added IP cameras.

Step 1 Go to **Menu > Other Settings > IPC Settings**.

Step 2 Optional: You can change the parameters of the added IP cameras.

- 1) Select an IP camera.
- 2) Edit the parameters. If you change the IP address, you will connect to another IP camera.
- 3) Click **OK**.

Step 3 **Optional**: Select an IP camera, click **Delete** to delete the IP camera.

14.2 Recording

To record the videos for connected cameras, you need to install a storage media and format it, and configure the recording schedule.

14.2.1 Format Storage Media

A newly installed storage media must be formatted before it can be used.

Before You Start

Install storage media.

Step 1 Go to **Menu > Storage**.

Step 2 Check storage media to format.

Step 3 Click Format.

After format, the storage media **Status** should be **Normal**.

14.2.2 Configure Recording Schedule

All-day recording is on by default. Device will start and stop recording according to the configured recording schedule.

Before You Start

Install storage media and format it.

Step 1 Go to **Menu > Basic Settings > Record**.

Step 2 Select the camera to set recording schedule.

Step 3 Click Set of Schedule.

Step 4 Check **Enable Schedule**.

Step 5 Select the day from the dropdown list for settings.

Step 6 Configure all day schedule or custom schedule.

- Check **All Day** to enable all-day recording, and then select the recording type from the dropdown list.
- Uncheck **All Day**, customize the time period for recording, and select the recording type for each time period.



Up to 8 time periods can be set for each day and each of the time periods cannot be overlapped.

Step 7 Click **OK**.

14.3 Playback

You can search and play back the videos stored on the recorder.

Step 1 Go to **Menu > Video Search**.

Step 2 Select **Search Mode**.

General

Normal videos.

Event

Motion detection, alarm, motion|alarm, motion&alarm videos.

Step 3 Select **Camera, Video Type, Start Time, and End Time**.

Step 4 Click **Search**.

Step 5 Select a video and click Play.

14.4 Back up

Back up the videos stored on the recorder.

Before You Start

Connect a USB storage device to your recorder.

Step 1 Go to **Menu > Video Search**.

Step 2 Select **Search Mode**.

General

Normal videos.

Event

Motion detection, alarm, motion|alarm, motion&alarm videos.

Step 3 Select **Camera, Video Type Start Time, and End Time.**

Step 4 Click **Search.**

Step 5 Select the videos and click Export.



The number of USB interface varies with recorder model. If your recorder contains only one USB interface, you can back up videos via remote control or touchscreen.

14.5 Preview Settings

Purpose:

Configure the dwell time of live view, set the camera order, enable/disable the audio preview, etc.

Step 1 Go to **Menu > Other Settings > Preview.**

Step 2 Select the Video Output according to the actual needs.

Step 3 Configure the **Preview Mode, Dwell Time, and Enable Audio Output.**

- **Preview Mode:** Select the window division mode for live view.
- **Dwell Time:** The switch interval of the live view screen. The screen will be switched to the next one after the selected dwell time.
- **Enable Audio Output:** Enable/disable audio output for the selected video output.

Step 4 Click **OK.**

Chapter 15 Configure Smart Functions on ADAS APP

15.1 Install the ADAS APP

Scan the following QR code to download the ADAS APP.



Figure 15-1 QR Code

15.2 Configure Wi-Fi AP

Connect the Wi-Fi antenna to the device to use the ADAS APP.

Step 1 Go to **Configuration > Network > Advanced Settings > Wi-Fi AP**.

Step 2 Check **Enable Wi-Fi AP**, **Enable AP Broadcast**, and **Enable WLAN HotSpot**.

Step 3 Configure hotspot parameters.

- 4) Enter **SSID** (hotspot name).
- 5) Select **Security Mode**.
- 6) Enter **IP Address** and **Sub-net Mask**.

Note

The IP address must be in different network segment with TCP/IP address.

Step 4 Attach the Wi-Fi antenna to the device.

Step 5 Open the ADAS APP and connect to the recorder Wi-Fi SSID with the password set in Step 3.
The initial password is 1234567890.

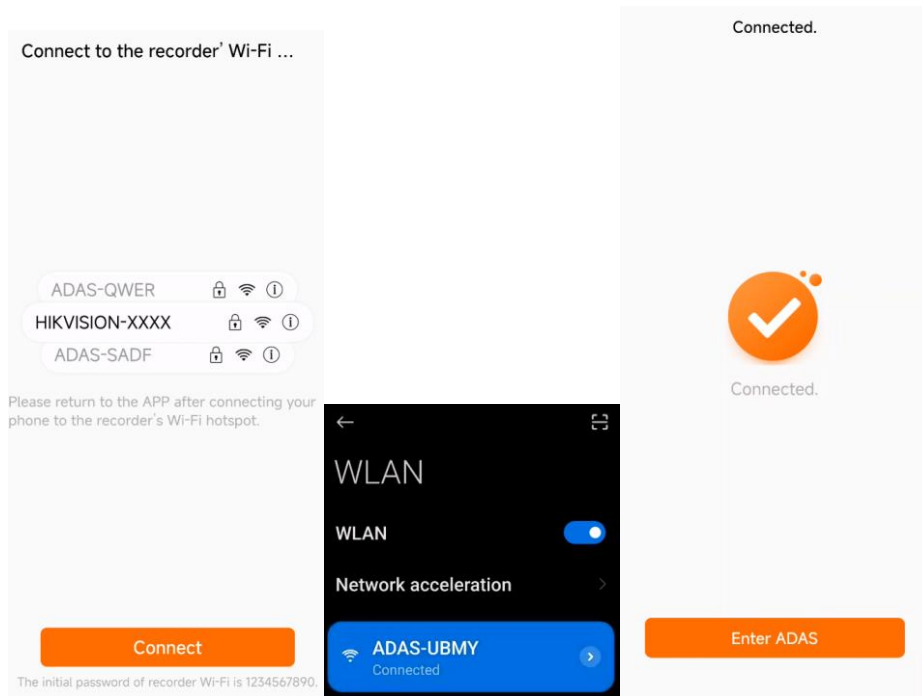

Figure 15-2 Connect to the Recorder Wi-Fi

15.3 Configure Smart Settings

Enter Settings → Smart Settings to configure the smart functions.

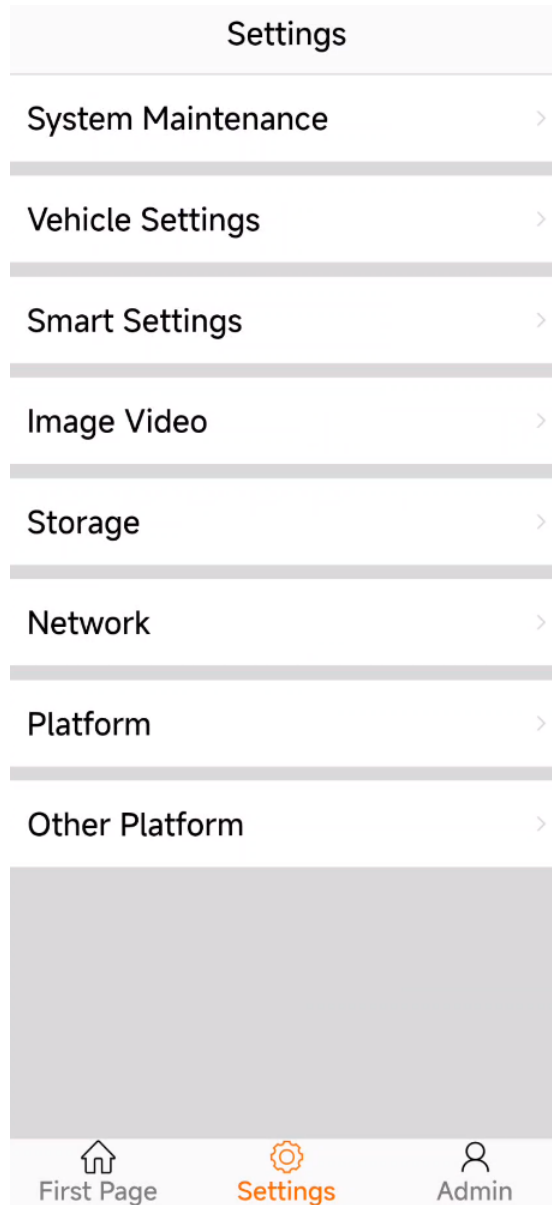

Figure 15-3 Settings

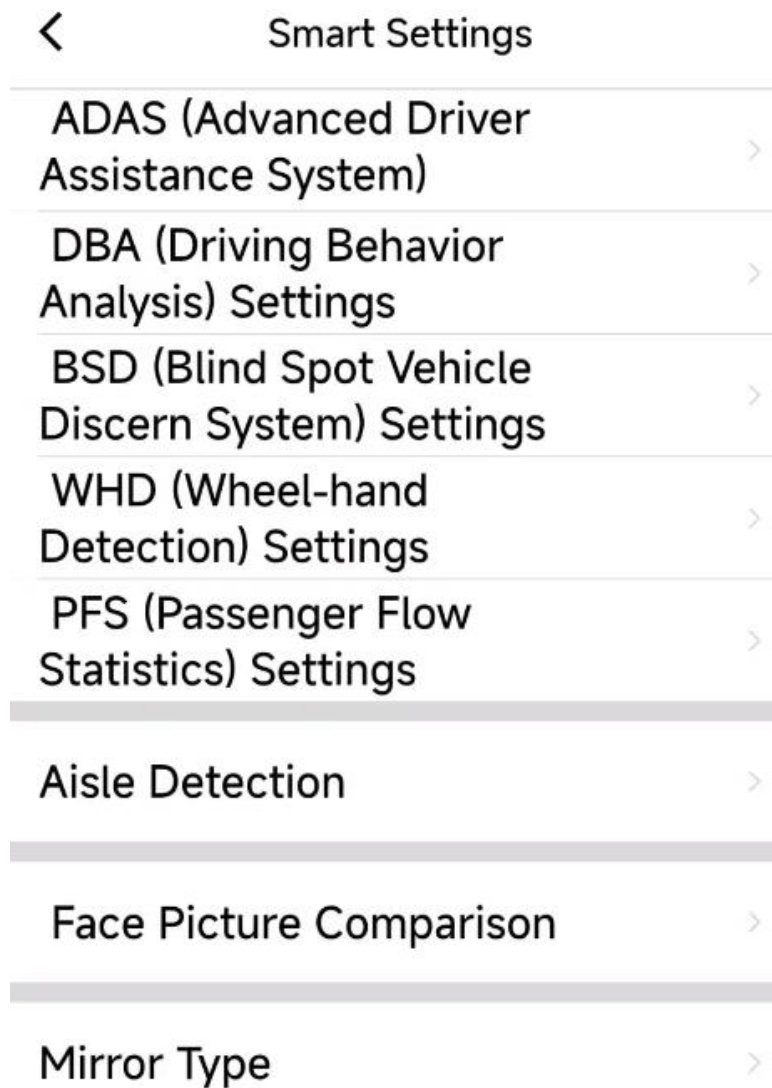

Figure 15-4 Smart Settings

15.4 ADAS Settings

15.4.1 ADAS Parameter Settings

Step 1 Enter Settings → Smart Settings → ADAS Settings.

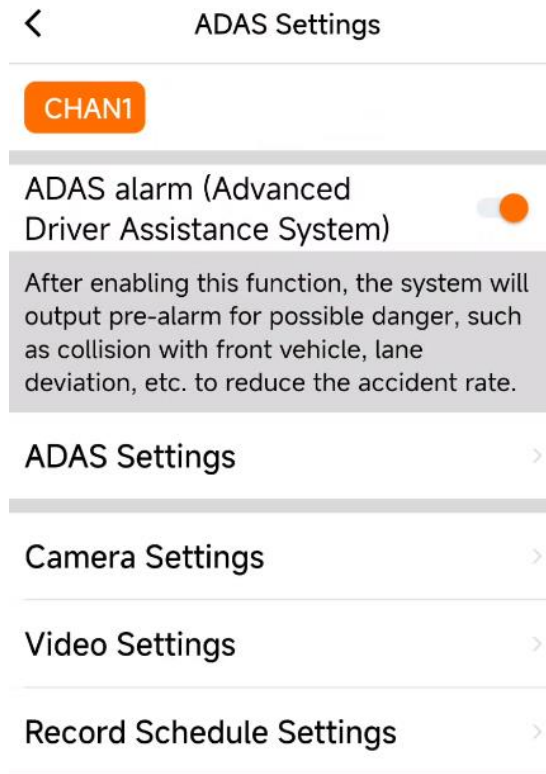

Figure 15-5 ADAS Settings

Step 2 Enable ADAS alarm for various ADAS functions, such as FCW, FDW, HMW, PCW and TSR.

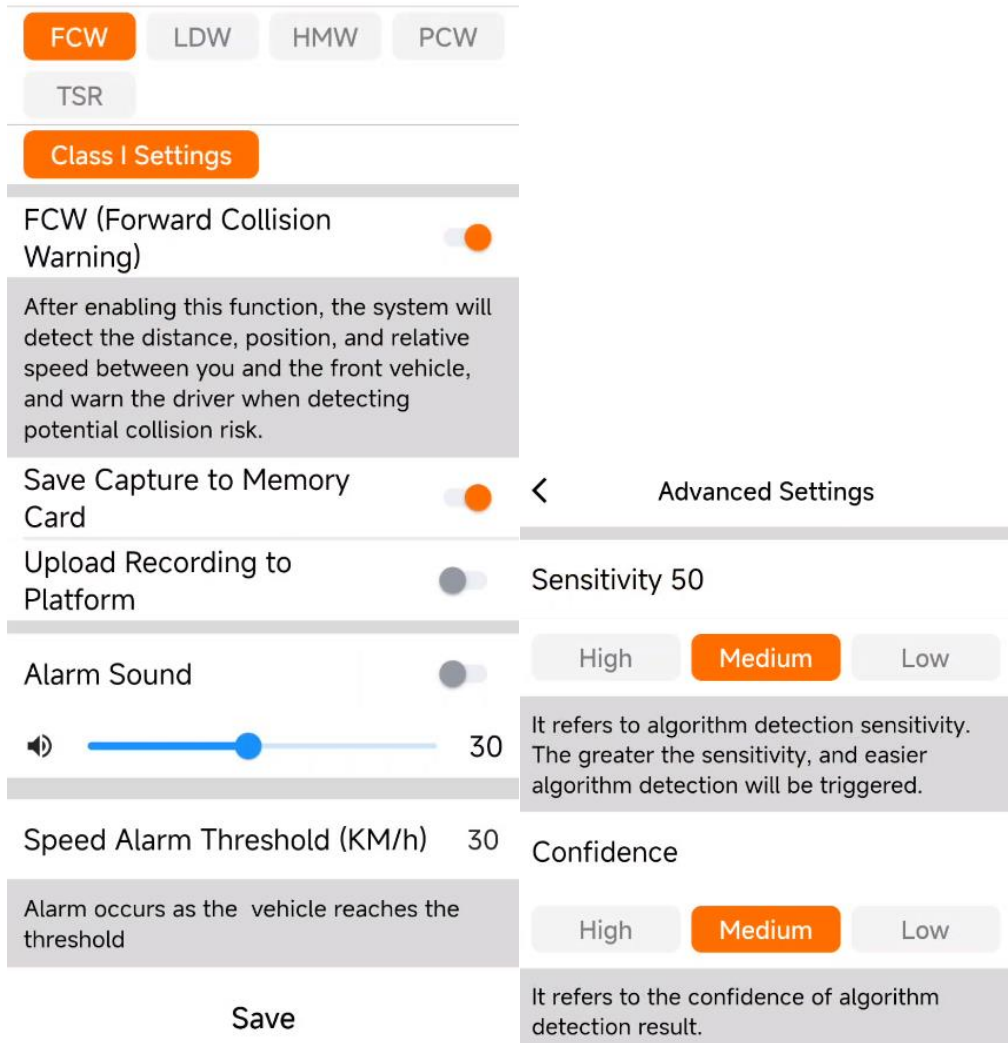

Figure 15-6 ADAS Parameter Settings and Advanced Settings

Class I/II Settings: the higher, the more dangerous.

Enable Function: if unchecked, then alarm will not be enabled.

Alarm sound: the loudness of the alarm.

Speed Alarm Threshold: the minimum speed for the alarm to function.

In the advanced settings, you can configure the sensitivity and confidence of the ADAS algorithm.

Sensitivity: the higher the more easier to trigger alarm.

Confidence: the higher, the more accurate the alarm.

15.4.2 Camera Settings

Enter the installation data of the ADAS camera.

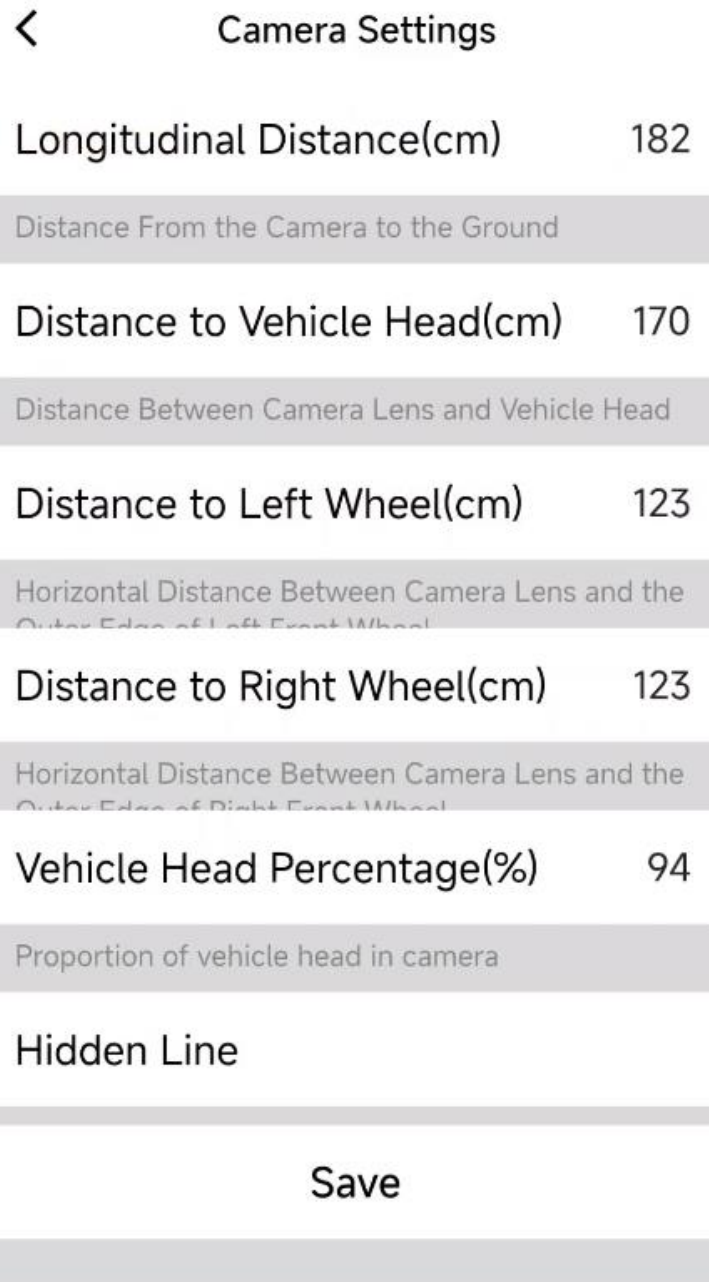

Figure 15-7 Camera Settings

Tap Hidden Line to start calibrate the camera.

Following the instruction of the tutorial.

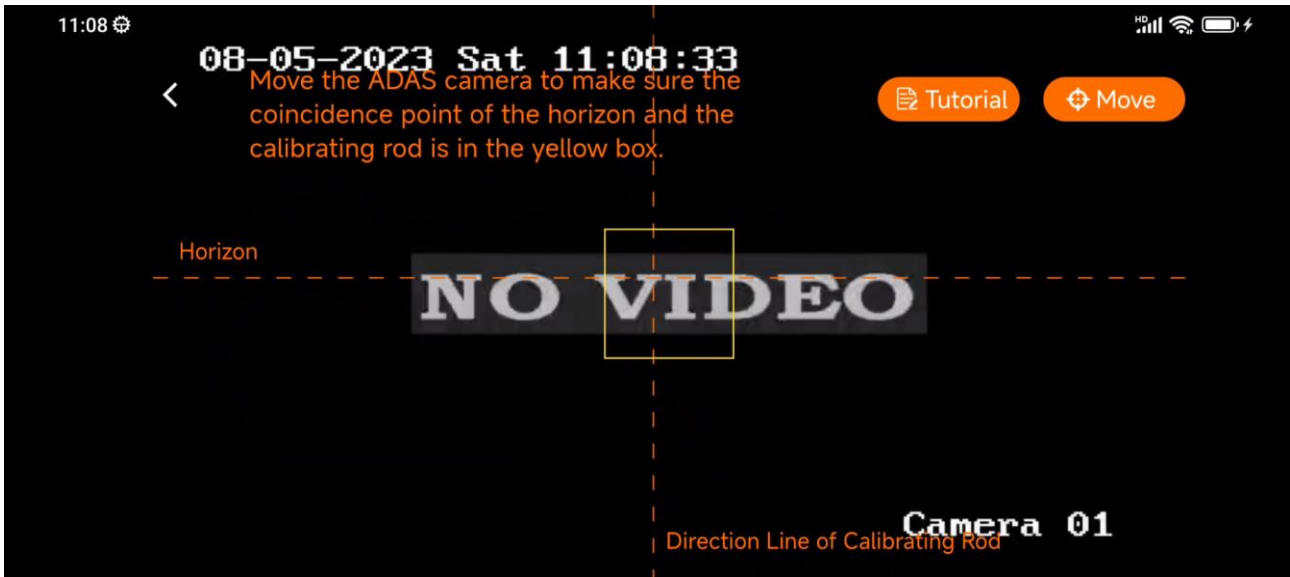
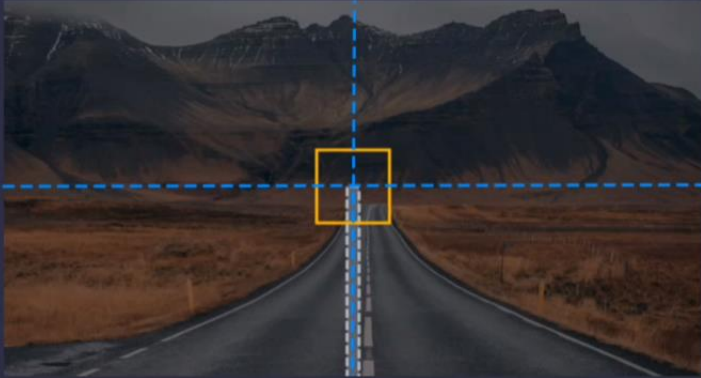

Figure 15-8 Calibration Interface



Figure 15-9 Calibration Step 1: Calibration Rod

Tutorial



Step 2

Move the ADAS camera to make sure the coincidence point of the horizon and the

[Last Step](#) [Next](#)

Figure 15-10 Calibration Step 2: Adjust ADAS Camera

Tutorial

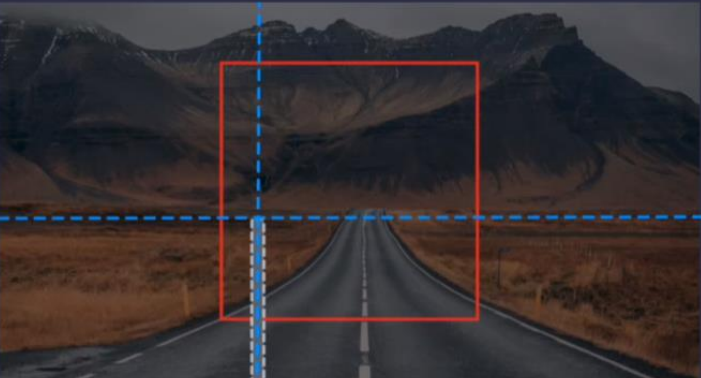

i If you failed on step 2

Click Move on your APP to make sure the coincidence point of the horizon and the

[Last Step](#)

Figure 15-11 Last Calibration Step

15.4.3 Video Settings

In Video Settings, you can configure the stream type, bit rate type, compression format, resolution, image quality, frame rate, max bit rate for the selected channel.

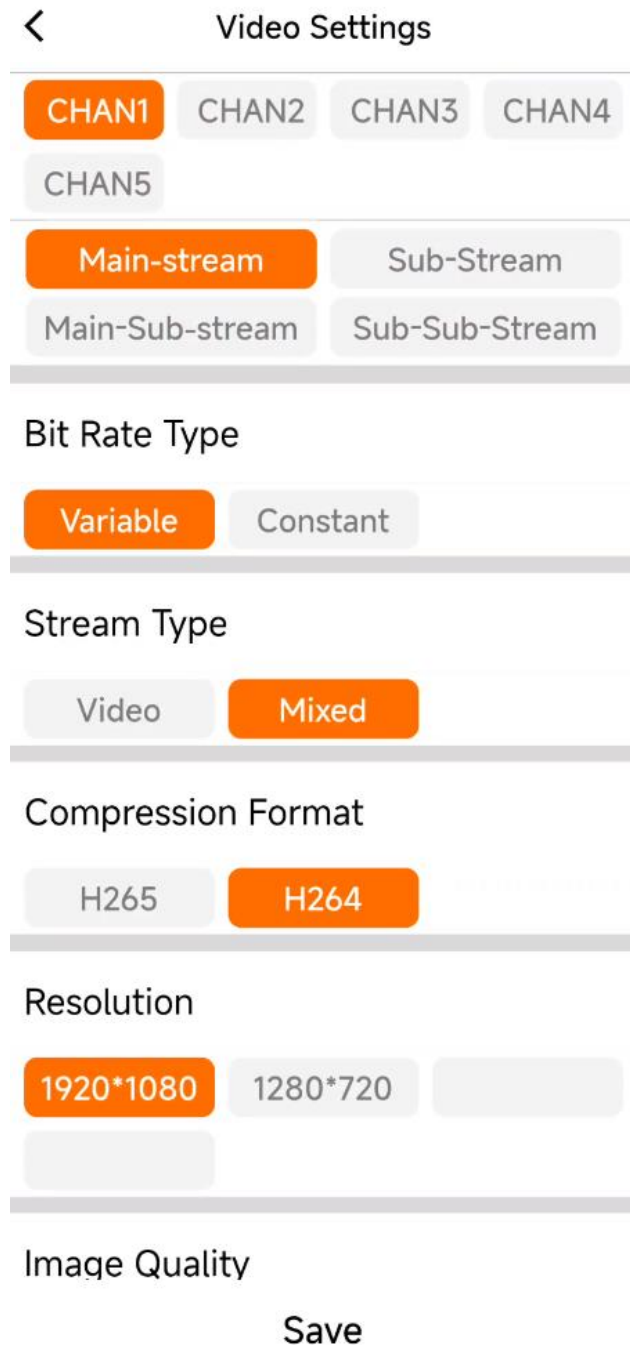

Figure 15-12 Video Settings

15.4.4 Recording Schedule Settings

In Recording Schedule Settings, you can set the start and end time of video recording and then copy the schedule of one day to the rest.

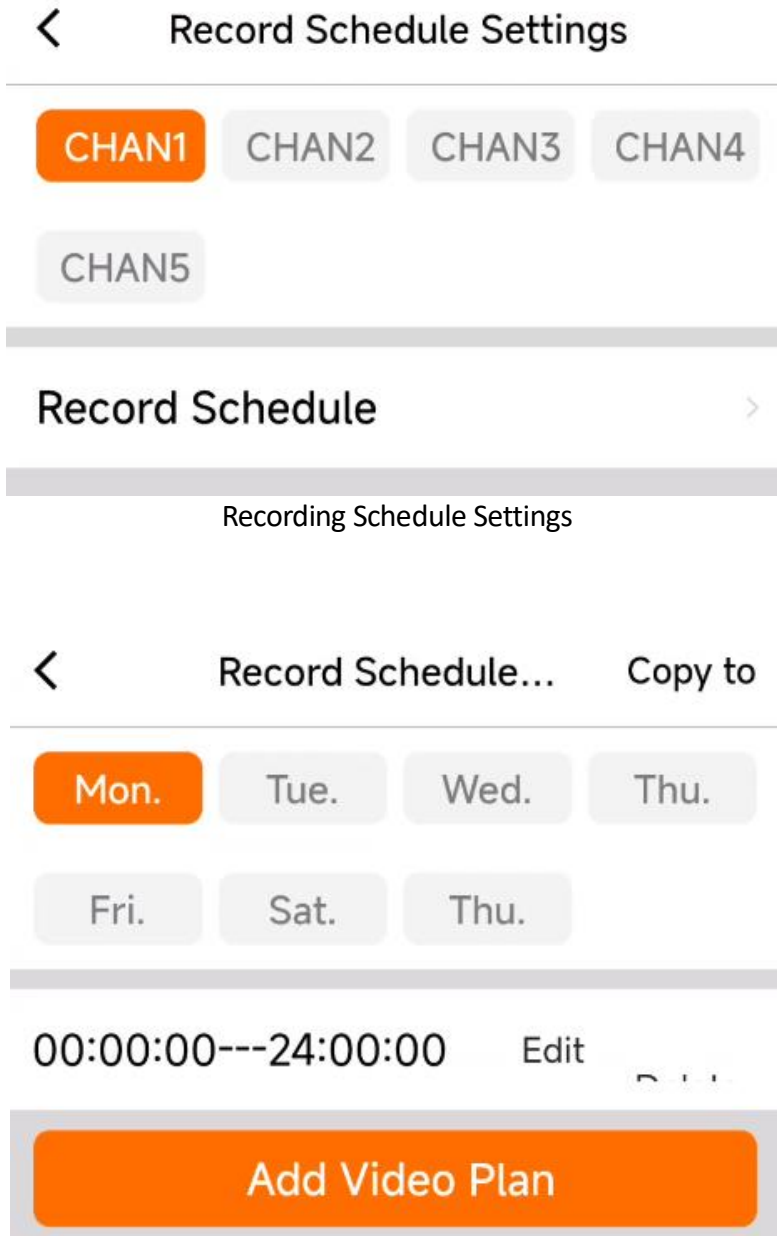

Figure 15-13 Add Recording Schedule

Copy video plans to...

- Tue.
- Wed.
- Thu.
- Fri.
- Sat.
- Thu.

Figure 15-14 Copy Recording Schedule Settings

15.5 DBA Settings

15.5.1 DBA Parameter Settings

Step 1 Enter Settings → Smart Settings → DBA Settings.

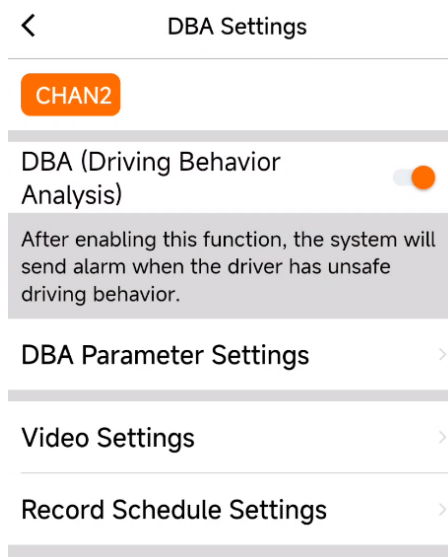

Figure 15-15 DBA Settings

Step 2 Configure DBA Parameter Settings.

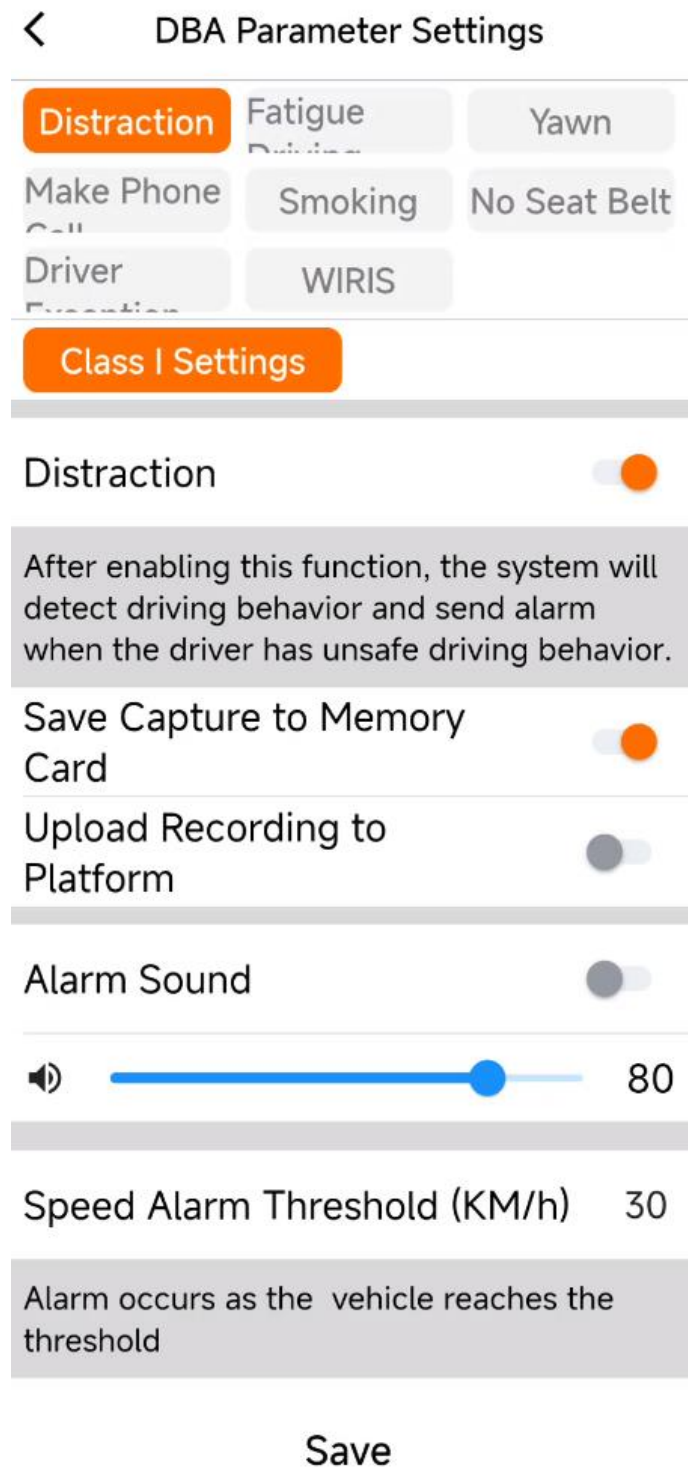

Figure 15-16 DBA Parameter Settings

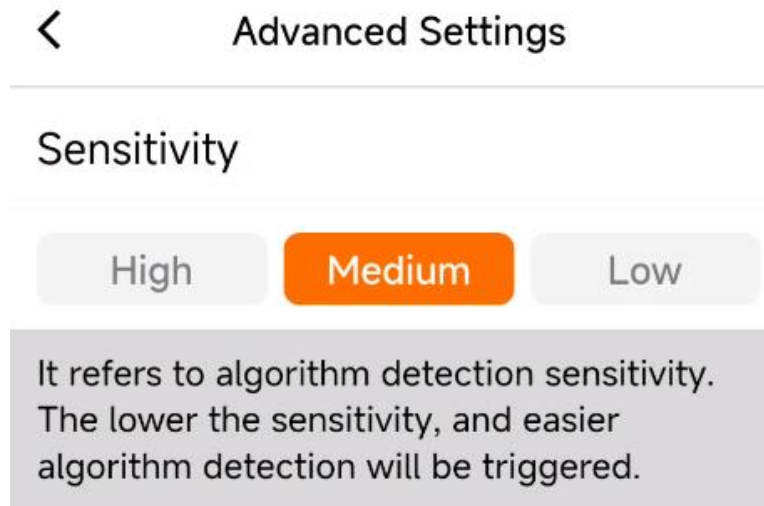

Figure 15-17 Advanced Settings

15.5.2 Video and Recording Schedule Settings

Refer to 15.4.3 for Video Settings and 15.4.4 Recording Schedule Settings.

15.6 BSD Settings

15.6.1 BSD Parameter Settings

Step 1 Enter Settings → Smart Settings → BSD Settings.

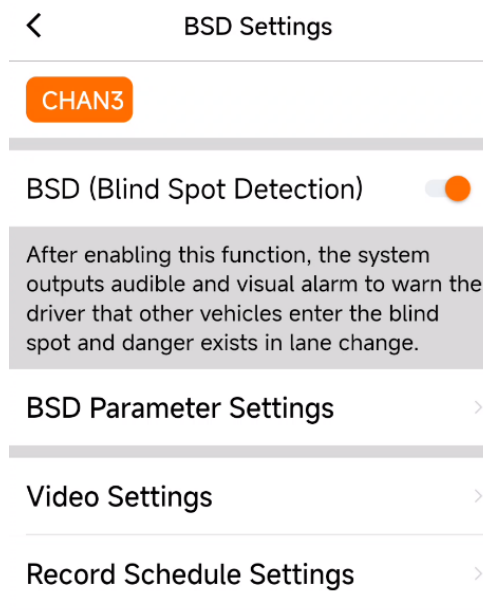

Figure 15-18 BSD Settings

Configure BSD Parameter Settings.

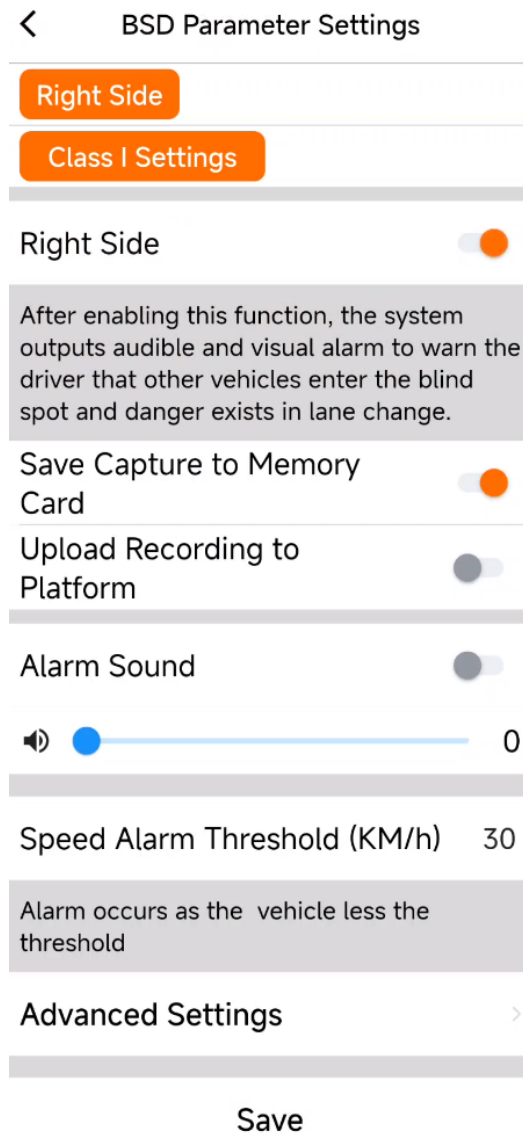

Figure 15-19 BSD Parameter Settings

15.6.2 Advanced Settings

You can set BSD camera algorithm and calibration.

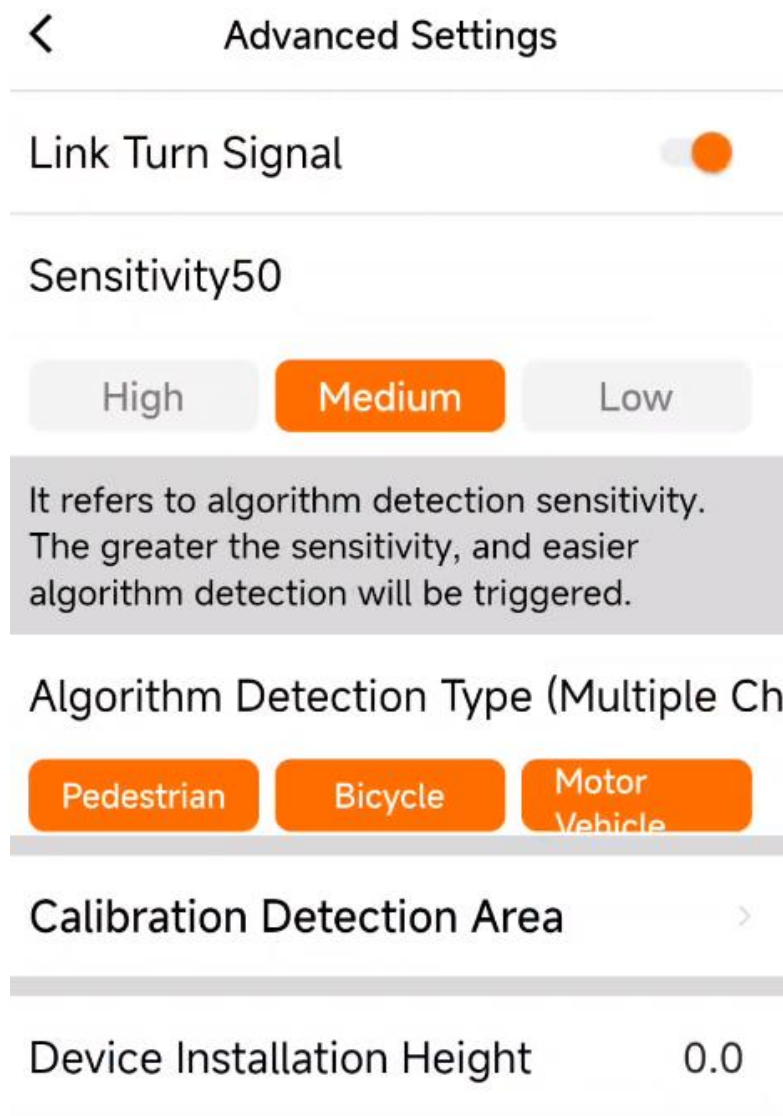
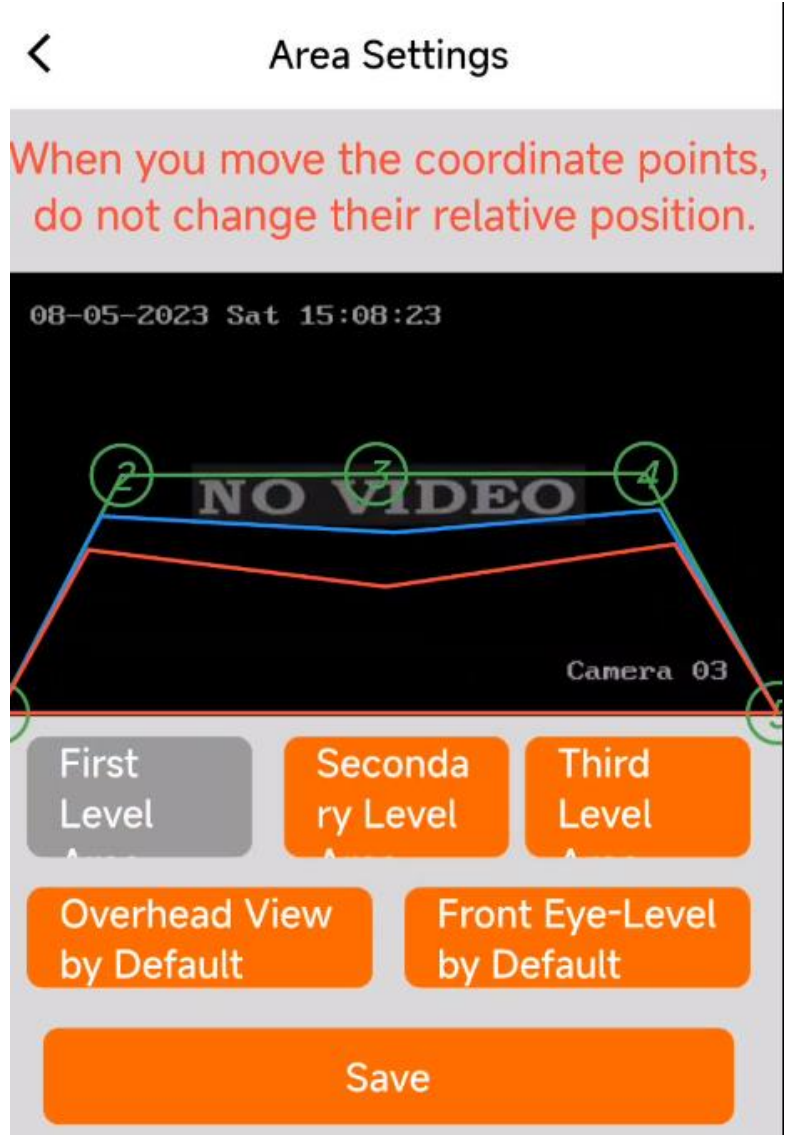

Figure 15-20 Advanced Settings

Sensitivity: the higher, the easier to trigger alarm.

Link Turn Signal: BSD will only function when the right turn signal is on.

15.6.3 Calibration Detection Area



Calibration Detection Area

Step 1 Make sure the bottom line is parallel to the side of the vehicle and limit it to less than 10% of the image.



Figure 15-21 Camera Angle Adjustment

Step 2 First level (Maxima) is along the side of the vehicle, the furthest part is about 2.5 m to the vehicle body and parallel to the vehicle. Recommend to use the default value of the 2nd and 3rd level.



Figure 15-22 Set Detection Area

When the vehicle speed is lower than the set value and the pedestrian or vehicle enters the detection area, then the BSD alarm will be triggered.

15.6.4 Video and Recording Schedule Settings

Refer to 15.4.3 for Video Settings and 15.4.4 Recording Schedule Settings.



See Far, Go Further