

Model No.GA9070 230MM ANGLE GRINDER

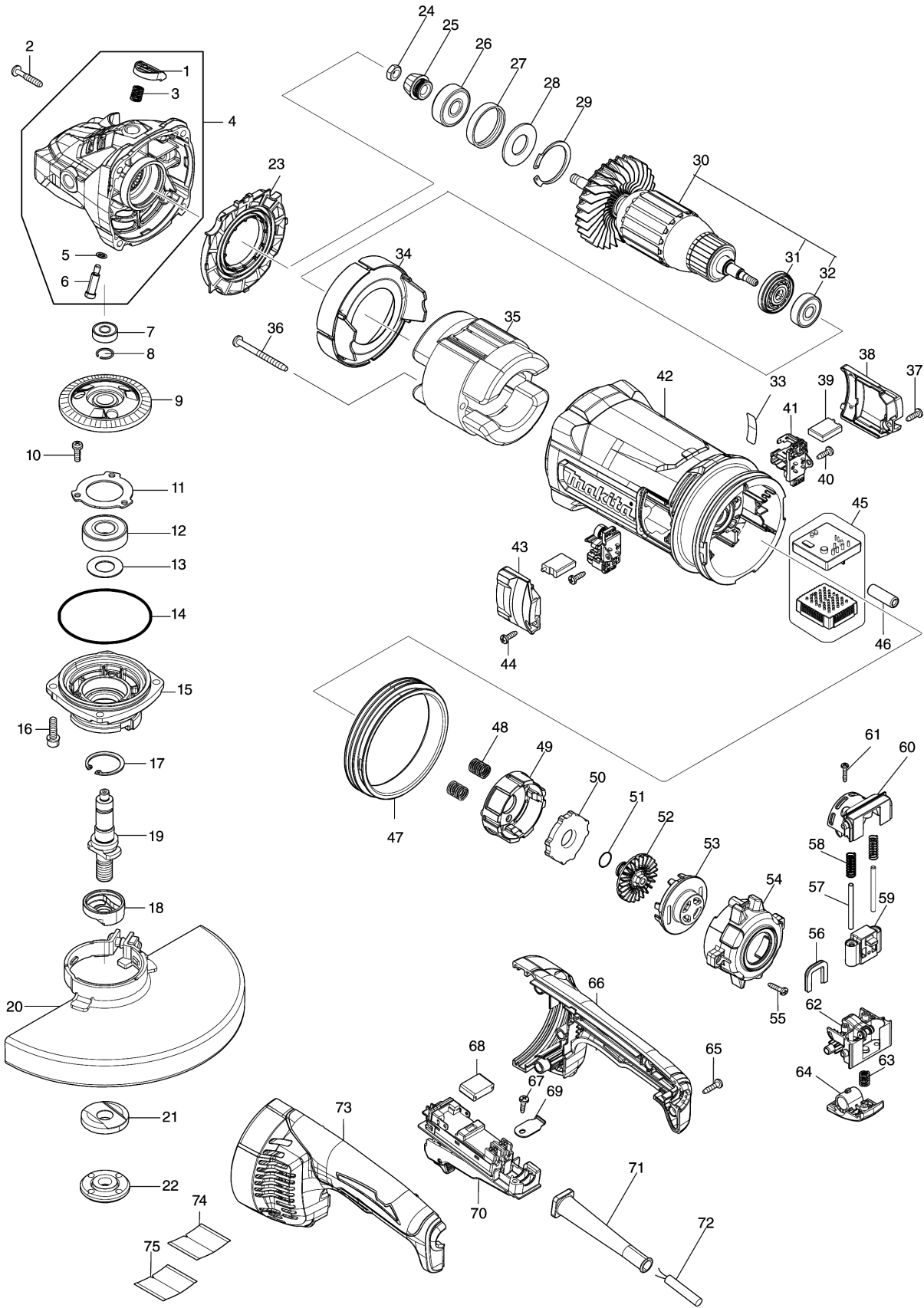

Model No.GA9070 230MM ANGLE GRINDER

Položka	Číslo dílu	Popis	Změna	Množství	New/Old	Možnost 1	Možnost 2	Poznámka
001	456247-8	PIN CAP		1				
002	266553-1	TAPPING SCREW 5X30		4				
003	234391-9	COMPRESSION SPRING 8		1				
004	140Y89-7	GEAR HOUSING COMPLETE		1				
C10	263002-9	RUBBER PIN 4		1				
C20	262118-7	FELT RING 18		1				
D10		INC. 1,3,5,6						
005	213026-5	O RING 7		1	*			
005-1	213A14-8	O-RING7	O	1				
006	256571-7	SHOULDER PIN 7		1				
007	211032-4	BALL BEARING 608ZZ		1				
008	233925-5	RING SPRING 13		1				
009	227653-2	SPIRAL BEVEL GEAR 54		1				
010	265120-9	PAN HEAD SCREW M5X16		3				
011	285741-1	BEARING RETAINER 50		1				
012	211278-2	BALL BEARING 6203DDW		1				
013	267487-1	FLAT WASHER 17		1				
014	213760-7	O RING 78		1				
015	312A97-6	BEARING BOX		1				
016	265541-5	HEX. SOCKET HEAD BOLT M6X22		4				
017	962151-6	RETAINING RING R-32		1				
018	310800-3	LEAD FLANGE		1				
019	327762-8	SPINDLE		1				
020	122891-0	WHEEL COVER 230K ASSEMBLY		1				
C10	213017-6	O RING 6		1				
C20	265198-2	+PAN HEAD SCREW M8X25		1				
021	224447-6	INNER FLANGE 42B		1				
022	224485-8	LOCK NUT 14-45		1				
023	456238-9	DIFFUSER		1				
024	252194-9	HEX. NUT M8		1				
025	227652-4	SPIRAL BEVEL GEAR 13		1				
026	211132-0	BALL BEARING 6301DDW		1				
027	262085-6	RUBBER RING 38		1				
028	267299-2	FLAT WASHER 20		1				
029	962211-4	RETAINING RING R-42		1				
030	511A14-5	ARMATURE ASS'Y 220-240V		1				
C10	240161-6	FAN 86		1				
D10		INC. 31,32						
031	681025-9	INSULATION WASHER		1				
032	210267-4	BALL BEARING 6200DDW		1				
033	811P30-0	GA9070 SERIAL NO. LABEL		1				
034	456239-7	BAFFLE PLATE		1				
035	621924-3	FIELD 240V		1				
036	266044-2	TAPPING SCREW 5X60		2				

Model No.GA9070 230MM ANGLE GRINDER

Položka	Číslo dílu	Popis	Změna	Množství	New/Old	Možnost 1	Možnost 2	Poznámka
037	266385-6	TAPPING SCREW 4X14		1				
038	183T24-2	BRUSH HOLDER COVER SET		1				
D10		INC. 43						
039	191T31-1	CARBON BRUSH SET		1				
040	266385-6	TAPPING SCREW 4X14		2				
041	644001-4	BRUSH HOLDER		2				
042	413343-5	MOTOR HOUSING		1				
043	183T24-2	BRUSH HOLDER COVER SET		1				
D10		INC. 38						
044	266385-6	TAPPING SCREW 4X14		1				
045	620D47-8	CONTROLLER		1				
046	688165-4	LINE FILTER		1				
047	422671-7	VIBRATION PROOF RUBBER		1				
048	232677-5	COMPRESSION SPRING 10		2				
049	312A98-4	SHOE HOLDER		1				
050	422672-5	BRAKE SHOE		1				
051	213118-0	O RING 12		1				
052	313360-4	FAN 45		1				
053	413388-3	SHOE HOLDER CAP		1				
054	140Y86-3	SHOE HOLDER COVER COMPLETE		1				
C10	263027-3	RUBBER PIN 4		2				
055	266326-2	TAPPING SCREW 4X18		2				
056	422669-4	LINK SEAL		1				
057	256225-6	PIN 4		2				
058	232676-7	COMPRESSION SPRING 7		2				
059	140Y87-1	SLIDE RALL COMPLETE		1				
060	413381-7	UPPER LINK CASE		1				
061	266130-9	TAPPING SCREW BIND PT 3X16		2				
062	140Y88-9	LOWER LINK CASE COMPLETE		1				
063	233375-4	COMPRESSION SPRING 7		1				
064	413389-1	LOCK BUTTON		1				
065	266326-2	TAPPING SCREW 4X18		4				
066	183T22-6	HANDLE SET		1				
D10		INC. 73						
067	266385-6	TAPPING SCREW 4X14		1				
068	645088-9	NOISE SUPPRESSOR		1				
069	687169-3	STRAIN RELIEF		1				
070	632S37-9	SWITCH UNIT		1				
071	682573-1	CORD GUARD 10		1				
072	695107-1	POWER SUPPLY CORD 1.5-2-2.5		1				
073	183T22-6	HANDLE SET		1				
D10		INC. 66						
074	811P26-1	GA9070 NAME PLATE		1				
075	8037A3-0	CLEAR LABEL		1				

Please order the parts with part number.

Print Date 19/11/2021

Model No.GA9070 230MM ANGLE GRINDER

Položka	Číslo dílu	Popis	Změna	Množství	New/Old	Možnost 1	Možnost 2	Poznámka
A01	162264-5	VIBRATION PROOF GRIP		1				
A02	782034-2	LOCK NUT WRENCH 35		1				

Please order the parts with part number.

Print Date 19/11/2021